

Kofax Kapow

User's Guide

Version: 10.0.0

Date: 2016-09-20

© 2007-2016 Kofax, Inc., 15211 Laguna Canyon Road, Irvine, California 92618, U.S.A. All rights reserved. Use is subject to license terms.

Copyright (C) 2004- 2016 Kapow Technologies, Inc. All rights reserved. Use is subject to license terms. Unauthorized duplication or distribution is strictly prohibited.

Third-party software is copyrighted and licensed from Kofax's suppliers. For information on third-party software included in this product, see <documentation/thirdparty.html> located in your Kapow installation folder.

This product is protected by U.S. Patent No. 6,370,277.

THIS SOFTWARE CONTAINS CONFIDENTIAL INFORMATION AND TRADE SECRETS OF KOFAX, INC. USE, DISCLOSURE OR REPRODUCTION IS PROHIBITED WITHOUT THE PRIOR EXPRESS WRITTEN PERMISSION OF KOFAX, INC.

Kofax, the Kofax logo, and the Kofax product names stated herein are trademarks or registered trademarks of Kofax, Inc. in the U.S. and other countries. All other trademarks are the trademarks or registered trademarks of their respective owners.

U.S. Government Rights Commercial software. Government users are subject to the Kofax, Inc. standard license agreement and applicable provisions of the FAR and its supplements.

You agree that you do not intend to and will not, directly or indirectly, export or transmit the Software or related documentation and technical data to any country to which such export or transmission is restricted by any applicable U.S. regulation or statute, without the prior written consent, if required, of the Bureau of Export Administration of the U.S. Department of Commerce, or such other governmental entity as may have jurisdiction over such export or transmission. You represent and warrant that you are not located in, under the control of, or a national or resident of any such country.

DOCUMENTATION IS PROVIDED "AS IS" AND ALL EXPRESS OR IMPLIED CONDITIONS, REPRESENTATIONS AND WARRANTIES, INCLUDING ANY IMPLIED WARRANTY OF MERCHANTABILITY, FITNESS FOR A PARTICULAR PURPOSE OR NON-INFRINGEMENT, ARE DISCLAIMED, EXCEPT TO THE EXTENT THAT SUCH DISCLAIMERS ARE HELD TO BE LEGALLY INVALID.

Table of Contents

Training	9
Getting Help for Kofax Products	10
Welcome to Kapow Help	11
Common Starting Points	11
Introduction to Kapow	12
Kapow Compute Units	12
License Keys	13
Kapow Limitations	14
Getting Support	16
Tutorials	17
Beginner Tutorials	17
Introduction	17
Robot Beginner's Tutorial	18
Kapplet Beginner's Tutorial	21
Type Beginner's Tutorial	23
Advanced Tutorials	24
Branches, Robot States, and Execution Flow	24
Looping Basics	26
Try Step	31
Excel	33
Data Conversion	36
Patterns	38
Snippets	43
Date Extraction - Simple Case	46
Date Extraction - Tricky Case	47
API	48
Design Studio	52
Introduction to Design Studio	52
Robots	53
Snippets	62
Variables and Types	62
Libraries and Robot Projects	63
Naming policy	64

Device Automation	65
Design Studio User Interface	67
Menu Bar	68
Toolbar	70
My Projects View	72
Shared Projects View	72
Databases View	73
Editors View	74
Robot Editor	74
Type Editor	79
Text Editor	79
General Editing	79
Types	81
Type Attributes	82
Step Actions and Data Converters	83
Patterns	83
Expressions	86
Experiment with Expressions	87
Edit Expressions	88
Projects and Libraries	89
Manipulate Robot Projects	91
Organize Robot Files	91
Work with Shared Projects	92
Interact with Databases	93
Map Databases	93
Types and Databases	95
Database Warnings	95
Create Database Tables	96
Store Data in Databases	97
Robot Structure	100
Write Well-Structured Robots	101
Determine the Page Type	103
Use Tag Finders	104
Tag Paths	104
Tag Finder Properties	106
Configure Tag Finders	107
Submit a Form	107
Form Basics	108

Determine the Step Action	110
Use the Loop Form Actions	110
Upload Files	111
Use the Context Menu on the Page View	112
Loop Through Tags on a Page	112
Loop Through Tags with the Same Class	112
Loop Through Tags with Different Classes	114
Loop Through HTML Pages	116
First Page Links to All Other Pages	116
Each Page Links to Next	117
Use Wait Criteria	119
Extract Content from HTML	124
Extract Text	125
Extract Binary Data	125
Use the Context Menu in the Page View	126
Perform Common Tasks	126
Extract Content From an HTML Table	129
Handle Table Content Irregularities	129
Handle Table Structure Irregularities	130
Local Files Usage in Robots	131
Load an Excel Page from a Variable	132
Extract Content from Excel	134
Extract Values from Cells	134
Extract a Sheet Name	135
Extract as HTML	136
Test Cell Types in Excel	136
Loop in Excel	138
Loop Over Sheets and Rows	139
Loop Over Merged Cells	140
Work with Variables in the Windows View	141
Open a Variable	142
Modify a Variable	143
Work with JSON	144
JSON Terminology	144
JSON MIME Type	145
JSON and Step Actions	145
JSON as a JavaScript Object	147
Handle Errors	148

Error Handling Alternatives	148
Shortcuts for Common Cases	150
At Target	151
Looping	153
Try Catch	154
Identify Error Handling in Robot View	155
Create and Reuse Snippets	155
Variables and Snippets	156
Snippet Best Practices	158
Make Robust Robots	159
Reuse Sessions	159
Modify an Existing Type	161
Configure Robots	161
Show Changes from Default Robot Configuration	162
Migrate a Robot to a Different Browser Engine	166
Migrating a Robot to the Classic Browser	166
Migrating a Robot to the Default Browser	167
Configure Variables	167
Use Device Automation	170
Device Automation Workflow	170
Configure Automation Device	170
Automation Device Mapping	174
Use Terminals with Device Automation	175
Expressions in Device Automation	177
Variables in Device Automation	178
Debug Robots	179
Basic Debugging	179
Debug from the Current Location in Design Mode	181
Return to Design Mode from a Debugging Location	181
Use Breakpoints	181
Single Stepping	182
Step Into	182
Design Studio Settings	182
General	183
Text Files	184
Robot Editor	185
Local Databases	187
Proxy Servers	188

Certificates	190
Bug Reporting	192
Management Consoles	193
Management Console	195
Introduction to Management Console Structure	195
Naming Policy	196
Start the Management Console	196
Management Console Configuration and User Interface	197
Dashboard	197
Kapplets	199
Schedules	200
Repository	208
Data	219
Logs	220
Admin	222
Add Database Type	245
JMX	246
OAuth	246
Supported Service Providers	246
Add Applications	247
Add Users	249
Write Robots	252
Schedule Robots with Credentials	254
Out of Band Applications	255
Kapow Kapplets	257
Building and Maintaining Kapplets	257
Creating Kapplets	257
Using the Kapplet Studio	258
Installing and Using Kapplets	262
Invoking Kapplets	262
Creating Email Notifications from Kapplets	263
Scheduling Kapplets	264
Customizing Kapplet Branding	264
Reference	265
Design Studio	265
Step Action	265
Data Converters	384
The Type Editor	424

Creating and Deleting Tables	429
Protocols	429
Robot Libraries	430
Upload to Management Console	431
Other Topics	431
RoboManager	474
User Interface	474
RoboServer	477
Start RoboServer	477
RoboServer Configuration	480
RoboServer Configuration - Headless Mode	481
Management Console	484
Other Topics	484
Environments	486
Robot Info Environments	487
Storage Environments	488
Message Environments	490
Input Configuration	491
Common Robot Environment	492
Java API	493
Using Proxy Services	493

Training

Kofax offers both classroom and computer-based training to help you make the most of your Kapow solution. Visit the Kofax website at www.kofax.com for details about the available training options and schedules.

Getting Help for Kofax Products

Kofax regularly updates the Kofax Support site with the latest information about Kofax products.

To access some resources, you must have a valid Support Agreement with an authorized Kofax Reseller/ Partner or with Kofax directly.

Use the tools that Kofax provides for researching and identifying issues. For example, use the Kofax Support site to search for answers about messages, keywords, and product issues. To access the Kofax Support page, go to www.kofax.com/support.

The Kofax Support page provides:

- Product information and release news
Click a product family, select a product, and select a version number.
- Downloadable product documentation
Click a product family, select a product, and click **Documentation**.
- Access to product knowledge bases
Click **Knowledge Base**.
- Access to the Kofax Customer Portal (for eligible customers)
Click **Account Management** and log in.

To optimize your use of the portal, go to the Kofax Customer Portal login page and click the link to open the *Guide to the Kofax Support Portal*. This guide describes how to access the support site, what to do before contacting the support team, how to open a new case or view an open case, and what information to collect before opening a case.

- Access to support tools
Click **Tools** and select the tool to use.
- Information about the support commitment for Kofax products
Click **Support Details** and select **Kofax Support Commitment**.

Use these tools to find answers to questions that you have, to learn about new functionality, and to research possible solutions to current issues.

Chapter 1

Welcome to Kapow Help

Use the help to get assistance for all components of Kofax Kapow.

Common Starting Points

To get more information about Kapow modules or components, use any of the following links.

- [Introduction to Kapow](#)
- [Design Studio](#)
- [Management Console](#)
- [Kapow Kapplets](#)
- [Reference](#)

Chapter 2

Introduction to Kapow

Kapow is a platform for application integration and process automation. It can integrate applications that weren't built to be connected and automate processes across such heterogeneous systems; cloud/SaaS applications with premise systems, legacy systems with modern web applications, back office systems with partner websites.

With our visual editor Design Studio (pictured), you click through the applications and data sources you want to integrate and create an automated workflow.

Kapow Visual Editor: Design Studio

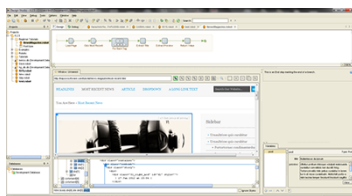

In Kapow, these workflows are known as robots. As you build a robot, you are free to navigate through the applications as you integrate them. You can login to applications, extract data parts of a page, enter data into forms or search boxes, make menu selections, and scroll through multiple pages. Your robot can also access databases, files, APIs, and web services, exporting data from one application and loading it into another; transforming data as necessary along the way.

Once built, robots are uploaded to a repository in the Management Console. From here, they can be scheduled for batch-execution on the RoboServer or executed on-demand via Java or C# APIs, tailored REST services that are instantaneously available once the robots have been added to the repository, or exposed as special-purpose end-user web applications called Kapplets.

The Management Console is also responsible for load balancing, failover, monitoring of RoboServer health and management of user roles and permissions.

Kapow Compute Units

Kapow licensing now uses capacity based pricing based on Kapow Compute Units (KCU) instead of CPU core based pricing used in earlier versions. This pricing model is completely independent of the chosen hardware configuration.

What are KCUs?

A KCU is a Kapow Compute Unit and is defined as a unit of measure for how many operations (or steps) a Kapow RoboServer can perform in one second (and is unrelated to underlying server capacity).

A step is the smallest unit of action which can be performed within a RoboServer. Examples of steps are, loading a web page, writing a data record to a database, or performing a transformation on a data element.

One KCU represents a total of 5000 KCU points per second. The number of Kapow steps that make up one (1) KCU depends on the type of Kapow steps involved, as each step type consumes a different amount of the KCU. The steps are divided into groups the most important groups are listed here:

1. Steps that both do I/O and execute JavaScript, 10000 KCU points, for example, 2 page loads per second with 4 KCUs
2. Steps that do either I/O or execute JavaScript (but not both), 1000 KCU points, for example, 20 Call REST Web Service Steps per second with 4 KCUs
3. Extraction and transformation steps 1 KCU point, for example, 40,000 extract or assign steps per second with 4 KCUs

(The complete list is available in Design Studio by clicking the Help->KCU Information menu item)

The above is provided that you have enough CPU power and sufficiently low response time from the source server. (Note: We have empirically measured the average page load time on a powerful CPU over the 23000 most visited web sites to 6.7 seconds).

The total number of KCUs a robot uses can be seen in the Design Studio Debugger Summary information after running the robot.

Deploying and Assigning KCUs

With KCUs we can deliver the needed computing capacity independent of the target hardware environment and physical CPUs. This allows the flexibility of choosing, cloud-based or on-premise, virtualized or physical CPU environments without the need to control the number of allocated CPUs.

The available KCUs are assigned to the RoboServer Clusters in the Management Console and automatically distributed between the RoboServers available within the Cluster.

License Keys

Before you can begin using your Kapow installation, you must enter your license key(s) into Management Console as described in the *Kapow Installation Guide*, Management Console (License Server) topic. You will have received these keys from Kapow.

There are three different kinds of license key:

Production key

Permits production use of the Kapow system.

Non-Production key

Permits use of the Kapow system for non-production use like test and staging.

Developer Seat key

A special kind of non-production key that will allow you to run all the Kapow programs on your own computer as part of the same installation. There are, however, some performance limitations, as this is intended to be used only for development or as a trial installation.

A license key (no matter which kind) also describes which Kapow features you have, and how many KCUs you have bought. A Developer Seat key always contains 1 KCU, while the two other kinds may contain more.

If you have both a Production key and a Non-Production key, you may install them into the same Kapow system (that is, in the same Management Console). You may also choose to set up one system for each key. In both cases, you will need to set up at least two different clusters (either on the single system or one cluster on each of the two systems), configured as Production and Non-Production, respectively. The KCUs in your licenses can then be assigned to these clusters.

In no case should a key be entered into more than one Management Console.

Kapow Limitations

The following section describes some limitations of the Kapow product.

Browser

- Kapow uses a browser to interact with web sites or web applications. In fact, Kapow currently comes with two different browsers, each optimized for different purposes - the Classic engine for legacy web applications and the Default engine for modern web applications. However, these browsers - like any other browsers in the market - are not compatible with every internal application or Internet web site.
- The web pages downloaded using Make Snapshot are a representation of the content and styles downloaded from the internal browser in Kapow. When viewing the downloaded pages in a desktop browser, they may render differently from viewing the original web page in that browser.

Excel

- When looping over a global Excel variable, certain step actions are not allowed inside the loop, that is after the loop step. This is dynamically enforced, in other words it is first when the steps are executed that the error occurs. The following step actions will always refuse to work on a global variable that the robot loops over inside the loop: Insert Rows, Insert Columns, Remove Rows, Remove Columns and Set Sheet Name.
- Excel modification is memory intensive and might not work on large Excel documents. The limit may depend on many factors, for example, available memory on a design platform or a server platform, how many modifications the robot does, etc. Therefore it is not possible to give precise criteria for when an Excel document is too large for Kapow to handle.
- Formula support
See <https://poi.apache.org/spreadsheet/formula.html> for details on formula support.
- Unsupported Features
 - Manipulating array/table formulas (In Excel, formulas that look like "{=...}" as opposed to "=...")
 - Region operators: union, intersection
 - Parsing of previously uncalled add-in functions
 - Preservation of whitespace in formulas (when POI manipulates them)
- Sometimes, when your robot performs some actions on a very large Excel document, the processing may become slow after several hundred iterations. To speed up the process, use the following settings in your robot for Excel processing:
 - Use Global variable

- Do not use the Ignore and Continue error handling
- Do not run your robot in Design mode

Caution With all the above-mentioned conditions, if an error occurs when working with Excel, the variable value is set to empty. You will need to inspect your robot to make sure you use the supported Excel capabilities and correct the error to have a valid value in your variable.

See [Supported Features in Excel](#) for more information.

Password Length

All passwords used in the Kapow, for example, passwords for Cluster database, Logdb, Analytics, proxy, and SMTP, must not exceed 117 bytes.

Database

Note the following limitations for IBM DB2 database

- The database must have a "table space" with a page size of at least 8192 KB to create all tables.
- Use "LANGUAGE SQL" for stored procedures. Stored procedures written with "LANGUAGE RPGLE" are not supported.

Execution Mode

The following list contains steps that are not available in the Smart Re-execution [mode](#).

- Call REST Web Service (old version)
- Call Web Service (old version)
- Clear Web Storage
- Crawl Pages
- Crawl Pages (old version)
- Divide Table
- Divide Tag (old version)
- Divide Text
- Divide Text (old version)
- Execute SQL (old version)
- Extract from Excel (old version)
- Extract from PDF (old version)
- Extract Image
- For Each File (old version)
- Hide Tag
- Insert Tag
- Load Data (old version)
- Make Snapshot
- Normalize Table
- Query Database (old version)
- Remove Table Rows
- Remove Tag Range
- Remove Tags

- Remove Tags (old version)
- Replace Tag
- Restore Tag
- Rewrite Page
- Rewrite Style Sheet
- Select File
- Set Top Tag (old version)
- Submit Form
- Transpose Table
- Unhide Tag

General

When collecting a large number of data elements, we recommend you to structure your robot for a divide-and-conquer approach, so that each run of the robot collects only a portion of the data elements.

Getting Support

Customer Support

If you are having any kind of problems using Kapow, please go to <http://services.kofax.com/support> portal that can help you solve problems when using Kapow.

In many of the Kapow applications, you can also send a bug report from within the application. To do this, select Report Bug in the Help menu. Please provide as much information as possible about the bug and what you did just before the bug occurred.

Kofax Customer Portal and Knowledge Base

Kapow customers who are active on maintenance also are entitled to obtain access to the [Kofax Customer Portal](#), which includes solutions to commonly found problems, as well as a Knowledge Base containing implementation tips and tricks, and more.

Support Policy

For support policy, visit the *Kofax End of Sale / End of Support Announcements* page on the Kofax support portal.

Chapter 3

Tutorials

The topics in this section contain links to video tutorials that help you perform different tasks in Kapow. On each tutorial page you can also find a transcript of the video.

Note You need Internet connection to view the video tutorials.

Beginner Tutorials

This section contains several tutorials that provide an overview of Kapow as well as guide you through your first project in this product. Make sure to install and set up Kapow correctly before proceeding with these tutorials. Click the links to videos to play them.

Note You need Internet connection to view the video tutorials.

Introduction

[Introduction tutorial.](#)

This is the first of our beginner tutorials which will guide you safely through your first project with Kapow. In this first video, you will get an overview of the workflow involved when working with Kapow along with an introduction to the main program called Design Studio. Before watching these tutorials, make sure you have installed and set up Kapow correctly. Please follow the relevant parts of the Installation Guide.

Kapow to put it simply is a platform which enables you to fully automate any process that you would be able to perform in a browser via your mouse and keyboard.

Please sit back and watch as you are taken through the general procedure from idea to automated process.

It all starts with an idea of a process you want to automate. In these Beginner Tutorials we want to automatically extract the most recent stories from a website called News Magazine.

Our first step will be to check out the website. What exactly do we want?

When we feel confident about what we want to achieve, we will open Design Studio, the program used to create the automated processes. The first time you open Design Studio you will get a welcome screen which links to this Beginner Tutorial, along with the rest of the documentation. Click OK and you will be able to see the main window of Design Studio.

On the left side we have the projects view. Right now it contains only the default project which includes a collection of example files and a Tutorials folder where samples of the files we will be creating in these Beginner Tutorials can be found.

Double clicking the file called Post.type in the projects view, opens it in the type editor, which is used to edit and create this kind of file. A type defines what kind of data can be stored in a variable of that type. If you are unfamiliar with types and variables, you can think of a variable as a bucket which can hold objects, like text or images, and the type can be thought of as the mold which produces that type of bucket.

This particular type is designed to contain the information we will be extracting from the News Magazine website. In the very last tutorial we will get into the process of creating a type.

The extraction of stories from News Magazine is performed by an automated process called a robot. Think of a robot as an automation of any process you would perform in a web browser.

Double clicking the file called NewsMagazine.robot, also from the Tutorials folder, opens up the robot editor, which is used to edit and create robot files.

The Robot View at the top of the editor displays the structure of the robot. Each step corresponds to an action performed by the robot. Going through the steps in the Robot View the robot loads News Magazine, navigates to the most recent articles and extracts a title and a preview of each story by using a loop. The robot then finally returns the collected values

Clicking the second step in the Robot View executes the Load Page action and we see that News Magazine loads in the Browser View below. As we will see later, the Browser View makes it really intuitive to build a robot.

The next tutorial will show you how to build this robot yourself.

Once we have automated the process of extraction with the robot, we will upload that robot to the Management Console. The Management Console is a web-based application for managing the operational aspects of Kapow. From the robot we can create a Kapplet, which publishes the robot as an app for yourself and others to use.

The final product will be a Kapplet which automatically extracts the most recent stories from News Magazine and returns them for the user to view and download.

You are now ready to start building your first robot. Start the Beginner Tutorials by watching the Robot Beginner's Tutorial.

Robot Beginner's Tutorial

[Robot beginner's tutorial video.](#)

General Introduction

This is the second of four beginner tutorials which will guide you all the way through your first project with Kapow. It is advised to start with the Overview video before starting this tutorial.

You are about to learn how to build a robot in Kapow's Design Studio. Please feel free to follow along on your computer.

Specific Introduction

In Kapow, robots are used to automate processes that can be performed in a web browser. Robots can mimic and automate any set of mouse and keyboard instructions that you would otherwise have to perform manually.

In these beginner tutorials it is the goal to automate the process of extracting the most recent stories from News Magazine which is a site built specifically for these tutorials. There is a link to the site in the text associated with this video. (<http://kapowsoftware.com/tutorial/news-magazine/index.html>.) Under the tab Most Recent News, we find the three most recent articles on News Magazine. From these we want to extract their title and the short article preview that is given. We will design our robot to do all this.

Creating a New Robot

With Design Studio running, create a new robot by right-clicking the default project and choosing **New > Robot...** A window opens, asking for the name of our new robot. Since this is our first robot we will call it MyFirstRobot.robot. Click next. Now direct the robot to the front page of News Magazine (<http://kapowsoftware.com/tutorial/news-magazine/index.html>) and click finish.

The robot editor opens and News Magazine loads. Notice that the new robot file has automatically been selected in the projects view on the left.

The Robot Editor

In the robot editor we have five different main views.

There's the browser view which shows us the loaded page exactly like we'd expect to see it in a browser.

Under the browser view, the html view shows the html of the loaded page.

At the very top there's the robot view where you can see the actions performed by the robot. Actions can be anything from clicking a link to storing data in a database. The active step is highlighted in green and steps to the left of the active step have been executed. Right now the End-step, which is the small round step, is the active step and the load page step has been executed. We will get back to the meaning of the End-step later on.

The step view on the right is used to configure the action performed by the active step. Since our current active step, the End-step, does not have any properties to configure, the step view contains only a description of the step.

Finally the variables view specifies any variables used by the robot for input, output or for storing data during execution.

The Browser View

Use the browser view to navigate to the page we want to extract from. A double click in the browser view corresponds to a single click in a regular browser. Double click the Most Recent News tab to get to the stories we want to extract.

Notice that a new step is created and executed in the robot view and the Most Recent News page is loaded in the browser view.

Scroll down the page and see the three news articles that we want to extract from.

If we single-click within the browser view, a green box appears around the HTML tag in which we have clicked. This green box marks the selected tag in the browser view. By selecting a tag and right clicking it,

a menu appears which presents some actions that can be applied to the selected tag. We will use this in a moment.

Looping Through Tags

The next step is to make a loop which iterates through the three most recent articles. To do this we simply select any tag within the tag of the first article. Select for example the picture. Now, right-click in the selected tag and choose **Loop > For Each Tag**. A For Each Tag step appears in the robot view, and in the browser view a blue box appears around the first article in our loop.

The For Each Tag step has arrows which can be used to iterate through the loop. Use these to iterate through the three articles and confirm that they are selected properly by the blue box. Clicking the arrows will not alter the robot in any way, but they can help us ensure that the loop has the expected iterations. Use the left-most arrow to return to the first article.

The function of the end step now becomes apparent. The loop will loop over every step bounded by the For Each Tag step and the End step. Note that we cannot add any steps after the End step.

Adding a Variable

Now, before we can extract anything we need to add a variable to contain the text we are going to extract. As mentioned in the Introduction tutorial I have already prepared a type called post to use with this robot.

Right click the white box in the variables view in the lower right corner and select **Add Variable of Complex Type > post**. A window opens in which we may configure the variable. Let us keep the default settings and click OK.

A variable of the selected type now appears in the variables view. It contains the two attributes title and preview, which correspond to what we want to extract.

Extracting

Looking at the browser view again we are now ready to make the extractions. Click then right-click the title of the post marked with the blue box and choose **Extract > Extract Text > title**. Extracting within the blue box, called the named tag, ensures that the other iterations of the loop will extract the corresponding titles and previews from the other posts.

Now do the same for the article preview. Click and right-click the preview text and choose **Extract > Extract Text > preview**. Notice that the extracted text is now shown in the variables view. Also notice that two extraction steps have been added and executed in the robot view. Use the arrows on the For Each Tag step, while looking at the variables view, to observe that the text is extracted properly from the other posts as well.

The Return Value Step

To output the collected data we now need to insert a return value step into our robot. Right-click the end step and go to the submenu "Insert Step Before" and choose Action Step. This inserts a new Action Step before the end step.

Use the dropdown in the Step Action View on the right to choose the Return Value action for this step. The Step View now changes to show the properties of the Return Value action. We see that the variable we added earlier has been chosen by default. The robot is now ready to be tested in the debugger.

The Debugger

Switch to Debug mode by clicking the Debug button above the Robot View.

The bottom part of the robot editor is now replaced with panels containing various tools to monitor the execution of the robot. The default tab in the main panel shows Input and Output. Run the robot by choosing Run from the Debug menu. The robot should now successfully execute and the output should be shown in the main panel. We have now successfully built a robot that extracts the three most recent articles from the News Magazine website.

If the execution fails for some reason, you can either redo the tutorial and check all the steps or check the NewsMagazine.robot, which is a robot identical to the one we have just built. The News Magazine robot can be found in the Tutorials folder in the default project.

Next step is to upload the robot to the Management Console and create a Kapplet. Move on to the Management Console tutorial or if you need help on specific topics go to help.kapowsoftware.com.

Kapplet Beginner's Tutorial

[Kapplet Beginner's Tutorial video.](#)

This is the third of four beginner tutorials which will guide you safely through your first project with Kapow. It is advised to watch the overview video and complete the robot tutorial before following this tutorial.

You are about to learn how to use the Management Console and KappZone to run robots as Kapplets. Please feel free to follow along on your computer.

The Management Console is a web-based application for managing the operational aspects of Kapow. First of all, the Management Console acts as a repository for robots and types. It also includes a KappZone which enables you to create and manage Kapplets. Kapplets are robots or collections of robots that have been published as apps, easy to distribute and run.

This tutorial will show you how to upload the News Magazine robot to the Management Console, and publish it as a Kapplet in the KappZone.

Open Design Studio and MyFirstRobot, the robot we created in the Beginner Tutorial on Robots. Then ensure that the robot editor is in Design Mode by clicking the Design Button at the top left corner of the robot editor.

To upload the robot to the Management Console, select Upload to Remote Management Console from the Tools menu. Everything should already be correctly configured so just press Upload. The robot, along with any types associated with it will now be uploaded to the Management Console.

Click the link that appears to the Management Console. This should open your browser in the Repository of the Management Console.

The Repository contains any robots, types and other files uploaded to the Management Console. Observe that the News Magazine robot has been listed. Similarly click the Types tab to check that the associated type has been uploaded correctly.

To create a Kapplet from the robot, go to the KappZone tab at the top of the page. This opens a page with a link to the KappZone. Click it and the KappZone will open in a new window. The KappZone is where you can add, remove and edit Kapplets.

To create a Kapplet click Add New Kapplet at the top of the repository. Call the new Kapplet "News Magazine" and click Create Kapplet. The Kapplet has now been created and we are taken to the configuration page of our new Kapplet.

The new Kapplet is so far disabled, which is indicated by the switch at the top of the page. This means that the Kapplet is only visible to administrators. We will enable the Kapplet as soon as we are done with the configuration.

There are two pages in the configuration of the Kapplet: Identity and Pages, of which Identity is selected. On the identity page it is possible to edit the name, description and icon of the Kapplet. As description I will write "Extracts the most recent news from News Magazine" and for the icon I use the News Magazine logo which I have previously saved to my computer.

Going now to the pages section of the Kapplet Configuration, we need to configure what our Kapplet actually does. Kapplet functionality is structured by pages and even the simplest Kapplet has at least two pages, namely a start page and a result history page.

From the Start Page the user will be able to either start the Kapplet right away or Schedule the Kapplet to start automatically at specific times. Whenever the Kapplet is started, it will run all robots added to the Start Page.

The Result History page archives results returned from the executed robots.

Click Add Action on the start page, then click Add New Robot, choose the robot we uploaded, click Select Robot and click OK.

This adds an action to our Start Page with a button labeled "Start Kapplet". It also automatically adds a new page called Post to our Kapplet. Click the Post page on the left. This page will display a specific result from the Kapplet after it has been chosen by the user from the Result History page.

Right now it displays a table containing the content of the title attribute from each result. Clicking edit on the table we can add the preview attribute to our table and click OK. The Post page will now display both the title and the preview from each of the extracted stories from News Magazine.

Click to apply the changes, enable the Kapplet, and go to the menu on the right. It appears when hovering your mouse over the square in the top right corner. From the menu it is possible to go to My KappZone or just the KappZone. You can think of the KappZone as a repository which holds all the installable Kapplets. My KappZone however, contains only the Kapplets which have been installed to your account.

Click on All under KappZone. We can now see that the News Magazine Kapplet has appeared in the KappZone. Hovering over it, we see that we can either install, edit or delete the Kapplet. Go ahead and install it. Immediately we are able to open the Kapplet. Going to My KappZone through the menu bar on the right, we also see that the News Magazine Kapplet has been added to My KappZone.

Click on the icon to open the Kapplet. The Start Page and the Result History page of our Kapplet are now displayed. From the start page we can either schedule the Kapplet or just run it once by clicking Start Kapplet. Just go ahead and click Start Kapplet.

The first result now appears in the Result History page. Click it to open the Post page showing the result and scroll to the right until the entire Post page with results appears in your browser.

And so, finally our goal has been fulfilled. We have created automated process with a robot and published it as a Kapplet, easy for users to install and use.

The next tutorial will teach you how to create a type in Design Studio.

Type Beginner's Tutorial

[Type Beginner's Tutorial video.](#)

General Introduction

This is the fourth of four beginner tutorials which will guide you through your first project with Kapow. It is advised to complete the other Beginner Tutorials before this tutorial.

You are about to learn how to build a type in Kapow's Design Studio. Please feel free to follow along on your computer.

Introduction to Types

In Kapow, variables are used by robots to store data in. Robots use variables as input, output or to store temporary values during execution. These variables are categorized by types. Examples of types are text, image, PDF, number and so on. The given examples are all what we call simple types. That is, types which are predefined in Design Studio.

Alternately we can create our own Complex Types. Think of a complex type as a bucket of simple types.

Let me explain with an example.

In these beginner tutorials we have been automating the process of extracting and storing the most recent stories from News Magazine. From these three articles we extracted the title and the short piece of text that is given. The title can be held by a variable of the simple type short text and the preview by a variable of the simple type long text. We have to design our complex type to contain each one of these.

Creating a New Type

With Design Studio open, create a new complex type by right-clicking the default project and choosing New>>Type... A window opens, requesting a name for the new type. Since this is our first type we will call it MyFirstType.type. Click finish and the type editor opens. Notice that the type we just created has now been highlighted in the projects view on the left.

Adding Attributes

The most important part of the type editor is the list of attributes associated with our new type. Attributes describe the different values that a variable of our complex type can contain. Each attribute has a name, a type, and a list of other properties associated with it.

Let's start by making the title attribute. Add a new attribute by clicking the plus sign in the lower left corner of the attribute list. A new window opens in which we can configure the new attribute. Name the attribute "title" and select for it the type "Short Text". Short Text is a simple type which can contain text, no longer than one line. Click OK to add the attribute to our complex type.

Likewise add an attribute named preview to contain the short article preview. This attribute should be of the type Long Text which defines a text longer than one line.

What we have now made is a complex type from which we can make variables in a robot. Variables of the type MyFirstType will then be able to hold two values; title and preview. Save the type by choosing save from the file menu.

Changing the robot

MyFirstType.type is now exactly the same as the complex type post.type which we used in the Beginner Tutorial on robots. If we open MyFirstRobot.robot we can now switch the post variable for a variable with the type MyFirstType.

Do this by right clicking the post variable in the variables view and choosing edit variable. In the Edit Variable window that opens, choose MyFirstType as the type for this variable and click OK.

The last step is to save and upload the modified robot to the Management Console. It will automatically take the place of the previously uploaded version.

Congratulations you have now fully completed your first project with Kapow.

Advanced Tutorials

This section contains tutorials on advanced topics of Kapow.

Branches, Robot States, and Execution Flow

This tutorial explains the concepts of [Branches, Robot State, and Execution Flow](#).

This tutorial will explain how and why to use branches in you robots. In the process it will be necessary to introduce the concept Robot States and discuss robot execution flow in general.

If you have completed the beginner tutorials you will know that robot execution starts at the leftmost step and continues sequentially to the end step, where robot execution terminates. This is an example of a linear robot with no Branch Points.

Before showing you the branch point we have to introduce the concept of Robot States. At every step, the robot has various elements which make up its state. The most important elements are the currently open windows and frames and current values of variables, but the state also includes cookies, authentications and so on.

All of these elements make up the robot state.

Back in the robot view we have now introduced a branch point. It's been inserted by selecting Add Branch from the Edit menu in Design Studio.

The robot now sequentially executes each branch from top to bottom. Every time the robot reaches an end step, execution continues from the next branch.

So why go through the trouble of using multiple branches, instead of having a completely linear robot?

Well there are many answers to this question but the most important reason is that the robot reverts to its previous state every time execution goes back to a branch point. As we talked about before, state includes open pages, variable values, and so on, so every time the robot goes back to the branch point, it returns to the page it was on when it passed that branch point and forgets everything that happened in the branch.

Let me show you an example of how to use this.

I'm currently working on a robot which searches the site Momondo for travels to three different destinations but from the same departure city. The robot enters departure city into a form, then splits into three branches and enters three different destinations and clicks to search. Clicking the branch point we enter the state which the robot has when it splits into multiple branches. This is the state which the robot reverts to each time a new branch is executed. This means that the robot does not have to load the site and input the departure city three times, wasting time and CPU power. The robot simply rolls back and continues where it left off, entering a new destination into the form for each branch.

You can use this technique every time one page has to be handled in multiple different ways. We can even join these three branches again since they all use the same steps for the last part of the branch.

To redirect an arrow, first select it by holding Ctrl then clicking on it. Then drag the end of the arrow to the step to which you want to connect it.

You can also create a new arrow by dragging from the right side of one step to the left side of another.

As you may have guessed, you can make some pretty creative robot trees in this fashion, but don't panic! The execution flow is determined by one simple rule and one rule only.

Once execution reaches an end step, execution will continue from the next branch of the most recently reached branch point.

Let me repeat that for you.

Once execution reaches an end step, execution will continue from the next branch of the most recently reached branch point.

Once execution reaches an end step, execution will continue from the next branch of the most recently reached branch point.

It's pretty intuitive once you get the hang of it.

Okay I have a confession. There are other rules which govern execution flow and there is one exception to the rule mentioned before: For Each loops.

For Each loops include the For Each Tag action, the For Each Window action, the For Each URL action, etc.

If you have completed the beginner's tutorials, you have used a For Each Tag loop in your robot, and know how it works. Now we have a new way to think about For Each loops. You can think of a For Each loop step as a branch point where each iteration of the loop corresponds to a branch.

In other words: Once execution reaches an end step, execution will continue from the next branch of the most recently reached branch point or from the next iteration of the most recently reached loop step, whichever comes first.

Loops can be used very effectively in constellation with branches.

There are also other aspects which can make robot execution flow non-linear. One of the most prominent is Error Handling. When an error occurs at a specific step, the error handling of that step decides where the robot will continue execution from. Keep this in mind. To learn more about error handling click the question mark at the top right corner of the Error Handling tab.

So what if I want to keep some information from one branch to the next? Well, let's talk a little bit more about robot states, because not all elements are kept in the robot state. Global variables for example

are totally linear in time throughout execution of the robot and never revert to earlier values when the robot rolls back to former states. This means that you can transfer information among branches or among iterations of a loop.

You can convert any variable to a global variable by checking the checkbox Global when adding the variable to your robot.

Also note that Try Steps look similar to Branch Points but they are not the same. Try Steps are only activated by error handling.

Looping Basics

[Basic looping in your robots video.](#)

This tutorial will give you an introduction to looping within your robots. In particular we will be looking at the types of loops which can be accessed directly from the Browser View.

Looping is both touched upon in the Beginner Tutorial Videos and in the video on Branches, Robot States, and Execution Flow. If you have no experience with looping, I highly recommend you to take a look at these videos before proceeding with this video. Take special notice of the way loops alter the execution flow.

The most useful robots are often those which perform a large quantity of actions, simply those which get a lot done. Often this includes performing the same operations in a number of similar cases. An example is the NewsMagazine robot used in the Beginner Tutorials. This robot uses a For Each Tag step to extract text from several blog posts. The For Each Tag step is just one of many loop steps to which the same logic applies. They all somehow let you perform the same procedure in a number of related situations.

The most basic loop steps are categorized as For Each Tag Loops, because they all somehow loop through tags in the current window. Let me go through these basic loops one at a time.

For Each Tag

The first of three loop steps we are going to discuss in this video is the loop literally called For Each Tag.

For Each Tag loops over each tag of a given name directly within the found tag. The first tag in the loop has been indicated by the blue box in this screenshot of the source view. I now overlay the screenshot with lighter blue boxes to show the following iterations of the loop.

For Each Tag is the loop step which I find myself using most often, simply because of its mixture of flexibility and ease of use. It is also the loop step which we used in the Beginner Tutorial Videos.

Whenever I need to loop over a selection of similar tags, like the products listed on this page, the first thing I try is to right click the first element that I want and select Loop >> For Each Tag. Design Studio then sets up a For Each Tag loop which loops through tags similar to the one I right clicked.

I can now iterate through the loop, using the arrows on the For Each Tag step, to view all the named tags formed by the loop. As discussed in the Beginner Tutorial Videos the blue box formed by a loop is called a named tag and is used as a point of orientation for Tag Finders of following steps, so if we insert a step which extracts the price of the first product, the following prices will be extracted likewise in subsequent iterations of the loop. This is the way all loops, considered in this video, operate.

Sometimes, however, it does cause problems to insert the loop, like here on [vimeo.com](#). I right click the first element that I want and choose the For Each Tag loop, but the resulting loop only includes the topmost listed video. We can see this by trying to go to the next iteration. This results in a window opening to tell us that we have reached the last iteration of the loop.

To fix this I have to go directly to the configuration of the loop step where, in this case, I need to remove the specification of class to loop over. Design Studio guessed that we only wanted tags with the class top but really we want to loop over every listed item, independent of class. I delete the class specification and the loop now works as expected.

To use For Each Tag effectively you should study the different ways to configure the For Each Tag step.

For Each Table Row/Column

For the following loops it should be mentioned that they are often interchangeable and a given situation may be handled in any number of ways. I will try to teach you the basic principles of each loop type so you can be intelligent about which type you choose, but there is no single correct way of doing things.

The two next types of loop steps we will look at are both derivatives of the For Each Tag step, but they have more specific uses. They are called For Each Table Row and For Each Table Column and they respectively loop through rows and columns of a table. As with the For Each Tag step they have been conveniently implemented in the right click menu.

In this screenshot the first row is shown with the named tag marked 1 and the first column is the named tag marked 2. As you can see, combining the two types of loops will let you loop over every element in a table.

To insert a loop over table rows or columns, right click on any table element and select the appropriate action from the Loop submenu. You may either choose to include or exclude the first row or column.

I have now inserted a loop which loops through each column of the newest Ikea furniture. Notice that the name of the loop step is For Each Tag. Instead of having a unique step for looping through tables, the For Each Tag step has just been automatically configured to loop through columns in a table.

For Each Tag Path

The next type of For Each Tag loop is called For Each Tag Path. It is very similar to For Each Tag, which we just discussed.

The difference between the two is that For Each Tag Path loops over tags that are at any level inside the found tag whereas For Each Tag only loops over tags that are directly inside the found tag.

Sometimes the tags you want to loop over are not all directly inside one parent tag, or possibly the tags you want to loop over are all on different levels then you will need to use the For Each Tag Path loop. Notice in this example how the div tags looped over are all within a td and a tr tag and are therefore not directly within the found tag.

The easiest way to determine whether to use For Each Tag or For Each Tag Path is to look at the page structure in the Source View.

For Tags with Class

Just like For Each Table Row and Column were derivatives of the For Each Tag loop as is the For Tags with Class a derivative of the For Each Tag Path loop. As an example of the For Each Tag Path loop let me show you how to use this derived version.

Okay, now let us delete the table column loop we set up and take a look at the For Tags with Class. This loop iterates over all tags with the same value of their class attribute, which is often the case for tags with similar content. This time we have to be a bit more specific which tag we select before right clicking and we also have to keep an eye on the source view.

Usually using this loop goes something like this: As we click on the tags containing each product we look in the source view and notice that they all have the same class, namely productContainer. Once we realize this we can simply right click on one of the tags and choose Loops >> For Tags with Class >> productContainer. We then iterate through the loop to check that the named tags match our expectations.

Again notice that the inserted step is not called For Tags with Class but rather For Each Tag Path, which has simply been configured to perform the specific task.

For Each URL

The last loop we will take a look at is the For Each URL action, which is in a category by itself.

For Each URL simply loops through each URL inside the found tag. It is often useful if you need to extract or click on every link in a specific area of a page, regardless of the context of the link.

For Each URL is most easily inserted by selecting the tag containing the links you would like to loop over, then right clicking the selection and choosing Loop >> For Each URL.

I have now set up a loop which iterates through each URL in this article. It by default skips duplicate URLs.

Let's leave the For Each URL action at that. Just note that For Each URL has a number of configuration possibilities which can be changed in the step view.

Finally I have two notes that will help you when using loops.

Note 1

Just to spell out what I said in the video on Branches, Robot States, and Execution Flow: A For Each loop step, like any of those in this video, executes every subsequent step in the robot view for every iteration of the loop, so if you want your robot to continue execution beyond the loop, then you will have to insert a separate branch before the loop step. This branch will then be executed after the loop has finished.

Note 2

It is often nice to be able to break a loop or skip an iteration based on certain conditions. If we for example reach an iteration where one of the steps within the loop cannot be performed, it would often be logical to skip this iteration altogether.

As mentioned in the video on Branches, Robot States, and Execution Flow this can be done by adjusting the Error Handling of the step that fails. In the Step Error Handling View you can choose Next Iteration or Break Loop if an error occurs at this step.

At default this option is set to Skip Following Steps which corresponds to letting the robot hit an end step at its current execution position. In other words, if an error occurs at this step, the robot will go back and execute the next branch of the most recently reached branch point or the next iteration of the most

recently reached loop step, however it will also cause an API Exception and Log an Error as indicated by the check boxes.

These were just the basics of looping. To learn more check out the Loops in Forms and Repeat-Next Loop videos. Also feel free to go to help.kapowsoftware.com to read about loops in greater detail.

Loops in Forms

[A video demo of the loop steps which apply to forms.](#)

This tutorial will give insight into types of loops which are useful when working with forms. It is a direct continuation of the Looping Basics video, and will extend on the knowledge obtained there.

Many of the loops discussed in this video will have a form similar to the For Each Tag loops from the Looping Basics video but the form loops are all different from the For Each Tag loops in that they don't assign Named Tags for each iteration, instead they perform some other action for each element they work on.

For Each Loops in Forms

There are two For Each Loops and one other loop specifically designed to be used with forms. They are called For Each Radio Button, For Each Option and Loop Field Values.

I will be demonstrating each of the Form Loops on this library search page.

For Each Radio Button does what you would expect; it selects one radio button in a group for each iteration. The easiest way to insert the step is to right click a radio button and select For Each Radio Button in the Loop submenu. Iterating through the loop we see that each radio button is selected sequentially.

The next form specific loop is called For Each Option. It loops through options in a drop down list. Again it is easily selected from the right click menu. Once selected; a window appears asking whether you would like to skip any of the options of the drop down. This is useful for skipping any options that are not appropriate for what you want to do. In this case I will loop through all the options. Each option is now selected when clicking the arrows on the loop step.

The last loop I want to discuss in relation to forms is called Loop Field Values . This is not a For Each loop, which means that it is used slightly differently from the other loops I have described. It can be used on any text input field to loop through listed values that are then inserted into the field. One value for each iteration of the loop. Again we simply right click and select the Loop Field Values option. We can now choose which types of values to loop through. We can either choose one of the predefined options or we can compile our own list of values that we would like the robot to input. Since we are searching a library I will compile my own list consisting of Hemingway, Shakespeare, and Poe. Iterating through the loop we now observe that the stated authors are entered in to the text input field.

That concludes this video on Loops in Forms. To learn more go to help.kapowsoftware.com.

Repeat-Next

[Click to open a video demo introducing the Repeat-Next loop.](#)

This tutorial will give insight into an advanced but very useful loop called a Repeat-Next loop, which works particularly well for looping through pages where each page leads to the next.

We will build upon the skills learned in the Looping Basics video, so make sure to watch that first.

Repeat-Next

This loop type is the oddball in the looping family, or maybe you could argue that it is not even part of the family because the way this loop is designed is totally different from all the other loop steps in Design Studio.

First of all the Repeat Next loop consists of two individual steps which need to be used collaboratively to have any kind of effect.

The concept is actually pretty simple: you place a Repeat step followed at some point by a Next step. When execution reaches the Next step, execution will revert back to the Repeat step and proceed execution from there, marking one iteration of the loop. If a Next step is not reached after the Repeat step then the loop will terminate.

The catch here, and also what makes the Repeat-Next loop so genius, is that while most of the robot state is reverted at the beginning of each iteration, the page reached at the Next step is actually transferred to the next iteration of the loop. So unlike the other loops we have looked at where the entire robot state is reverted at the beginning of each iteration, we can handle a different page in each iteration of the Repeat-Next loop.

Demo

A typical example of using the Repeat Next loop is when looping through multiple pages of search results. We insert a Repeat step ... followed by a step which clicks to get to the next page ... and then a Next step ... It's as simple as that to loop through all the pages. We can now use the arrows on the Repeat step to iterate through the loop and observe that a new page is loaded for every iteration.

Of course we still need a way to terminate the loop. This can be done by setting the error handling of the Click step to "break loop". If the click step does not find a link to the next page, we assume that we must have reached the last page and the loop breaks.

If we then want to perform some steps on each page, we can add a branch step after the Repeat step ... and add a new top branch. In this new branch we can add loops and other steps without them being influenced by the Click and Next actions in the other branch. I can for example add a loop over all the search results on each page ... extract information from each result ... and return that collected information. In total I get a robot which extracts every result from every page of the search. We can get an idea about the execution flow by single-stepping through the robot in Debug Mode. I have sped up the recording so you can clearly see how all search results are extracted, one page at a time.

Remember the form in which the Repeat-Next loop is used here. A top branch which executes the steps you want to perform on each page and a lower branch which loads the next page and calls the next iteration of the loop. This constellation is useful and very common when using this type of loop.

Note that setting the error handling of a step to "Next Iteration" does not work with Repeat-Next loops. In order to proceed to the next iteration, a Next step must have been executed.

Try Step

[Click to see a video explaining how to use the try step to set up conditions and error handling in your robots.](#)

This video will demonstrate how to use try steps when building robots in Design Studio. Applications of the try step are crucial for building robust robots acting on a dynamic web environment where changes in structure are commonplace. Use cases include trying multiple different strategies for interacting with or extracting from a website, and setting up conditional statements in a robot. We will go through two examples in this video, demonstrating the two use cases, starting with the latter.

As a first example we'll be using `ExtractFromTable.robot`, which is a basic robot that extracts data from a table on the News Magazine website. It can be found under Robots in the Examples folder of the default project. I open the robot and hide the projects view.

Once open, you will notice that the robot has only one path to follow in the robot view until it reaches this diamond shaped step called a try step. What a try step does is set up multiple alternatives for the robot to try. A try step can have any number of alternatives which are shown as dashed arrows emerging from the right side of the try step. If an alternative succeeds the robot continues as usual, ignoring any other alternatives from that try step. If an alternative does not succeed, however, the robot goes back to the try step and tries the next alternative.

To use try steps it is therefore important to understand what it means for an alternative to "succeed" or "not succeed"? Let me try to demonstrate with this example robot.

`ExtractFromTable` is a simple robot that extracts person information from a table by using a loop. Clicking the "for each tag" step and scrolling down reveals the table which the robot extracts from. Inside the loop, which loops through the rows in the table, the four pieces of information for each person are assigned to different attributes of the person variable. The try step is used to assign either true or false to the `isMale` attribute, based on the value of the last column in the table, called `sex`. The column can have either one of two values, "Male" or "Female" and we want to assign true or false to the `isMale` attribute respectively.

To test the value in the `sex` column, a `Test Tag` step has been inserted in the first alternative. `Test Tag` is a step which can conduct an action based on whether the found tag matches a specified pattern. Clicking the `Test Tag` step we see that the found tag is the cell in the `sex` column of the row from which we are extracting in the current iteration, and the pattern to match is simply set to "male" and only matches against text, ignoring case. If the pattern matches, the step then does what is specified in the `Error Handling` Tab. Under `Error Handling` the step has been set to "Try Next Alternative", which is also indicated by the small icon in the upper left corner of the step. This means that if the `sex` is male, and the pattern is thereby matched, the `Test Tag` step will do what is specified under `Error Handling` and try the next alternative. The second alternative therefore, has a step that assigns "true" to the `isMale` attribute. If the pattern is however not matched, the `Test Tag` step does nothing and execution proceeds normally to the next step, which assigns false to the `isMale` attribute.

In other words, an alternative can be said to succeed if no errors which specify to try next alternative are encountered, and can be said to not succeed if such an error is encountered. As soon as one alternative succeeds, all other alternatives are skipped.

In the example I just went through, the error was generated by the `Test Tag` step, but usually errors are caused by steps which are unable to perform their actions. This is most often because steps cannot

find a certain tag or loading of certain content times out, but it could be anything that stops a step from performing its action.

Executing the example robot in debug mode you will see that the correct values are assigned to the `isMale` attribute. True values are indicated by check marks and false values are indicated by the absence thereof.

To give you an even better understanding of how the try step works, let me show a more complex, yet common, use case. In Design Studio I have this robot which needs to log into a site and extract some data, which is only available upon login. The page used by the robot is of course the familiar News Magazine page. The robot is called Login and is available from the examples folder. If you have closed the Projects View, it can be reopened from the Window menu.

Look at the robot view to get an overview: In the login process, the robot uses save and restore session in such a manner that the robot logs into the site and saves the session on the first run. Consecutive runs will then load the saved session instead of performing the login sequence again. At some point the session expires and the robot will have to log in and save a new session. Most robot executions will thus be able to restore a session and be able to skip the entire login procedure.

So... we have three different scenarios to test for: either it is the first time the robot executes and there is no saved session, or there is a saved session which is already logged in, or there is a saved session but it has expired.

Looking at the robot view, there are two alternative paths for the robot to take, depending on whether it is able to use the stored session or not. To show each case, let's try simulating them by clicking through the robot.

The first time the robot is executed there is no saved session. The robot will first try the topmost alternative from the try step, but if I try executing the Restore Session step it will fail, since there is no session to restore. When this step fails, it will cause an error, triggering error handling which is set to "Try Next Alternative". The robot will therefore have to execute the second alternative, which follows this lowermost branch, loading News Magazine, clicking to get to the login page, entering username and password, clicking to login, saving the session for future executions of the robot, clicking again to get to the data we want to extract, and finally extracting the specific text. We have now simulated the first run of the robot.

Going back to the first step in the robot, let's simulate the second run. In all executions following the first, the session should restore successfully, so following the topmost alternative the session is restored, the robot clicks to open the page that we want to extract data from, and finally the data is extracted - simple.

We now want to replicate what happens if the robot is to execute after the login session has expired. To do this, open Logout.robot from the examples folder. The logout robot restores the saved session and clicks logout on the News Magazine page. In this way we are emulating expiration of the login session, rather than actually waiting the 10 minutes it takes for the session to timeout and expire on this specific page. Click the end step in the logout robot to execute all steps.

Going back to the login robot click the step named "Click site data" to make it the active step and click refresh in the toolbar to re-execute all steps up until the active step. After all the steps have executed again, notice that the page shown in the browser view looks as though we are still logged into News Magazine. This is because the saved session also contains the entire robot state, including the html of the page we were on when the session was saved. Restoring the session therefore does not properly refresh the page to show us its current state. Clicking on the extract step to execute the click step will however refresh the browser to show us that we are no longer logged in. The extract step therefore fails to extract

the data we want, causes an error and tries the next alternative from the try step, which logs in and saves a new session for future use.

Thus the login robot handles all three cases and thereby ensures that the robot always logs in before extracting the data which is otherwise not available.

To summarize on what we have looked at in this video, from a try step spring multiple alternative routes for the robot to take. An alternative succeeds unless it has a step that causes an error and specifies to "Try Next Alternative" in the Error Handling Tab. Only the first alternative that succeeds is executed, the others are completely ignored. If an alternative does not succeed, the robot goes back and tries the next alternative.

Here are a couple of tips when using try steps:

As we saw in the first example, any condition steps, meaning steps with "Test" in their names, work well together with the try step.

If no alternatives of a try step succeed then the try step itself generates an error. Specify what action to take in the error handling tab of the try step itself.

You can give a try step a name by double clicking below it in the robot view.

When specifying to "try next alternative" under error handling for any step, you can also choose which try step to go back to based on their names. This means you can have nested try steps allowing for complex robot structures.

That concludes this video on the topic of try steps.

Excel

[Click to watch a video explaining how to read data from Excel documents.](#)

Starting from Kapow version 9.2, robots have a whole new way of handling Excel documents. Instead of being converted into html-pages, Excel is now shown as a spreadsheet directly in the Page View in Design Studio. In this video we will give an overview of the features of the Spreadsheet View and take you through the process of building a robot which extracts from an Excel document. Feel free to follow along on your own machine.

An example of a robot which loads an Excel document can be found in the examples folder of the default project, and has the name excel.robot.

Go ahead and open the robot. Excel documents can be loaded in the same way as regular pages are loaded, either from a URL or from a file on your machine or server. In this particular robot it is loaded by clicking a link, which is performed by the step named Click PersonData.xlsx.

Click the Loop Rows step to view the document. The spreadsheet now appears in the page view, with rows and columns named and arranged like you are used to it from Excel. This particular document contains tables with person data.

There are two different sheets with 100 entries in each. It is possible to switch between the two sheets in the lower left corner of the Page View. It is also possible to see the document information by clicking the leftmost tab. In this video however, I will focus on Sheet1.

From the drop down menu in the lower right corner of the page view it is possible to look at the unformatted values of the document or the raw formulas. Changing this view will also affect the extracted values when inserting a new step, so I am going to change it back to showing formatted values.

A cell is selected by clicking on it and it is even possible to select a range of cells by clicking and dragging, or clicking on a row or column name to select the entire row or column. The upper left corner selects the entire spreadsheet.

I will now delete the loop step and all the extract steps from the robot and demonstrate how easy it is to extract from an Excel document. I drag to select the steps, then hit the delete button on my keyboard.

To the new Spreadsheet View belongs a whole family of new step actions, which enable you to loop, extract, and test cells. Just like in the browser view these functions are available from the right click menu as I will show you in a moment.

First we want to insert a loop step which loops through all the rows of the table. First I click the upper left corner of the Spreadsheet View to select the entire spreadsheet. Then I right click inside the selected area - meaning anywhere inside the Spreadsheet View- and select Loop>>Loop Table Row>>Exclude First Row. I am excluding the first row since we are not interested in the header values.

The Loop in Excel step now sets the first row to loop over as the Named Range. Clicking the arrows on the loop step will show how the other rows are selected. It is now possible to extract from the Named Range and, because of the loop, corresponding values will then be extracted from all the other rows.

To extract first the ID, I right click the ID value and select **Extract > Extract Number > ID**. I click OK in the wizard that appears, which is already properly configured.

Likewise I can now extract the first name as a text into the name variable, the age as a number into the age variable and the gender as a Boolean into the isMale variable. The gender value is either true for male or false for female.

To show that the entire table can now be extracted, I switch to debug mode by clicking the icon in the upper left corner and clicking run in the toolbar. All 100 values from the Excel document now appear in the list of results.

Writing to Excel

[Click to watch a video tutorial on how to write to an Excel document.](#)

This tutorial video will show you how to make a robot that automatically creates an excel document based on data extracted from a website. Please feel free to pause the video along the way so you can follow the steps on your own computer.

With Design Studio open, we go into the Examples folder in the default project. Under Robots, we find and open the example robot called TableExtract.robot. This is a robot which extracts person data from a table on the website News Magazine. We can see the table by clicking on the loop step.

Before moving on, make sure you familiarize yourself with this robot. We will modify the robot to write the extracted data into excel.

We first need to clean up the robot a bit. We start by deleting the two first steps, which are only there to display help about the original robot.

Then we add a new type to the robot by right clicking in the Variables view and choosing Add Variable of **Complex Type > PersonListExcel**. This type contains an Excel attribute, which the robot will write to. Let's call the variable personList and mark it as Global. Having a global variable ensures that we can add content to the spread sheet over multiple iterations of a loop in our robot. We click OK.

To modify our Excel variable, we must open it in the page view. We right click personList and choose Insert Step >> Open Variable >> personList.list. This inserts and executes an Open Variable step in the Robot View and, although the sheet empty, we can now see the content of our personList variable.

Next, we add a header for each column in the table we are extracting from. To insert content into Excel, we right click a cell and choose Modify >> Set >> Text. This opens a dialog where we can specify the value to insert. We write "id" and click OK.

Then we repeat this process for the next three cells which we call "name", "age" and "isMale". It's now time to make the robot insert the extracted data into this spread sheet. We click on the end step of the robot. An error might occur, stating that the Test Tag step stopped execution. This is an intended error. To get around it, use the lower alternative from the Try Step.

We switch to the Excel window by right clicking it and choosing Set as Current Window. This inserts and executes a Set Current Window step in the Robot View.

Before we can insert new content into the Excel variable, we must extend the sheet with a new row. We select the entire sheet by clicking the upper left corner of the Excel View. Then we can right click on the sheet and choose **Modify > Insert > Rows > Last**. A dialog opens, asking how many rows to insert. We only need to insert one row for each iteration so we press OK. This will insert a new row as the last row in our sheet and mark it as a named range.

We can now select the named range by clicking the second row on the very left side of the Excel View. We then right click the selected row and choose **Modify > Set > Content of Row > person** to insert the data extracted from News Magazine.

Stepping through the iterations of the loop, we can see how multiple rows of content are added to our Excel variable.

So now we have a robot which creates and writes to an Excel variable. To get full usage of our robot, we need to make it save the Excel variable as a document on the hard drive. To this extent, we insert a branch just before our loop step. The lower branch will be executed after the loop has finished all iterations.

Stepping into the lower branch, we add a new action step and select for it the Write File action, which can be found under the File System category.

To configure the Write File step, we need to give a file path. I will simply place the file at the root of my C: \ drive and call it simpleExcel.xlsx. You may choose to place it wherever you want. The file content should be our personList variable.

Running the robot in Debug Mode will now write the Excel variable as a document at the specified location. If we open the file, we see that our spread sheet looks as expected.

This was a very simple example of how to write to excel in a robot. For a more advanced example take a look at ExcelAdvanced.robot in the examples folder or read about the capabilities of writing to excel in the documentation in Kapow help.

Data Conversion

[Click to watch a video describing how to perform data conversion in robots.](#)

Sometimes when designing a robot we need to convert some text or numbers using simple or complex conversion rules. The question is: how do we do this easily in Design Studio?

In this video we will be talking about this field.

It may not look like much but it is actually a very powerful tool when building robots and it pops up everywhere in the Design Studio interface.

The field is called a Data Converter List, and for now let's regard it as a black box. It may take an input in the form of a value from, for example, a variable or extracted text; but input is not a strict necessity. The input, if present, is given by the placement of the Data Converter List and is always stated somewhere above it.

The Data Converter List has exactly one output, which is either stored in a variable or handled otherwise below.

In short, a Data Converter List is used to manipulate text and numbers within robots, but although it is possible to perform both text and number manipulation with the Data Converter List, input and output is strictly speaking always interpreted as text.

Some use examples include extracting the name from an email address,...

..multiplying a number by two,...

or adding three days and two hours to a given date.

Let's take a look at the interior.

As the name Data Converter List implies, the field contains a list which you can add a variety of different converters to by clicking the plus icon. These converters all manipulate the input in some way.

Here is an example where we have the Kapow Software website URL as the input. We start with no converters in the converter list so the output is the same as the input. By adding the Extract converter we can extract the middle part of the URL. Don't worry about how the converters work for now. We will get back to that.

Then we can add a converter which converts the text to upper case.

The two converters are then chained together in series so the output of the first flows into the input of the second.

The order in which the converters are listed represents the order in which they are performed. The order can be changed by clicking the arrows. In this case it makes no difference to the end result.

Converters can be deleted by clicking the minus.

Clicking the pen and paper icon opens a window used to configure the converter. This window also opens when the converter is first added to the list.

The Converter configuration window always contains the two important fields Test Input and Test Output which, as the names imply, demonstrate the input and output from the given converter.

Learn how to use the different converters by clicking the question mark in the configuration window. Clicking it opens the documentation. Here you can also read about Expressions and Patterns. Knowing how to use these is an invaluable skill when working with data converters.

For example if you need to use mathematical operations to manipulate a number, expressions are needed. I can multiply the input by two by using the converter called evaluate expression. Let's take a closer look at the expression used to perform this operation. It converts the input to a number and then multiplies it by two. Remember that all input and output from converters is text so we need to convert the input to a number before applying any mathematical operations to it.

Here are some examples of the use of data converter lists in Design Studio.

The data converter list you will find the most useful is probably the one located in the Extract step action. It allows you to convert any extracted text before storing it in a variable.

Let me show you an example of how to use this.

I'm in the process of creating a robot which extracts job offerings from LinkedIn. For now it simply loads the page and loops through the tags which contain job descriptions. I would like to extract the location of each job but it's stated in the same tag as two other pieces of information, namely company name and date. The three pieces of information are only separated by hyphens.

I start by extracting the entire text into a variable called location. I then select the Extraction step in the robot view and add an extract converter to the data converter list of the extraction step. The extract converter uses a pattern to decide which part of the input should be extracted and used as output. In this case we want to extract everything within the first and the second hyphen.

After finishing the pattern we can see that the Test Output field reflects the text we wanted to extract.

Selecting the end step and iterating through the loop we can see that the location has successfully been extracted from each of the job descriptions.

As you can see, converters are quickly implemented and extremely effective.

Lastly I'll give you a couple of tips on the use of data converters.

Tip 1: Many fields in Design Studio can be changed to data converter lists. This may be done by choosing Converters from the Value Selector located at the right side of the field.

Tip 2: One of the most useful converters is the Replace Pattern converter. It combines expressions and patterns to provide powerful text manipulation.

Tip 3: In addition to the restricted one input of data converter lists, additional variables can be fetched by using expressions. This allows us to combine data from several variables.

Thank you for watching this short introduction to data converters.

For more information on the available converters, see [Data Converters](#) in the Reference section.

Patterns

[Click to watch a video on patterns and their use in Design Studio.](#) The first half is a lecture like presentation of the syntax, the second half looks closer at some use-case examples in Design Studio. Answers to the problems given in the video can be found at the bottom of the page.

Hello. This video will take a closer look at regular expressions, called patterns in Kapow. The first half of the video will be a lecture-like presentation of the syntax including wild cards, sets, subpatterns, repetition operators, alternate subpatterns, and subpattern references. The second half will go through three examples in Design Studio using patterns to create conditions and tag finders and to perform data conversion. If you're already familiar with regular expressions you might want to skip directly to the examples.

As mentioned earlier, regular expressions are called patterns in Kapow, and will be referred to as patterns for the remainder of this video.

The Wild Card

A pattern is a way to put a string of characters into more general terms by using symbols to represent strings of characters. You might be familiar with the concept from doing searches on your computer where it is sometimes possible to use wild card symbols to represent any character. Doing a search for 'ca*' (the asterisk being the wild card in this example) might return both "cap", "car", "can", and so on. Patterns embrace this same concept while expanding to a much more extensive syntax, which will be presented here.

Kapow uses the Perl5 syntax for its patterns. In this syntax the wild card character is symbolized with '.' (a dot or period) which corresponds to any single character including all symbols, whitespaces, and any other special characters you could think of. This correspondence is called matching so the pattern 'ca.' is for example said to match "cap", "car", "can", or any other string of "c" followed by "a" followed by any single character. Similarly the pattern '.a.' matches "nap", "tan", "sad", or any other string of three characters with an "a" as the middle character. It does however not match "an" since each '.' in the pattern has to match up against exactly one character. Similarly it does not match "cans" since the pattern has to match the entire string, not just part of it.

We can test whether a pattern matches a given string directly in Design Studio by using the Pattern Editor. The Pattern Editor can for example be found by inserting a Test Tag step into a robot and clicking "Edit..." below the pattern field in the step action view. The Pattern Editor has three sections. At the top it is possible to type in a pattern, which is then matched to the string typed into the Input field on the left. Clicking the Test button or using the shortcut Ctrl+Enter will tell you whether the pattern matches the input.

Try typing '.a.' in the Pattern field and "can" in the Input field. Then use the shortcut Ctrl+Enter. The Output field will now display "The pattern matches the input." We can ignore the rest of the output for now. If we on the other hand type just "an" in the input field and press Ctrl+Enter we receive the message that "The pattern does not match the input." As I go over more of the pattern syntax, try to experiment with the Pattern Editor to test your understanding of the material.

Although not stated explicitly we are now able to match in two different ways, either we can match character to character (ie. The pattern 'a' matches the string "a") or we can use the wild card symbol '.' to match any character. Additional direct character matching includes the ones listed in the table here.

Pattern	Matches the string
'\n'	A line break character.

Pattern	Matches the string
'\r'	A carriage return character.
'\t'	A tab character.
'.'	"."
'\\'	"\"

Any other symbol used by the pattern syntax can also be explicitly matched by preceding it by a backslash '\.

Sets

Next step is to match a semi known character. By semi known I mean that we only want to match the character with one character in a set of characters. A set of characters is stated in a pattern by using '[]' (brackets). An example is '[abc]' (the set of a, b, c) which will match to either "a", "b" or "c" but will not match to any other characters than these three.

If you wish to include a range of characters to a set it can be done using a '-' (dash or hyphen). '[abc]' can therefore be written as '[a-c]' (the set of characters: a through c). Using words '[a-c]' means match any character in the range from "a" to "c". The two ways of defining sets can be combined to get something like '[a-dkx-z]' (the set of a through d, k, and x through z) which is similar to writing '[abcdkxyz]' (out all those characters in a set) or saying match any character which is either in the range "a" to "d", is "k", or is in the range "x" to "z".

It is also possible to define sets negatively by using '[^]' (a caret at the beginning of the set). An example is '[^a-c]' (the negative set of a through c) which will match any one character excluding "a", "b", and "c".

In the Pattern Editor, try using sets to match (1) any digit (2) any whitespace character (3) anything that is not a digit. You can pause the video if you want to take a moment to think about these problems before seeing the answers (the answers are all given at the bottom of this page).

There are certain shortcuts which can be used for sets that are often used. Here is a table showing some of the most important ones.

Shorthand form	Set
'\d'	'[0-9]' (Any digit)
'\D'	'[^0-9]' (Any non-digit)
'\s'	'[\n\r\t]' (Any whitespace character)
'\S'	'[^ \n\r\t]' (Any non-whitespace character)
'\w'	'[a-zA-Z0-9_]' (Any word character)
'\W'	'[^a-zA-Z0-9_]' (Any non-word character)

Note The shorthand form can also be used inside sets. For example '[d\w]' includes all digit and whitespace characters.

Subpatterns

Next we will need to talk about subpatterns within patterns. Terms we have talked about so far such as a character 'a', a set '[abc]', an escaped character '\d' or the wildcard '.' can each be seen as a subpattern. Alternatively we can create our own subpatterns by grouping together other subpatterns using '()'. We could for example create a subpattern from '[ctb]an' by writing '([ctb]an)'. We could for example create a subpattern from '[ctb]an' by writing '([ctb]an)'. We could for example create a subpattern from '[ctb]an' by writing '([ctb]an)'. We could for example create a subpattern from '[ctb]an' by writing '([ctb]an)'.

It is important to recognize these since I will now be introducing some operators which work on the entire subpattern they follow.

Repetition Operators

Operators in patterns allow us to match repetitions of a subpattern by following them with one of the operators given in the table.

Repetition Operator	Meaning
'{m,n}' where $n \geq m$	Matches between m and n repetitions (inclusively) of the preceding subpattern.
'{m,}'	Matches m or more repetitions of the preceding subpattern.

For example, the pattern 'a{1,}' would match the string "a", "aa", "aaa", or any number of repetitions of 'a'. The pattern '([bn]a){3,3}' would match 'banana', 'babana', 'nabana', or any other string of either "b" or "n" followed by "a" repeated three times. Try it out for yourself.

As for the sets, there are also shorthand versions of the most useful repetition operators as shown in this table.

Shorthand operator	Corresponds to
'{m}'	'{m,m}'
'?'	'{0,1}'
'*'	'{0,}'
'+'	'{1,}'

Try using what we have learned so far to match (4) anything (5) either "color" spelled without a "u" or "colour" spelled with a "u" (6) any four digit number. The answers follow (at the bottom of the page).

One of the often used patterns is '.' which matches anything: any string even if it's empty.

Now try extending this and find patterns that match (7) any text containing at least one digit (8) any text containing just one digit. Here is a list of the syntax you may need (video only).

The syntax used in the answers is very useful when matching specific subpatterns within a string.

Alternative Subpatterns

We discussed how to match alternative characters earlier, but what about matching alternative subpatterns? If we have N subpatterns 'p1' through 'pN', we can match any one of these subpatterns using '(p1|p2|...|pN)' (parentheses and vertical bars as shown here). The pattern given here '(abc|a{5})\d' would for example match with either "abc", "aaaaa" or any number.

Try using alternative subpatterns to make a pattern that matches (9) a string which does not contain just one digit. Here, again, is the syntax you might need. And here is the answer: (page bottom)

There is no not operator in the syntax, instead the answer uses two alternatives. The first alternative matches a string with no digits, the second matches any string containing at least two digits.

Subpattern References

The last major part of the syntax to cover is subpattern references. Any substring, "s1" through "sN", matched by a parenthesized subpattern, '(p1)' through '(pN)' in any one pattern, can be referenced to by using '\1' through '\N' where each subpattern is numbered in order from left to right as they are stated in

the pattern. Matching '([chm])(at)' to "cat" for example, we could use the reference '\1' to refer to "c" and '\2' to refer to "at".

The entire pattern can always be matched by '\0'.

Notice here that we are referring to the string matched by that subpattern rather than the subpattern itself. A reference to the subpattern '(abc)' would of course yield 'abc' whereas a reference to the subpattern '(d)' would only match whatever digit was matched by the original subpattern.

As an example consider matching a string containing a quote by using the pattern '.*(["']).*\1.*' (anything followed by a single or double quote followed by anything followed by a reference followed by anything). This may look confusing but the only thing you really need to notice is that the reference will match the same type of quote which was matched by the subpattern. In other words, this pattern would match both the string He said "hello" with double quotes and He said 'hello' with single quotes. I have purposefully not quoted the two strings here to avoid confusion.

As I will show you later in Design Studio, subpatterns can also be referred to in certain expressions outside of patterns. This is useful when extracting certain parts of a matched string. Taking our quotes example we could add parentheses around the subpattern enclosed by quotes '.*(["'])(.*)\1.*'. Now we are able to extract the quote in Design Studio.

Here is another problem. Try using subpattern references to match (10) four of the same digit (11) a string where at least two characters are the same. ... The answers are given (at the bottom of the page) here.

Fewer Repetitions

When using subpattern references it is handy to know the following. By default, the repetition pattern operators (*, +, {...}) will match as many repetitions of the preceding pattern as possible. You can put a "?" after a repetition operator to instead make it match as few repetitions as possible.

(12) Try matching a subpattern to the first occurrence of a digit in a string. ... the answer is given (at the bottom of the page) here.

Removing '?' would result in matching the subpattern to the last occurrence of a digit in the string.

Using Patterns in Design Studio

Now that we have learned the syntax of patterns it is time to look at the various use-cases in Design Studio.

Conditions

Creating conditions is the first way of using patterns intelligently in robots. The Test Tag step action is particularly relevant in this context so let's go over a common use case.

I here have a robot which extracts from LinkedIn, all engineering jobs they have listed for Denmark. The robot uses a loop to extract the URL, title, and company name from each job and return them to the user. But let's say I only want to extract from jobs which contain the words "Copenhagen" and "software", indicating that they are probably looking for software engineers in Copenhagen.

First, I insert a new step after the For Each step and assign to it the Test Tag action by clicking on the new step to select it and choose Test Tag from the drop down in the step action view. I ensure that the tag finder finds the entire job post of the current iteration of the loop. Then I iterate through the loop until I find a job offering which matches the criteria I am about to set. This makes it easier to test that the pattern I write will actually work.

Going to the action tab in the step view, I first choose to match only against text (not the entire HTML), then press edit on the pattern. I am now in the Pattern Editor and I can type a pattern to be matched. Since I do not know the order in which the two words "software" and "Copenhagen" might occur, I need to make two alternative subpatterns. In the first alternative I can have Copenhagen followed by anything followed by software. In the second alternative I write the same but in reverse order. Finally I add

"any text" before and after the alternatives and press Ctrl+Enter to test whether the pattern matches. It matches!

I close the Pattern Editor and set the Test Tag step to Skip the Following Steps if the Pattern Does Not Match the Found Tag. This way the job post will be skipped if it does not contain the two words specified.

I now go ahead and run the robot in Debug Mode. As expected only few results are extracted and they should all contain the words Software and Copenhagen.

Tag Finders

Patterns can also be used in tag finders. This can be very useful if you know the structure of the information you are looking for but you do not know where on the page it is located. This robot for example goes to multiple different sites to extract the price of a certain pair of headphones. Since we cannot know where on the page to find the price, patterns play a crucial part in determining exactly this.

Let me show you how to set up the extraction step. I'll delete the one I already have, insert a new step and choose for it the Extract action. To configure the step I start by inserting a number converter which extracts the number from any text I might extract. Then I choose to extract into the price attribute of the variable I have made for this robot.

Going to the Finders tab in the step view, I click plus to add a Tag Finder. I locate the price on the page. I can see that it is secluded in its own tag, with nothing else in that tag. This is typical so we will let our pattern match this case. In the Finders View there is a field called Tag Pattern. Immediately we can write the pattern `\"$[d\\.]+\"` (dollar sign followed by one or more digits or dots). The pattern is designed to match any tag containing only a dollar sign followed by a decimal number. I click the magnifying glass in the upper right corner of the page view, which shows me what the Tag Finder finds. Unfortunately it finds the cart balance instead of the headphone price. The cart balance will always be \$0 for these kinds of sites, so to avoid this mistake, I will make sure that the first digit in my tag is not a zero. Fortunately, the steep price of headphones ensures that the price will never start with a zero. Rewriting the pattern I get `\"$[1-9][d\\.]+\"` (dollar sign followed by a digit which is not a zero followed by one or more digits or dots) which finds the correct price on the page when I click the magnifying glass.

Before testing the robot I go to the error handling tab of the Extract step and choose to Ignore and Continue on error. If the Tag Finder fails to find the price on the page it should just return the default value of the price attribute which is set to -1. This gives me a clear indication that the robot was not able to find the price. Going to Debug Mode and Looking at the results from an earlier execution of this robot, we see that many of the prices are extracted correctly. The method is of course flawed but it can be surprisingly effective at times.

Data Conversion

The final use for patterns is to convert data from one form into another... For this we can either use one of the data converter lists embedded in a step or use the dedicated Convert Variables step.

In this very simple example, I am extracting the author and date from a blog post. Unfortunately, the two pieces of information are contained by the same string of text and are therefore extracted collectively by the extract step. I will now show you how to separate these two pieces of information using patterns in data converters.

The extract step has a data converter list located in the step action view. The data converter list can be used to convert the extracted text before it is assigned to a variable. I click the plus and choose Extract to insert a data converter which can extract part of the string. A new window opens where I can configure the Extract data converter. At the top there is a pattern, and at the bottom there is a test input and a test output similar to those of the Pattern Editor. The idea with the Extract converter is to write a pattern which matches the entire input string, and then specify the subpattern to be extracted by using parentheses. By default, the entire string is matched AND extracted, resulting in identical input and output strings.

If I want to exclude something from the extracted string I just have to write it outside of the subpattern. Let me precede the subpattern with `.*` by `'` (any text followed by "space", b, y, "space"). Now the entire string is still matched, but only the name of the author will be part of the substring, and therefore the authors name will be extracted as shown in the Test Output field. The plain text `'` by `'` forces the two instances of `.*` (any text) to match the date and the author name respectively.

I can now close the configuration window and execute the extract step. The author name is now correctly assigned to my variable.

Let me go back to the extract step and quickly demonstrate another converter which uses patterns. I remove Extract and add the Advanced Extract converter instead. Then I write the same pattern as I used before except that I make subpatterns out of both instances of `.*` (any text). The Test Output is now still the same as the Test Input. This is because Advanced Extract enables me to choose which subpattern I would like to extract by using subpattern references in the Output Expression field.

In expressions, subpattern references are made using the `'$'` symbol followed by the reference number. Right now the expression refers to the entire matched pattern but if I change it to `'$1'` I only get the first subpattern, extracting the date, and if I write `'$2'` I only get the author name which is matched by the second subpattern.

Note that it is also possible to add text, combine subpatterns, and do simple string manipulation using the expression field. For example I could write an expression which recombines the two substrings but in reverse order. For more information on expressions click the question mark next to the expressions field.

Finally I would also like to recommend the Replace Pattern data converter, which replaces instances of a specified pattern in a string.

Those were the final words on patterns. Feel free to review any parts of the video you found useful or go to help.kapowsoftware.com to find even more answers.

Answers to Problems

Problem Number	Answer
1	'[0-9]'
2	'[\n\r\t]'
3	'[^0-9]'
4	'.*'
5	'colou?r'
6	'\d{4}'
7	'.*\d.*'
8	'\D*\d\D*'
9	'(\D*).*\d.*\d.*'
10	'(\d)\1{3}'
11	'.*(.).*\1.*'
12	'.*?(\\d).*

Snippets

[Click to watch a video describing how to use snippets to share steps among robots.](#)

Creating complex robots can quickly become a messy affair which hogs precious screen real-estate. Putting steps into groups is an easy way to clean up such a robot and simplify the steps it takes to reach the end result.

To group steps you simply select the steps you want to group then press the group button in the tool bar above the robot editor.

Furthermore you can give each group a name when you create it. This makes it easier to keep track of the specific function of the group.

Collecting independent parts of a complex robot into simple groups makes the robot much easier to understand for yourself and others.

Naming groups to remember their insides is essential. We could for example have a group that logs into a site, performs a complex conversion, stores values in a database, or looks something up online.

Thinking about it, I actually have a login group in one of my robots which I would also like to use in some of my other robots. Now I could of course start copying and pasting this group into some of my other robots. That would solve the problem for now but if I needed to change the login procedure in the future then I would have to copy the modified group step into all my robots again.

Let me introduce the snippet concept. A snippet is created and edited as a group step but is stored in a separate file and can be used as a custom step in as many robots as you want.

Having the step information stored in a separate file from the robots, means that changing the snippet in one robot will change it in all of the other robots as well. This can save a lot of time and greatly simplify your robots.

...In addition to containing steps, snippets can also include a list of variables used by the snippet.

It could for example be a login variable containing username and password. This variable is then automatically available in every robot using this snippet.

CREATING A SNIPPET

Let me show you how this all works in Design Studio.

Here is a robot which logs into Zoho CRM, looks up some contact information, extracts it and returns it. The login procedure of this robot has been grouped and would be perfect to have handy for other robots which are also to perform tasks on Zoho.

Creating a snippet from the steps that perform the login sequence couldn't be easier. I simply select the group I already made. Then I select Convert Group to Snippet from the tool bar above the robot editor.

Design Studio now prompts for a name and I choose the name LoginZoho which was already the name of the group.

The snippet is then created which is visualized by the small snippet icon in the lower left corner of the box.

Furthermore the newly created snippet file has been selected in the projects view and the snippet has also been opened in the snippet editor in a new tab. The snippet editor will open every time we modify our snippet in a robot.

I switch to the LoginZoho snippet editor. The snippet editor looks very much like the robot editor. It has a snippet view showing the steps of the snippet, a step view showing the action performed by the active step in the snippet view and a variables view as we know it from the robot editor. Instead of the browser view, the snippet editor has a configuration view where we can write a description of the snippet.

Note that in the snippet editor we can only make modifications to the configuration view and the variables view. If we want to make modifications to the steps in the snippet we will need to do that in the context of a robot editor.

As you may have noticed when looking at the snippet view, the two steps which use the Login variable have been marked with error indicators, pointing out that the variable is not yet present in the snippet.

Accordingly, the last thing we have to do to complete our snippet is to add the Login variable to the snippet. This will ensure that the login credentials will be available to any robot which uses this snippet.

I add it by simply right clicking the variables view and choosing the appropriate type, exactly as I would have done in a robot. In the variable configuration window that now appears I have to ensure that I configure the variable to match the one in the robot precisely. The variable name is correct so I just need to check Use as Input and add default values to the attributes... then I click OK.

Now we have a fully functional LoginZoho snippet.

USING THE SNIPPET

Let me show you how to add the snippet to another robot. Here's a new robot which I also want to perform some task on Zoho. A snippet step is inserted by choosing Insert Snippet Step Before from the tool bar.

An undefined snippet step now appears in the robot. I then choose the LoginZoho snippet from the dropdown in the step view of the snippet step.

The snippet has now been inserted into the robot and can be executed by clicking the end step...

As seen in the variables view, the login variable from the snippet is now available for the robot to use. The small snippet icon to the left of the variable indicates that this variable belongs to the snippet. That means that we cannot edit the variable directly in the robot, but only in the snippet editor. It also means that removing the Login snippet from the robot will remove the variable as well.

If we want the variable to be in the robot permanently then we have to add it manually to the robot, giving it the same name, type and configuration as the login variable from the snippet. This new variable will then take the place of the snippet variable.

Now, if I make a change to the snippet in any of its instances, all the other instances will also be changed. If I for example switch the places of the Enter Username and Enter Password steps and then go back to the first robot, we see that the order of the two steps has been changed here as well.

TIPS

To round off this video let me give you some tips when working with snippets.

TIP 1

Often you can end up with robots having huge variables containing everything needed for that robot. When creating snippets you should ultimately split these variables such that only the attributes needed in the snippet will be included in the snippet variable.

In general you should try to create your types based on function rather than making them robot specific.

TIP 2

To make the snippet as independent from the rest of the robot as possible, make sure to put any non-default robot configuration directly into the steps in the snippet where necessary.

In other words if you have clicked here, then here and made any changes that are important to the steps in the snippet, then make sure to click here in step view for the steps of the snippet and make the same changes.

TIP 3

Always document the context of the snippet by writing a description in the snippet configuration view.

Date Extraction - Simple Case

[Click to watch a video showing how to modify the News Magazine robot to extract article dates.](#)

This tutorial will show you how to easily extract dates from any website using the Date Extraction step in your robot. The tutorial consists of two parts. This first part is a follow-along tutorial with a simple example, the second part is a real case scenario showing a trickier example.

Please feel free to follow along on your computer for this first part.

If you have completed the beginner tutorials you might remember the News Magazine robot. It extracts the most recent stories from News Magazine which is a site made for tutorial purposes. We want to modify the robot to also extract the date and time from the most recent articles.

Start Design Studio and open the Type called post from the Beginner Tutorials folder in the default project. Add a new attribute called date and give it the type Date. Now save the Type, close the Type Editor and open the NewsMagazine robot from the same folder.

Click the Return Value step in the robot view. The robot will now execute to this step. I am going to close the projects view and the source view to get some more space to work with.

Scroll down in the browser view and locate the date and time given above each picture. We are going to add a step which extracts the date and time from each of the three articles.

To do this we right click the tag containing time and date and select **Extract > Extract Date > choose the variable post.date**.

A new window opens which will help us extract the date into the standard date format which is the only format accepted by the simple type Date and thus by our post.date variable.

Let's look at the important parts of Extract Date Configuration window. The field Test Input shows the raw text as extracted. In the field called Pattern we will write the pattern of the date exactly as it is stated in the extracted text. Right now the pattern is "dd MM yyyy" which means that the date consists of date, month and year, separated by spaces.

We see that this corresponds to the format of the date in the extracted text. Design Studio has deduced the pattern for us so if we just want to extract the date we don't have to modify anything. The field Test Output shows us the date in the standard date format as extracted from the Test Input.

Let's say that we also want to extract the exact time that each article was published. This means that we have to expand our pattern to also capture this information. Keeping an eye on the Test Input, add " * hh:mm" to the Pattern. Notice that the Test Output changes to incorporate the time of day.

Let me explain the pattern we added. Spaces and the colon correspond to their respective characters in the Test Input. Asterisk corresponds to "at" in the Test Input but can in general be used to represent any number of non-whitespace characters. "hh" means hours and "mm" means minutes. To get a full list of things to put in the Pattern field you can click the question mark at the top right of the window.

Click OK. We have now successfully extracted the time and date from each article. Test the robot in Debug Mode to confirm this.

Date Extraction - Tricky Case

[Click to watch a video demo showing how to extract dates when date information is spread into multiple places.](#)

This video will show you how to extract the date and time on a site that has date information spread into multiple places. It is recommended to complete the tutorial on Simple Date Extraction before watching this video.

I have made this robot to extract my Skype call history. It logs into Skype and loops through a table which contains my history. The only problem is that the year is not stated directly in the date and time column but only in the blue bar above. Somehow I have to combine the two pieces of information. Luckily this is easily done using converters.

Before entering the loop I add a step which extracts the text in the top bar into the variable called Year. Inside the loop I insert a new step which I choose to have the Extract action. Then I select the date tag from the first row of the table and use the yellow square button to the right of the Address Bar to use it in the Extract step.

Now, to combine this extraction with the Year variable, I add a converter under the Action tab of the extract step. I choose the converter called Evaluate Expression which allows me to append the value from the variable Year to the extracted date.

An Evaluate Expression Configuration window opens. The Test Input field shows the date as extracted. In the Expression field I simply write "INPUT" with capital letters, which is the extracted date. I follow this by a plus and a space in quotation marks, this adds a space after the date. Then I add another plus followed by "Year", representing the variable containing the year which we extracted earlier.

Looking at the Test Output I verify that the two extractions have been combined into one text. To learn more about expressions I can click the question mark next to the Expression field. Click OK.

I now add another converter, the same as used in the Simple Date Extraction Tutorial, called Extract Date. The Output of the previous converter is used as input for this converter.

The configuration window opens for the Extract Date converter and I insert a new Format pattern and delete the default one given by Design Studio. Now, just as in the Simple Date Extraction Tutorial, I add the pattern to extract the date from the test input and let the converter convert the date to the standard date format. "MM dd hh:mm MM yyyy". The month is given two times but that is not a problem. The first occurrence will simply be ignored.

I click OK, choose to extract into the Date variable and check that the date and time has been extracted successfully.

That concludes this tutorial and demo on extraction of dates.

API

[Click to watch a video, which takes you through the creation of a robot that uses JSON and a REST call to access the LinkedIn API.](#)

Introduction

This video will take a look at how to utilize the power of REST web services, APIs, OAuth and JSON in the creation of a robot. Specifically we will go through the process of automating the posting of a share to a LinkedIn account based on content extracted from another website. This process involves the following:

1. creating an app through a LinkedIn developer account
2. looking at the LinkedIn documentation reference and understanding how the share API works
3. creating a robot which extracts from News Magazine and posts to LinkedIn through a REST call to the LinkedIn share API, and finally
4. scheduling execution of the robot and adding users to it from the Management Console.

After watching, you should be able to access and call the LinkedIn API. Even if you are only interested in other APIs, this video will still serve as a fine introduction.

OAuth and the LinkedIn API

Before we can start working on the robot in Design Studio, we need to get access to the LinkedIn API. This is only possible with a developer account, but fortunately it is quite easy to get one. Start by going to developer.linkedin.com and sign in in the upper right corner. In the popup window that opens, type your username and password and allow the LinkedIn Developer Network to access your account.

Once you have successfully logged in, click on the link to API Keys, in the dropdown in the upper right corner. This will give you a list of the applications associated with your account. The list should be empty unless you have already created some LinkedIn applications. Add a new application, and fill in the form. Apart from filling in all the required fields, you should also check off any permission that your robot might need. Since we need to post to the users account, we will check the `rw_nus` permission. When you are done, click Add Application at the bottom.

LinkedIn now gives us back a page showing the OAuth credentials needed to access their API. We leave the page open so we can have access to these credentials when we need them.

In a new tab, we open developer.linkedin.com again. This time we go to the Documentation dropdown box and click REST APIs. We need to find the part of the API which lets us share something to an account on the user's behalf. We choose Share and Social Streaming in the Documentation Menu on the right, then choose Share API from the submenu. Now we are on the page for documentation of the Share API.

Scrolling down a bit, we see what a sample payload for the Share API looks like. The example is in XML, but we will be posting using a JSON payload instead. The translation from XML to JSON is pretty straight forward as we will see. Above the example is a table which shows all the fields available to the Share API. It is possible to set a comment, a title, a url, an image and a description.

JSON and REST call

Now that we have OAuth credentials for the LinkedIn API, it is time to start building our robot. We create a new robot called LinkedInShare. Then we add a variable of the type OAuthCredentials, name it

credentials and mark it as an input variable. It is important to make it an input variable so we will later be able to schedule the robot in the Management Console. Then we give it the following default values which will let us call the LinkedIn API: We write LinkedIn in the serviceProvider attribute, copy the API Key to the consumerKey attribute, Secret Key to consumerSecret, OAuth User Token to accessToken, and OAuth User Secret to accessTokenSecret. As you might notice, there is no strict naming convention these four tokens. Hence the names differ between LinkedIn and Design Studio. Then we click OK.

We now need to create a new type: One into which we can extract the front page article from a website called News Magazine. We create a new type and call it Share.type. For this type we should name each attribute according to the input fields specified by the Share API. Going back to the documentation of the Share API, we see that the fields we are worried about are called title, submitted-url, submitted-image-url, and description.

In Design Studio we add the four corresponding attributes to our type: title as a short text, ... submitted_url as a short text, ... submitted_image_url as a short text, ... and finally description as a long text. Note that we use an underscore instead of a hyphen since hyphens can't be used in valid attribute names. Luckily, LinkedIn does not distinguish between the two. That's it! We save the Share type.

Going back to the robot, it is time to start the fun part, which is building the robot. We start by adding two variables, one of the type we just created, and one of the simple type JSON. The JSON type variable should be able to contain the JSON payload which will be used in the API call.

Starting with the jsonPayload variable, we add it to the robot and edit the default value of the variable to reflect a payload template. I have made the template ahead of time. You can copy the template for the payload from the text associated with this video:

```
{
  "comment" : "News Magazine article of the day",
  "visibility" : {
    "code" : "anyone"
  }
}
```

The payload template contains a default value for the comment field. This could be created dynamically if you wanted to. It also contains a value for the visibility of the share with the code "anyone". This means that anyone, not just connections, will be able to see what we post to the user's profile. Save the variable.

We then add a variable of the type Share.

Now all we need to do, is to load News Magazine, extract from the front page story, add that content to the payload and call the LinkedIn API with a Call REST Web Service step.

News Magazine is most easily loaded by inserting a snippet step and choosing the snippet LoadNewsMagazine for it. This is one of the snippets that comes with the default project when you install Kapow.

Executing the snippet step, we are able to see the front page of News Magazine. From the featured article on the front page, we extract the title, url, image url and description into the share variable. The url is extracted from "Continue Reading" and the image url is extracted by right clicking the image and extracting the url. ...

To build the payload we now have to open the jsonPayload variable. This can be done by right clicking it and choosing insert step>>open variable. The value is now showed in the JSON view. Click the plus icon in the toolbar above the JSON view to expand all lists and objects and view the entire content of the variable.

Inserting the content from News Magazine into the payload is very easy. Simply right click the comment property and choose Modify>>Insert>>After. In the Name field we write "content". For the Value field, choose Generate From Variable from the value selector on the right. Now we can choose our share variable in the field called Variable to Format. Click OK to finish.

The JSON payload should now have been correctly formatted for our REST call. We insert a new action step as the last step before the end step and choose for it the Call REST Web Service action. All we need to do is configure this step and the robot will then be ready to be deployed. Here is how to do it.

From the Share API documentation we copy the URL and paste it into the URL field.

The request method is POST, which is also stated in the API documentation.

From the dropdown just below the request method, we choose that we want to specify the raw body of the request rather than individual parameters.

For the request body we select variable from the value selector and choose our JSON payload variable.

Correspondingly we choose application/json as the content type.

Going down to the bottom of the Step Action, we need to specify credentials for the REST call. We have already prepared these. Choose OAuth as authentication type, and select the OAuthCredentials variable.

That was the final step in finishing the robot and it should now be ready to for deployment. First however, we will run it in debug mode to check that it works as expected.

We switch to debug mode and run the robot. If it is successful, there should not be any error messages.

Next, we log into LinkedIn to check that the share has been posted successfully. It may take a while before the share appears.

Once we have ensured that everything looks good, it is time to upload the robot to the Management Console in order to schedule it and add multiple users.

Schedule the robot

Going back to Design Mode from Debug Mode, we upload the robot to the Management Console and click the link that appears to the Management Console. Since our robot uses the OAuthCredentials type as input variable, setting up the scheduling is a bit different than you might be used to. Here is how to do it.

In the repository, we go to the OAuth section. Here we add a new application, namely our LinkedIn application. We name it "LinkedInShare", choose LinkedIn as our service provider, copy our application API Key to the consumerKey field, and our Secret Key to the consumerSecret field. We leave the Scope and Callback fields as they are and click save.

Then we add a user. We call the user "user1", click next and click the link to authorize the user. In a new window, our application will now request permission to access whatever LinkedIn account we are logged in to. Allow access and the Callback page will confirm that permission has been granted. Close the window or tab to go back to the Management Console.

Now we click next, and then finish, to finally add the user to our application. Multiple users can be added in this way, but let's keep it simple and stick to just one user at the moment..

Clicking on the Schedules tab, we are now going to create a schedule for the robot. We configure the schedule, give it a name, set it to run daily, and add a job to the job list. We choose to add a single robot and select the LinkedInShare robot. In the last step of the dialog, we choose the user we created for OAuth and click finish and save the schedule.

The task has now been completed. We have set up an automated process which uses the LinkedIn API to post daily updates to a LinkedIn profile.

You should now be able to use the LinkedIn API. If you want to learn more about the using OAuth to access sites like Salesforce, Facebook, and Twitter, please consult the documentation at

help.kapowsoftware.com, where you will find a section called OAuth in the Management Console User's Guide.

Chapter 4

Design Studio

Design Studio is the application for creating [robots](#) and [types](#). In Design Studio, you can also debug your robots and create database tables for types that need to be stored in databases.

Design Studio, an integrated development environment (IDE) for robot development, is all you need to design robots and types.

Robots are programmed in an easy-to-understand visual programming language with its own syntax (structure) and semantics (meaning). To support you in the construction of robots, Design Studio provides powerful programming features, including interactive visual programming, full debugging capabilities, an overview of the program state, and easy access to context-sensitive online help.

Design Studio also lets you create the types that are used by robot variables for data extraction and input. With Design Studio Type Editor, you can design types that are modeled after real-world data. In the most common case, a type is designed to hold the data that a robot extracts from a data source.

Organization

The Design Studio section of help is structured as follows: First, you are introduced to the essential concepts of Design Studio. Then you are taken on a tour of the user interface and provided with an overview of the core building blocks of any robot. With the basics firmly in place, we get to the tutorials that show you how to use Design Studio to create robots that do something useful. The tutorials get gradually more advanced until you are ready to create robots that perform the tasks defined by you. The tutorials are the meat and bone of this section of help and it is important that you master them before proceeding.

Before You Read On

Before you proceed, we recommend that you read [Introduction to Kapow](#), which will introduce you to Design Studio and the context it is used in, and take you through basic [tutorials](#).

Note To access tutorials, you must have access to the Internet.

To work with Design Studio, you should have a basic understanding of programming, HTML, and JavaScript.

Other Resources

Additional information on Design Studio is available in [the reference documentation](#).

Introduction to Design Studio

Design Studio is a programming environment for creating robots and designing types. Robots are created using a special-purpose programming language with its own syntax and semantics. Like other

programming environments, Design Studio uses several concepts that you, as a robot designer, must understand to fully comprehend the workings of Design Studio. The purpose of the introduction is to define the most important concepts and we recommend that you refer back to this section whenever necessary. You may not understand all the Design Studio concepts right away; they will become clearer as you explore Design Studio and start creating robots.

Robots

The most important concept in Design Studio is a robot. A robot is a program designed to accomplish some task involving a data source, usually a web site, but it could also be an Excel document or a database. Typically, one robot is written per task per data source. For example, you would create one robot for extracting news from <http://cnn.com>, another robot for extracting news from <http://yahoo.com> and yet another robot for extracting product information from an online product catalog.

Basically, a robot can be programmed to do (automatically) everything you can do in a browser, and to extract data from a database or an Excel document to combine with data stored in a database or file.

Robot Execution Mode

Kapow Design Studio supports two design-time robot execution modes: Minimal Execution (Direct) and Smart Re-execution (Full). This topic provides details about the two modes.

When creating a new robot, you can select execution mode in the new robot wizard. Use the [Design Mode](#) tab of the robot configuration to view or change the execution mode. Note that the choice of robot execution mode only impacts the execution in Design Mode, and not in Debug Mode or at runtime in RoboServer.

Minimal Execution (Direct)

The Minimal Execution (Direct) mode is the traditional Design Studio execution mode. All robots written in versions prior to 9.5 will use this execution mode, which is also the default mode for new robots.

When you click a step in Minimal Execution mode in the robot graph, Design Studio takes the shortest direct path to that step, skipping any previous branches and iterations that are not on the direct path.

Consider the example below:



During runtime execution, the robot would normally execute steps A, B, C and D before reaching step E. But in Design Mode, clicking step E result only in the execution of steps A and D.

Similarly, if the step resides inside a loop, only the selected iteration is executed.



Since the iteration counter is set to 3, clicking step C cause only step A, B and C to be executed once, where step B selects the third iteration.

The Minimal Execution mode is optimized towards executing as few steps as possible. This mode is useful when you have large robots and steps that take considerable time to execute, such as steps that interact with complex websites. Generally, we recommend Minimal Execution for most data collection use cases and for robots that perform significant interaction with external sites.

The drawback of Minimal Execution mode is that it requires user assistance to select the path to a given step whenever it cannot execute directly to the step using the default path; for example, try steps in a path may prevent a robot from following the topmost branch.

See the following example.



When clicking step C, Minimal Execution mode is not able to proceed if the test fails in the Test Value step. In this case, the user must explicitly click the bottom branch of the try step first, to guide the execution path towards step C.

Smart Re-Execution (Full)

In Smart Re-execution mode, the way that the robot is executed in Design mode is similar to the way it is executed at runtime or in Debug mode.

As an example, when you click step C in the following robot, it automatically executes through the bottom branch of the Try construct when the test fails in the Test Value step:



The blue exclamation mark icon on the Test Value step indicates that the error handling to Try Next Alternative was triggered.

With loop steps, all iterations up to and including the selected iteration are executed when clicking a step inside the loop.

In the following example, clicking step C causes execution of three iterations of the loop.



Further, if clicking a step in a branch below a loop, all iterations of the loop are executed. As an example, see the following robot.



Clicking step D causes execution of step A and repeated execution of steps B and C (as many times as there are iterations in loop B) before finally stopping at step D.

The Smart Re-execution mode is particularly useful when working with global variables, and when you have subsequent steps in the robot that depend on accurate variables. This mode may be useful for building a payload for a web service (REST or SOAP) call, or constructing an Excel document. The XML or Excel document that is being populated resides in a global variable, while its content is added during the execution of a loop. In a branch below the loop that populates the document, the robot takes the entire document and posts it to a web service or similar. In this case, the Smart Re-execution mode makes it easier to build the robot, as it ensures that the document is populated when testing the web service call in Design Mode.

In Smart Re-execution, the interaction with the external world in the form of websites, databases, or web services is cached. Caching avoids re-execution of steps unless the prerequisite for storing the execution result has changed (such as a variable that determines which URL to load). Smart Re-execution has a higher memory footprint than the Minimal Execution mode.

The Smart Re-execution mode is the only mode that supports [Device Automation](#) robots.

We do not recommend Smart Re-execution mode for large robots with significant interaction with the external world, or for long-running robots. The execution time as well as memory usage are too high in these cases.

To cut down on the execution time while designing the robot, you can right-click a branch and disable it in Design Studio. A similar setting can be applied in Debug Mode. Additionally, you can disable the branch based on a specified condition in select iterations.

Connection configuration

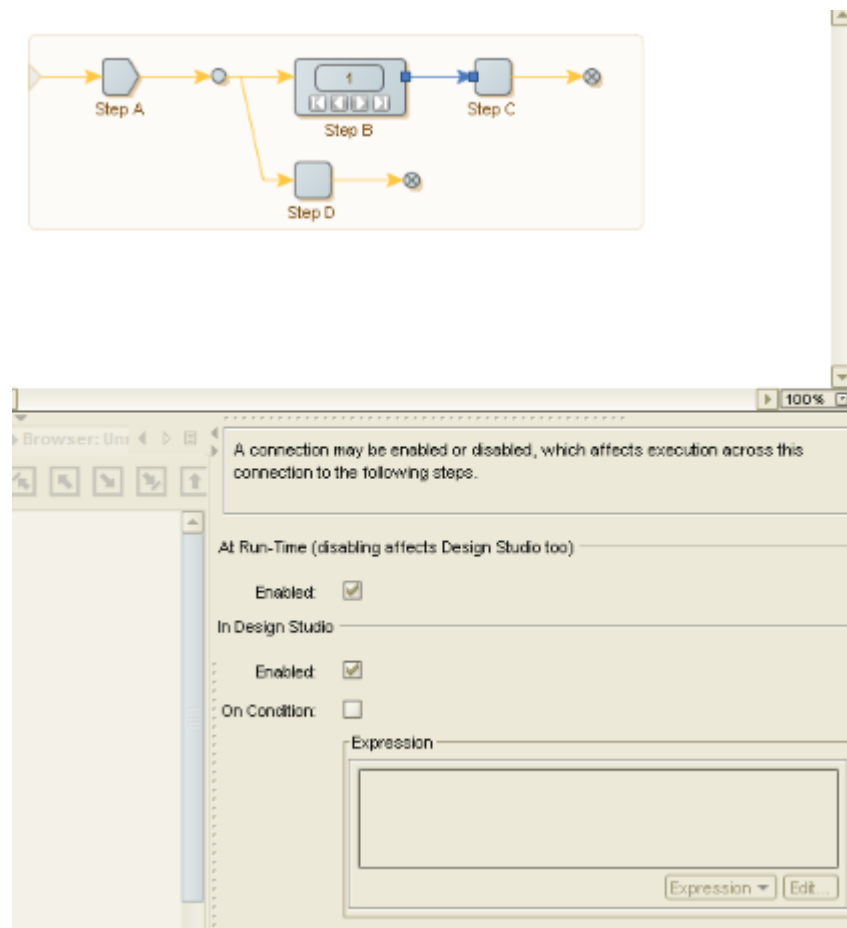

The [Design Mode](#) tab of the robot configuration also features an option "Avoid External Re-execution". When checked, it is ensured that steps are never re-executed, even when the cached result of the previous execution cannot be used. In this case, you can still edit the robot, but without a current input state to work on. Use this option only to meet requirements for interaction with the external world to avoid re-execution (for example, if re-execution would result in incorrect or duplicate data in a partner's system).

Important Some step actions are not available in the Smart Re-execution mode. For a list of unavailable steps, see the "Execution Mode" section in the [Kapow Limitations](#) topic.

The Robot State

When a robot is executed, it works on a robot state, which consists mainly of four elements:

- Windows
- Variables
- Cookies
- Authentications

The Windows element corresponds to the currently open windows, each containing a page. This page could be an HTML page, a spreadsheet, an XML page etc. The page has a given Page Type depending on what type of page is loaded into the window and the look of the Page View and the steps you can insert in your robot depend on this type. At least one window is always open, and one window is marked as the current window. The variables element contains the current values of the variables. The cookies and authentications elements are the HTTP cookies and authentications, respectively, received during communication with a web server.

Steps

A robot is made up of steps, which are building blocks in a robot program.

There are four types of steps:

- Action
- Try
- Group
- End



A step works on a robot state and processes it according to the configuration of the step. A step has an input robot state and generates an output robot state. The only exception is the End step. End steps mark the end of a branch in a robot, but not the end of a robot. For example, the robot does not necessarily stop execution after an end step. End steps are the only steps in a robot that do not have outgoing connections.

Steps may have properties, such as a step name, a list of tag finders, a step action and error handling. While Action steps have all these properties, other types of steps only have some.

The step name provides a symbolic name for the step, such as "Extract Headline" and "Load Search Page." In the preceding robot, the step name is "MyStep".

The finders find the elements (HTML/XML tags or Excel cells) in the page that the step action should work on. Some step actions require a single element, whereas others can handle more than one element. Some step actions accept no elements at all. There are two kinds of finders: Tag Finders that find tags in HTML or XML pages and Range Finders that find cells in Excel pages.

The step action is the action that the step performs. The action is the "heart and brain" of the step, and it is the selection of the right step action that is the challenge of robot writing. For example, an Extract action can extract the text from a tag in an HTML page and store it in a variable. A Click action can load the URL residing in an <a>-tag and replace the page of the current window in the robot state with the newly loaded HTML page. An action usually changes the robot state. For example, the Extract action changes the variables, and the Click action may change the pages/windows, the cookies and the authentications.

A step can be executed. A step that is executed accepts a robot state as input and, by applying the finders and step action in turn, produces an output robot state. The output robot state is then passed to the following step and becomes its input robot state. Some step actions are "termed loop" actions and steps having such actions are called "loop steps." A loop step may generate zero or more output robot states, and cause the following steps to be executed once for each of them.

You can group steps together in expandable Group Steps. The figure below shows an example of an expanded Group step with a collapsed Group step inside it.

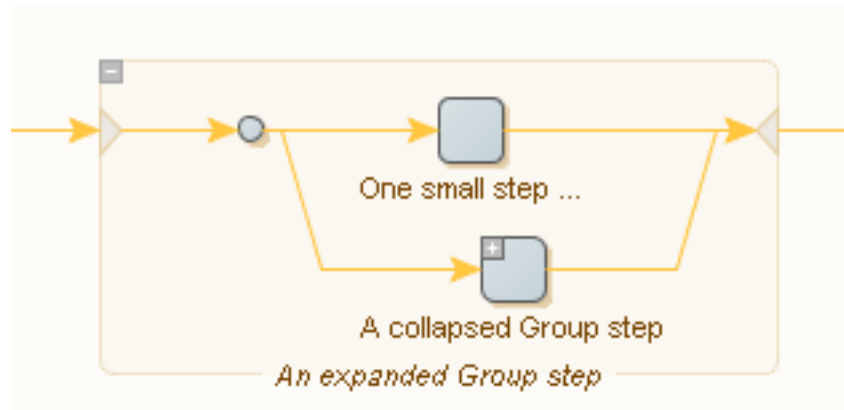

A step is valid if it is properly configured so that execution can be attempted. For example, if a step has no action, it is invalid since execution cannot be attempted.

A step definition also specifies [error handling](#).

Connections and Execution Flow

Use connections to determine the execution flow between steps.

Note Examples in this topic are based on the [Minimal Execution \(Direct\)](#) design-time execution mode.

Consider the following simple robot:



This robot consists of three steps: Step A, Step B, and Step C. Assuming that no errors occur, and that each step generates exactly one output robot state, the robot is executed as follows: An initial robot state is generated and used as input to Step A (being the first step). Step A produces an output robot state. This output robot state is the input robot state of Step B. Similarly, Step B produces a robot state, which is the input robot state of Step C. Once Step C has executed and produced an output robot state, execution completes. In short, the execution of steps is described as follows: "A, B, C."

Sometimes, a step generates no output robot state when executed. This happens when an error or a test step causes execution to continue somewhere else in the robot (see [Conditions and Error Handling](#)).

Steps containing a loop action may process the input state several times, each time outputting a distinct robot state. Consider the following robot where step B contains a loop action:

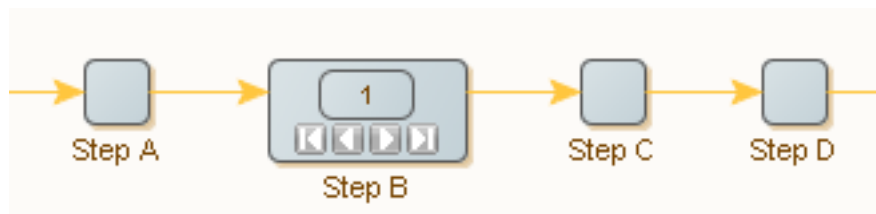

Assuming that there are no errors or test steps, that step B outputs three robot states, and that all other steps output exactly one robot state, the steps are executed in the following order: "A, B[1], C, D, B[2], C, D, B[3], C, D", where B[N] refers to the N th iteration of the loop action contained in step B. Note that the output robot states by step B are different robot states: each iteration will output a new robot state. Hence, step C will receive a new input robot state each time it is executed.

See the [Branches, Robot States, and Execution Flow](#) tutorial for more information.

A step can connect to more than one step. This is called "branching". Consider the following robot:

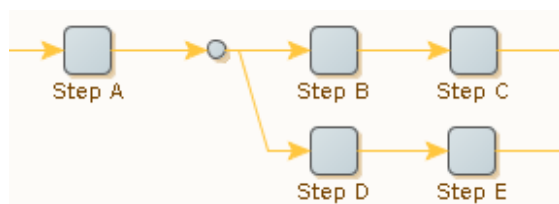

In this robot, step A is followed by a branch point, where the connection splits out in two branches. One branch consists of step B and step C, and another consists of step D and step E. All branches coming out of a branch point are executed, one after another. Therefore, assuming that no errors or test steps change the control flow and that each step generates exactly one output robot state, the preceding

robot is executed as follows: A, B, C, D, E. However, it is important to note that step B and step D each receives a copy of the same output robot state produced by step A.

Branches can merge, and in complicated ways. Consider the following robot:

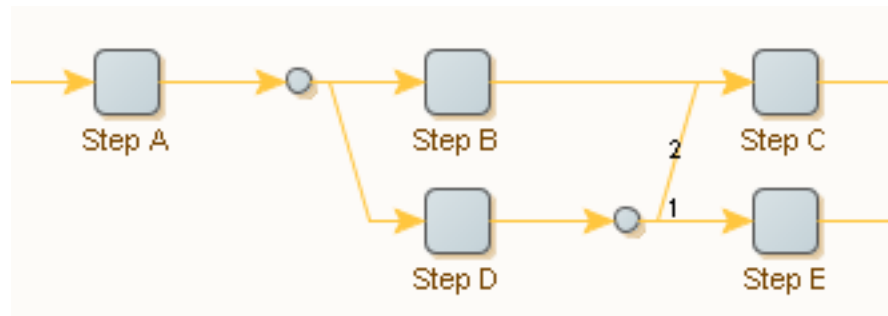

This robot illustrates how connections can be explicitly ordered. In this robot, the branches of step D are executed in the order specified by the numbers: step E is executed before step C. If an order is not specified (by numbers), connections are executed top-down. Thus, assuming that there are no test steps, that no errors occur, and that each step generates exactly one output robot state, the robot is executed as follows: A, B, C, D, E, C. The first time step C is executed, it receives the output robot state produced by step B; the second time step C is executed, it receives the output robot state produced by step D.

Sometimes you want to select (execute) only one of several branches, depending on circumstances. The [Conditions and Error Handling](#) topic shows how to do this.

Conditions and Error Handling

A robot may use different approaches in different cases. The cases may be distinguished either based on explicit tests; by evaluation of conditions, or because errors occur and need to be handled.

Note Examples in this topic are based on the [Minimal Execution \(Direct\)](#) design-time execution mode.

Conditions change the flow of execution based on the content of the input robot state (such as the presence of a particular tag in an HTML page). Error handling is about changing the flow of execution when particular errors occur (for example, some anchor tag is not found on the HTML page as expected and cannot be clicked). Often a situation can be seen both ways: An anchor tag should be clicked if found (this is a condition), or the robot can try and click it to handle the error (if it is not found). In some cases, what is commonly thought of as a condition is too complex to be written up as such (for example, a condition saying "if this particular page can be loaded without error"). In such a case, try and load the page and treat any error as an indication that the condition failed.

Other errors are signs of genuine problems with the robot or the web site being accessed. For example, the web site may be down and cause a page loading error, or a tag finder might fail to find a needed tag due to a dramatic page layout change of an HTML page. A particular error may be considered a failed condition in some circumstances, and a genuine error in other circumstances. The interpretation depends on the robot.

Because of this blurred boundary between conditional execution and error handling, Design Studio provides both features in a unified way. For every step, you can configure what to do in case an error

occurs. Furthermore, steps with a test action (based on a condition of some sort) reuse the same approach, meaning that if the condition is not met, the (default) action is applied as if an error occurred.

For each step in the robot, you can configure the desired reaction to errors. Two useful error handling options are described here; see [How to Handle Errors](#) for information on the other options. The first option is closely linked to the Try step.

The Try step is similar to a branch point because it may have several branches going out from it. It differs from a branch point because branches beyond the first one are executed only if a step on the preceding branch encounters an error which it handles based on the Try Next Alternative option. Consider the following robot and assume that each ordinary step is expected to output exactly one robot state:

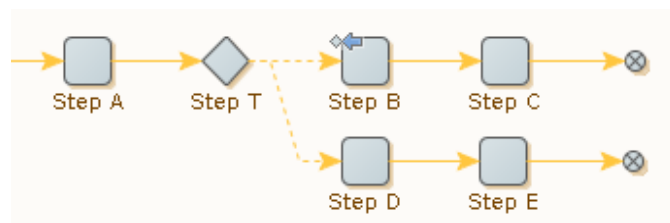

The icon indicates that step B is configured to handle errors by "Trying Next Alternative."

If Step B executes successfully, step execution is as follows: "A, T, B, C." Because the first branch going out from T executes without error, the second branch is not executed at all.

If, on the other hand, Step B encounters an error, then the execution of steps is as follows: "A, T, B, T, D, E." After the error in Step B is handled, execution does not continue at the following step, but instead at the beginning of the next branch going out from the Try step.

Each branch from a Try step represents one possible way to proceed from that point. Steps near the beginning of each branch probe if execution along the branch is a viable approach (and otherwise effect a "Try Next Alternative"), while later steps do the actual work when the branch turns out to be the right one for the case at hand. The probing steps near the beginning of a branch may be either test steps, or any kind of steps that, if they encounter an error, indicate that this branch is not the way to proceed. There may be any number of such branches going out from a Try step.

As with ordinary programming languages such as Java, JavaScript, C# or similar, the preceding robot is similar to an "if-then-else" construct: The first branch after the Try step contains the condition (the "if" part) and the "then" part, while the last branch contains the "else" part. Should there be more than two branches, then the ones between the first and the last ones are like "else-if" parts.

If the first branch attempts to do some action that may error, the example can also be likened to a "try-catch" construct: The first branch is the "try" part, while the second branch is like the "catch" part.

Another error handling option, Skip Following Steps, provides a more compact way of expressing a common special case, which is exemplified by the following robot. The step that can encounter an error is the first one on the first branch, and the second branch does nothing.

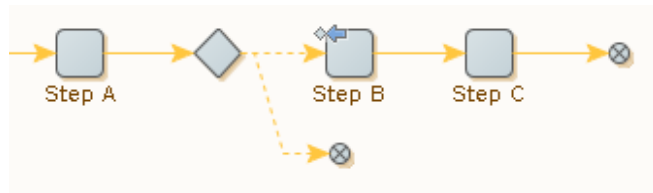

The effect is to skip execution of the steps after step B if it encounters an error. The same effect can be achieved without the Try step by using the error handling option "Skip Following Steps" (which is the default), in the following way.



Location and Location Code

When an error is handled, it is possible to report it back to the caller of the robot, or to log it. In both cases, a message is included that briefly describes the error, together with a location and location code for the step that encountered the error.

The location of the step that encountered the error is the list of steps (including iteration numbers) necessary to execute to reach that step from the first step. Consider the following robot.

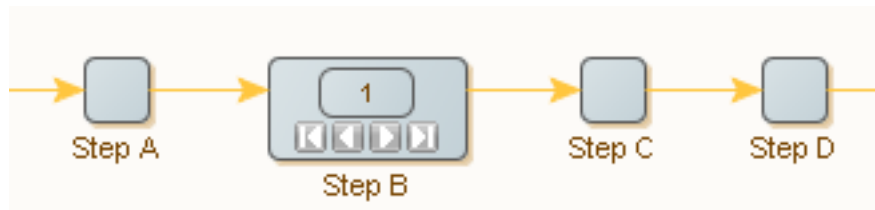

If Step C reports an error on the second iteration of Step B, the location is written as: "step A - step B[2] - step C." Note that the location contains the step names and iteration numbers, separated by hyphens. Branch points are omitted.

The location code is similar to the location, but the name of each step is replaced by a unique identifier for that step, thereby avoiding name clashes. For the preceding location example, the location code may be: {a-i1-a}. Use the location code in Design Studio to go directly to the step that reported the error (using **Go To Location** on the **Edit** menu).



Note The iteration number in the location and location code is 0 indexed, so the first iteration is: {a-i0-a}

Snippets

A snippet is a group of steps that can be reused in several robots. A snippet is maintained in a file separate from the robot. Whenever the contents of a snippet is changed in one robot, it is automatically updated in other robots that uses the same snippet. A snippet is inserted into a robot using the Snippet step, and edited in-line. Snippets contents cannot be edited without being inserted into a robot.

For additional information, see the [Snippets](#) tutorial.

The Snippet step inside a robot is in many ways similar to a Group step. Although, the steps inside a Group step are part of the robot, the steps inside a Snippet step are maintained in a separate file and can be reused in other robots inside the same project. A robot is incomplete and cannot execute if a snippet that it references is not present in the project.

After selecting a group of steps to convert to a reusable snippet, click  "Create snippet from selection." If only a single group step is selected, it can be converted to a reusable snippet by clicking  "Convert snippet to group." A snippet can be easily embedded into a robot by clicking the "Convert snippet to group"  icon after selecting a snippet step.

A snippet can also define a set of variables included in the set of variables of any robot that uses the snippet.

A snippet can have a description. This is edited in the Snippet Editor and is shown on every occurrence of that snippet in robots.

Variables and Types

Variables and Types are important concepts in Design Studio.

Every variable can be associated with a default initial value that it retains unless the robot explicitly reassigns it, which it often will as values are extracted and manipulated during the execution. Most robots output the values of variables, by returning them to the caller or inserting them in a database. Robots can also take input values which are assigned to specific variables marked as receiving their values from input. These are called input variables.

You define each variable as either complex or simple.

Simple Variable

A simple variable does not define any attributes, but only represents the type of a single value. Thus, a variable of a simple type contains a single value, for example a text string, and is referred to only by its variable name, such as Username. Simple types are built-in and cannot be edited, or created.

- Useful when extracting temporary data or as global counters.
- Commonly used as temporary variables, internal to the robot.
- You cannot use a simple type for input variables.
- You cannot output the value of a simple type.

Complex Variable

A complex variable defines a set of attributes. Each complex variable denotes several (named) values. We generally refer to each attribute such as "title" as a separate variable such as "Book" and denote its

value using the fully qualified attribute name, such as `Book.title`. You can create complex types within Design Studio to suit your needs.

Complex variable values are output in various ways. For example, a robot extracting news from a web site might output the values of news variables; each news variable would have a complex type with attributes such as `headline`, `bodyText`, `date`, and `author`; and each news value to output would comprise a possibly unique subvalue for each named attribute.

For robots containing input variables, they must be specified as part of the robot's input with values assigned to the input variables. For example, a shopping robot that orders books at <http://amazon.com> might depend on input values containing user and book information. These might be assigned to two input variables in the robot called "user" and "bookInfo" of type "User" and "BookInfo." The following figure shows how a robot accepts input values and generates output values.

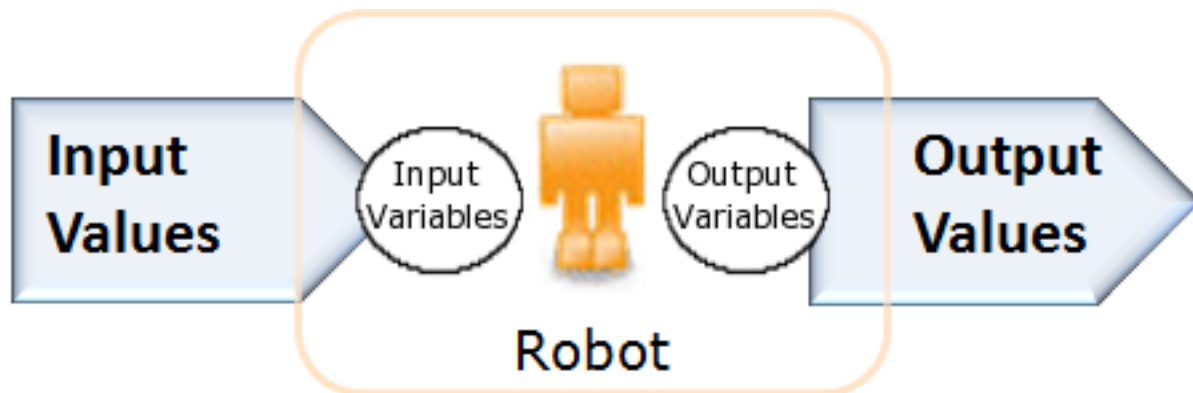

The figure shows robot input-output. Input values are assigned to input variables, and the values of some variables are output. Only variables of complex types can be assigned from input or have their values output.

Libraries and Robot Projects

Robots and types are organized in libraries. A library is a collection of robot definitions, type definitions and other files needed to execute the contained robots. A library serves as the deployment unit for robots. Use a library to bundle robots and their required files when you want to distribute and deploy the robots in a runtime environment, such as RoboServer.

In Design Studio, you can work on one or more robot projects at any time. The purpose of a robot project is to develop a robot library. A robot project contains the robot library that you are developing a given set of robots in, as well as other files that are useful for your work on the robot library. Files placed in the library may also be accessed by robots using a special library protocol.

Thus, a robot project is what you work on when you are developing robots, and a robot library is how you distribute and deploy your work.

Shared projects are deployed on a Management Console and connected to a project on your local Design Studio computer. Management Console projects can be shared between several Design Studios. The [Shared Projects View](#) provides visual indication of the status of the shared project files as well as tips with descriptions.

Naming policy

Kapow imposes the following naming policy, which applies to project names, schedule names, folder names (paths), and folder items including robots, types, snippets, and resources uploaded through the API.

- Illegal system characters are allowed, but they generate a warning message.
- System reserved words are allowed, but they generate a warning message.
- Empty names are not allowed, and they generate an error message.
- Names that exceed 243 characters are not allowed, and they generate an error message.
- Names with special HTML formatting are allowed, but they generate a warning. The HTML formatting is removed.

Note the use of a period "." in file names:

- Files and folders starting with a period "." are treated as hidden (hence all files in hidden folders are also hidden) and they are not shown on the project tree.
- Hidden files are not included in project synchronization.
- Robots, snippets, types, texts, and database mapping files cannot have names starting with a period ".".
- Folders cannot have names starting with period ".".

Name Conversion Algorithm

Typed name	Result
'<t> aaa </tag>'	'aaa'
Note '' denotes the start and end of the string.	Note The HTML tags <t> and </tag> are removed. The space before and after the actual folder/project/schedule name is also removed.
'< t> hello '	'< t> hello'
	Note The tag < t> is kept because it is not a valid HTML tag. The space after the actual name is removed.

Typed name	Result
'com1 /*** /& @'	'com1/***/& @' <div style="background-color: #f0f0f0; padding: 5px;"> <p>Note Because "com1" is a reserved word for some operating systems, it generates a warning; however, it is a valid name for a folder, project, or schedule. An asterisk "***" is an illegal character. Kapow accepts it as a valid name but generates a warning. Note that entering a name with reserved words and illegal characters can result in errors when other users download the project to local computers where the operating system does not support the names as valid file names. HTML entity numbers such as &#38; are converted to actual characters.</p> </div>

Device Automation

Requires a Desktop Automation License

Device Automation feature helps you create robots that can automate native Windows and Java applications on your network computers.

Device Automation Logic

Robot Language in Kapow was originally designed for accessing HTML and was developed at a time when HTML pages were mostly static. Device Automation Language is designed to handle web sites with server site state and perform desktop automation. Device Automation Language in Kapow is a real-time language based on some ideas from patterns of interaction in concurrent systems described in CSP (Communicating Sequential Processes). The steps in device automation move forward only, meaning that branching as it is in Robot Language when branches are executed sequentially one after the other and the state is reverted at the start of each branch, is not present in Device Automation Language. The state of the execution is on the remote device and it is not possible to go back in the robot. Branching only occurs as part of language constructs, such as a conditional step. The branches are alternative branches and only one branch is executed for a given execution of the step containing the branching.

Error handling is also different in Device Automation Language than in Robot Language. In Device Automation Language error handling is not specified for each and every step, but is made more explicit in the robot graph by the introduction of a try-catch step that catches errors occurring within its scope and defines how they are to be handled.

One of the means to avoid robot execution issues utilized in Kapow Device Automation logic, is the guard or guarded choice. When a robot clicks in the interface, it cannot foresee the consequence nor can it determine when the application is done processing the event. This is why it is important to use guards when you design your Device Automation robot. In Kapow you can use location and timeout guards to make sure the robot finds the required elements and works as designed.

When designing a robot, think how a user interacts with the UI of the program. For example, if you need to type some text in the text field, first click the field and then type the text.

Newly inserted steps are not executed unless you click Single Step in the Device Automation editor.

Device Automation Robots

A robot in Device Automation Language is a workflow consisting of a sequence of steps that are executed in the order they appear in the sequence. Device Automation robot may be executed in various ways, such as from a schedule, via an API, from website robots, from another Device Automation robot, and etc.

Automation Devices

Automation Devices are computers that you want to automate. A robot has access to a number of Automation Devices. A device is basically a computer running Windows system. A device may have a number of applications running on it or robots can start new applications.

Steps

Steps are the basic building blocks of robots in Device Automation Language just as they are in legacy Robot Language. In Device Automation all steps have one entry point and one exit point, except for a few selected steps that have no exit point. All steps that have some form of branching are in a group-like structure that can be expanded and collapsed. All steps that have a group-like structure are called composite steps.

Device Automation Editor

The Device Automation editor contains the following windows. You can undock and move any of the editor's windows to make editing more convenient.

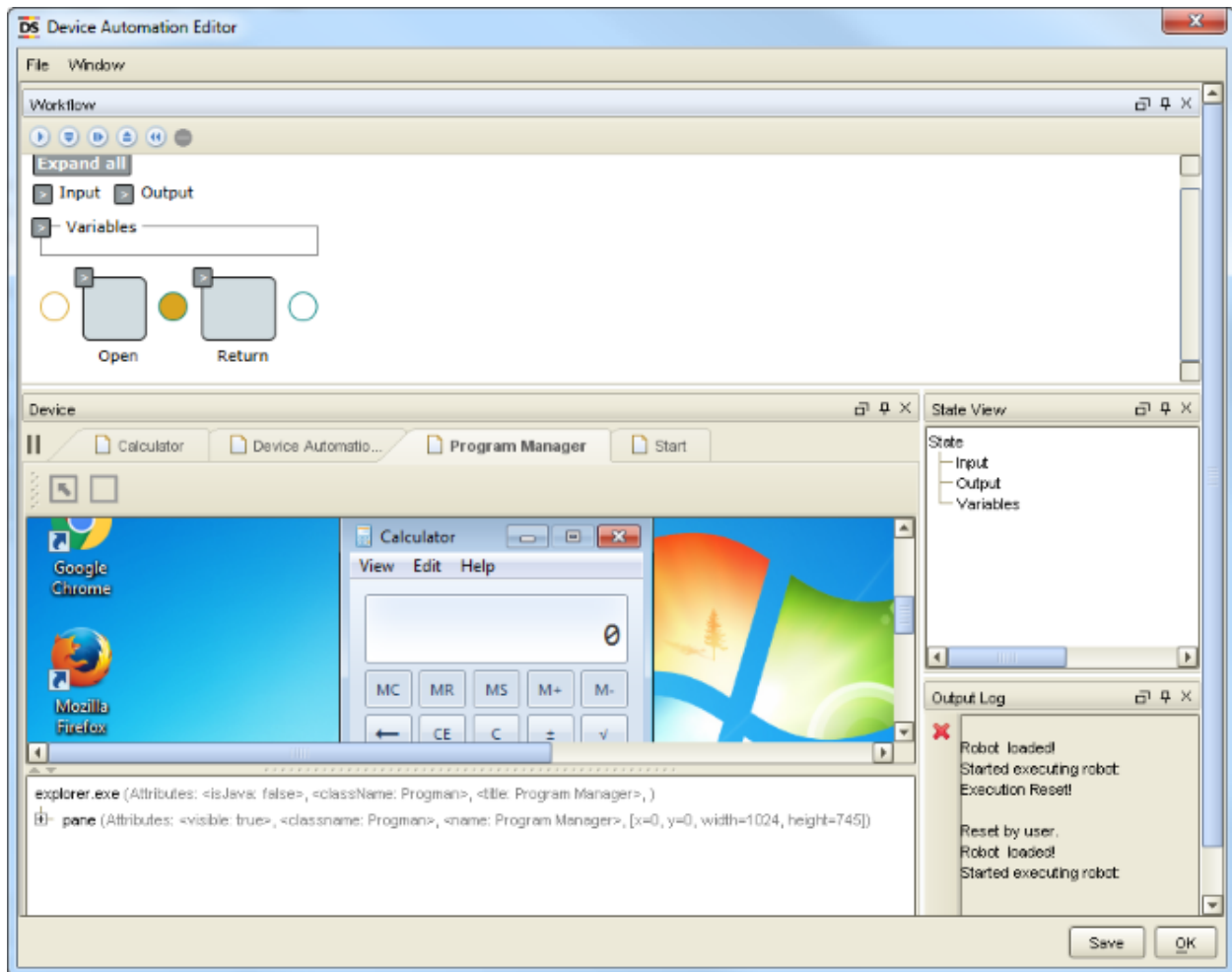

- **Workflow:** Contains a workflow of robot steps as well as variables and expressions. Buttons at the top of this window help you navigate the steps of the robot. You can go forward in the robot using the Run and Single Step buttons, you can pause the robot, or restart the entire robot.
- **Device:** Shows tabs with opened windows and a tree with available elements.
- **State View:** Shows state of the robot execution.
- **Output Log:** Contains robot execution messages.

Click  to open a step or other elements in the Workflow window.

Design Studio User Interface

This topic introduces the Design Studio user interface and begins the tour to the following elements (or others):

- [Menu bar](#)
- [Tool bar](#)

- [My Projects view](#)
- [Shared Projects view](#)
- [Databases view](#)
- [Editors view](#)
- [Robot Editor](#)
- [Type Editor](#)
- [Text Editor](#)

We recommend that you start the Design Studio to follow the user interface tour. Note, however, that the tour explores the Design Studio user interface as it appears at startup if you do not create or load a robot.

To view the Design Studio main window, you must have a valid, activated license. See the *Kapow Installation Guide* for details on licensing.

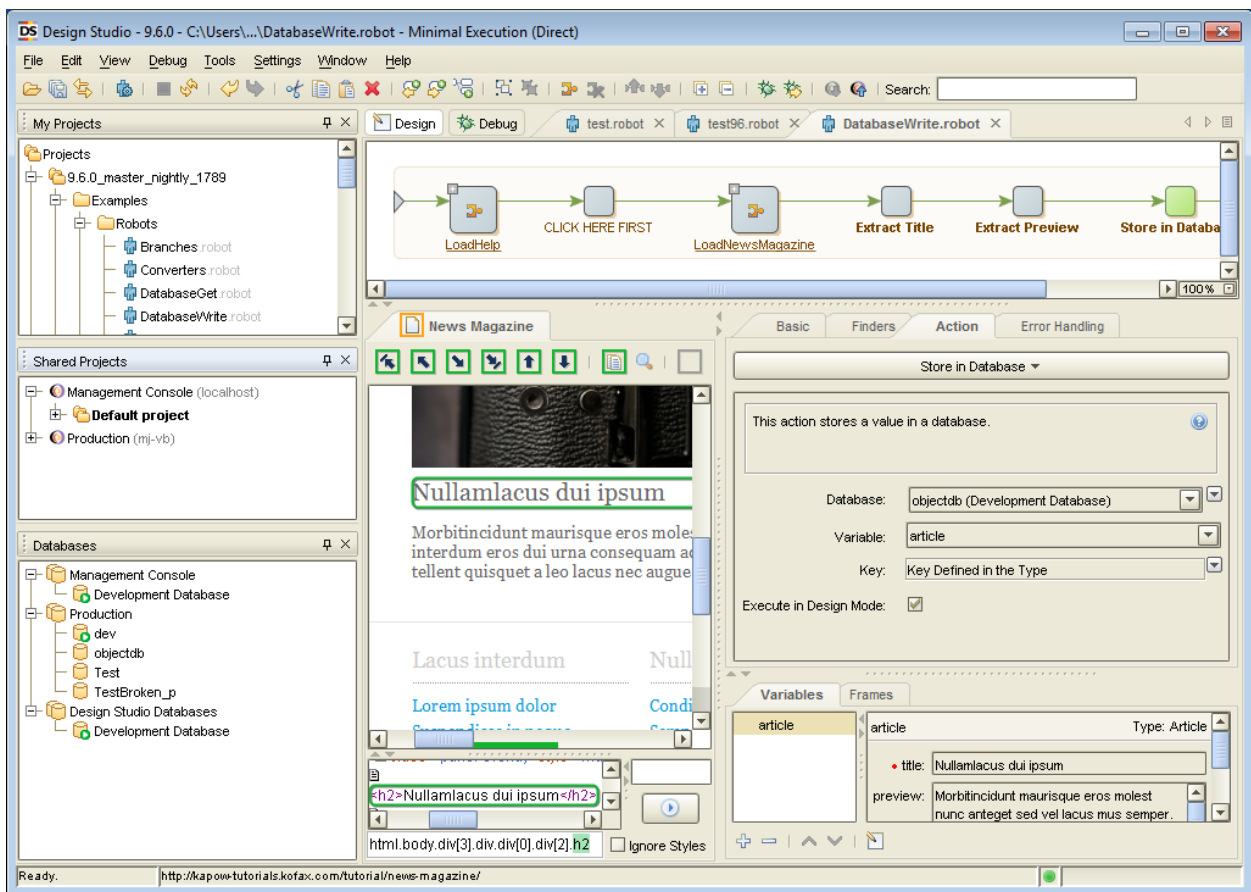

Menu Bar

The menu bar is located at the top of the Design Studio window.

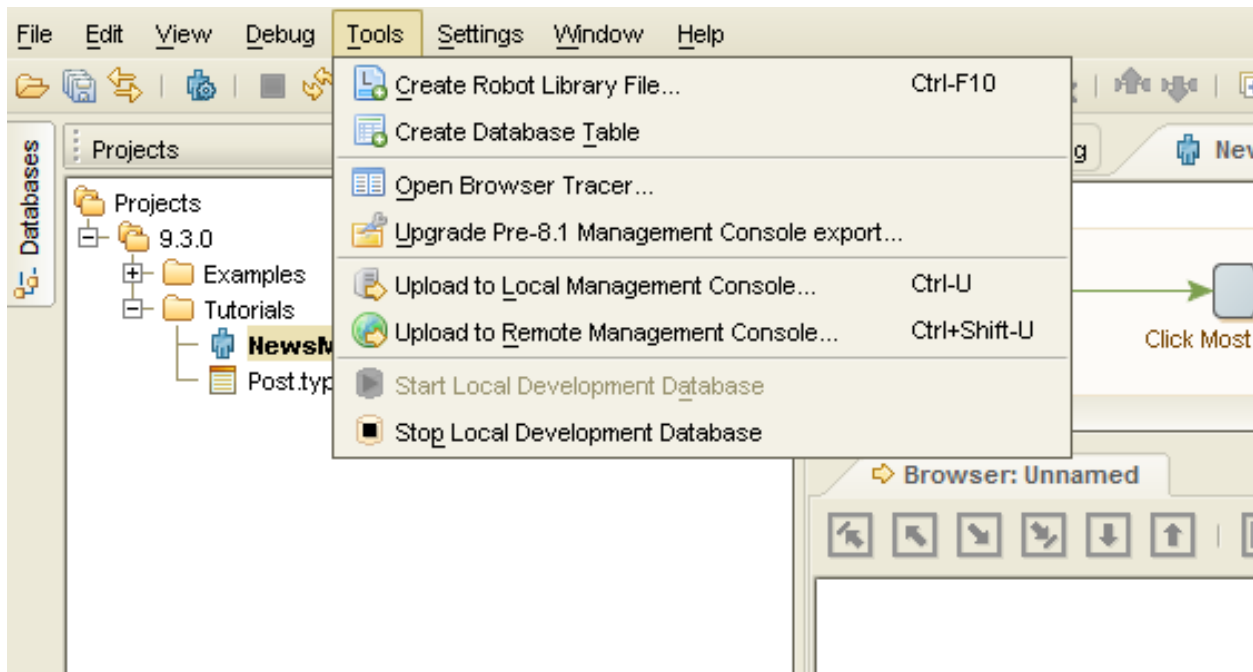

The available menus and included items are based on the type of file that is open in the Editor view. The following menus are always available even if no file is open (some items may be disabled):

- The File menu includes items for manipulating files, projects, and so on.
- The Options menu includes items for changing default settings and defining proxy servers or database connections.
- The Window menu includes items to change the layout of the user interface, such as Reset Layout.
- The Help menu includes links to the online reference help, documentation, and technical support information.

As soon as you open a file, such as a robot, the Edit menu is added to the available menus:

- The Edit menu offers a range of edit actions that you can perform on the opened file. The available actions depend on the type of the file, but it always contains the Undo and Redo actions.

If you open a type or a robot file, one more menu becomes available:

- The Tools menu lets you perform tasks related to the type of the file, such as generation of database table (for types), or deployment of robots to the Management Console (for robots).

If you open a robot file, three more menus may be available:











- The View menu lets you perform actions on the view or open additional views that are not open by default.
- The Debug menu contains actions related to the debugger.
- The Breakpoints menu contains actions related to the breakpoints in the debugger, such as adding and removing breakpoints. This menu is only available when the Robot Editor is in debug mode.













Toolbar





The Toolbar buttons let you perform many actions that are also available on the menus.



The available buttons change, depending on which editor is active in the Editors view.

Icon	Description
	Open Project
	Save All Files
	Configure Robot
	Synchronize All
	Stop - Escape
	Refresh
	Undo
	Redo
	Cut
	Copy

Icon	Description
	Paste Before
	Delete
	Insert step before selected step
	Insert step after selected step
	Add branch from selected step
	Group
	Ungroup
	Create snippet from selection
	Convert snippet to group
	Move step or connection up
	Move step or connection down
	Expand All

Icon	Description
	Collapse All
	Switch to Debug Mode
	Start Debug from current location
	Download robot from Management Console
	Upload robot to Management Console

My Projects View







The My Projects view is located under the toolbar icons in the Design Studio main window.

The My Projects view shows an expanding/collapsing tree structure representing the robot projects that are open in Design Studio. Click a + or - in this tree to expand or collapse the corresponding subtree. This view can contain as many opened robot projects as you like. In the My Projects view, you can right-click to open a context menu to perform various actions, such as creating a new robot in a folder, or opening a previously saved robot.

Shared Projects View

The Shared Projects view is located in the lefthand pane of the Design Studio main window under the [My Projects](#) view. You can rearrange the views by dragging them to different locations.

The Shared Projects view shows an expanding/collapsing tree structure representing the robot projects for the Management Consoles that you are connected to. If any projects in the Shared Projects view are shared with the Design Studio on your computer, both project views will contain those projects. Depending on the status of the files in the shared project, downloaded, updated, and deleted files have a different appearance. You can [synchronize](#) your local project with the Management Console project using different strategies. The following table shows project files with different statuses. The Shared Projects view also provides tips and explain synchronization problems.

Icon	Description	Meaning
 SimpleExtract.robot	Dimmed robot icon and name	An object in a shared project exists on the connected Management Console, but has not been downloaded to your Design Studio.
 LoadHelp2.snippet :	Normal icon and object name	An object in a shared project is in sync with remote Management Console.
 JSON.robot	Normal icon with object name crossed out	The object is deleted in the project on your computer.
 Extracting .robot	Normal icon with name in bold	The file has been changed locally and needs to be synchronized.
 JSONTest .robot	Icon with a plus sign and name in bold	A new file in your local project is not yet uploaded to the Management Console.
 Article.type	Object icon has a yellow sign with an exclamation mark	Conflict exists between your local copy and remote project. For example, the object was deleted on a remote Management Console. When synchronizing, select how to resolve the conflict.

Databases View

The Databases view shows databases for Design Studio and any connected Management Console.

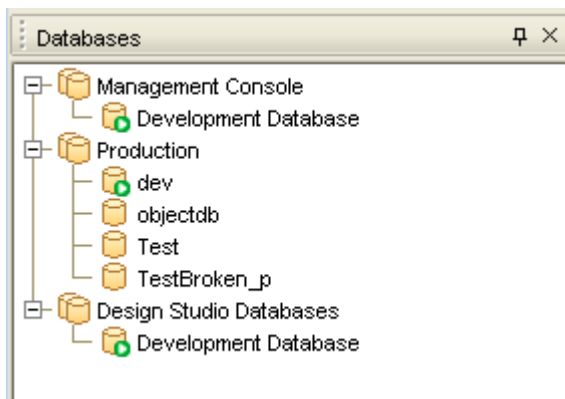

To configure connections to the Management Console, navigate to **Settings > Design Studio Settings > Management consoles**

The databases are fetched via [database mappings](#) in the Management Console. To have the databases displayed in the Design Studio Databases view, database mappings must exist for the cluster databases you want to share with Design Studio users. Unmapped cluster databases are not displayed in Design Studio.

Important The database mappings, types, and drivers are fetched from a Management Console only when the connection between the Management Console and you copy of Design Studio is established or refreshed during the following events:

- Adding a Management Console connection to Design Studio
- Starting Design Studio with an existing Management Console connection
- Refreshing the Management Console connection (to refresh, select the Management Console node in the Databases view tree and click **Refresh**).

Editors View

Use the Editors view to edit your robots and types. You can have many editors open at the same time, but only one editor is shown. The editors are shown as tabs at the top of the Editors view and you can click a tab to switch to another editor. There are three kinds of editors:

- The Robot Editor in which you edit a robot.
- The Type Editor in which you edit a complex type containing one or more attributes.
- The Text Editor in which you edit a plain text file.

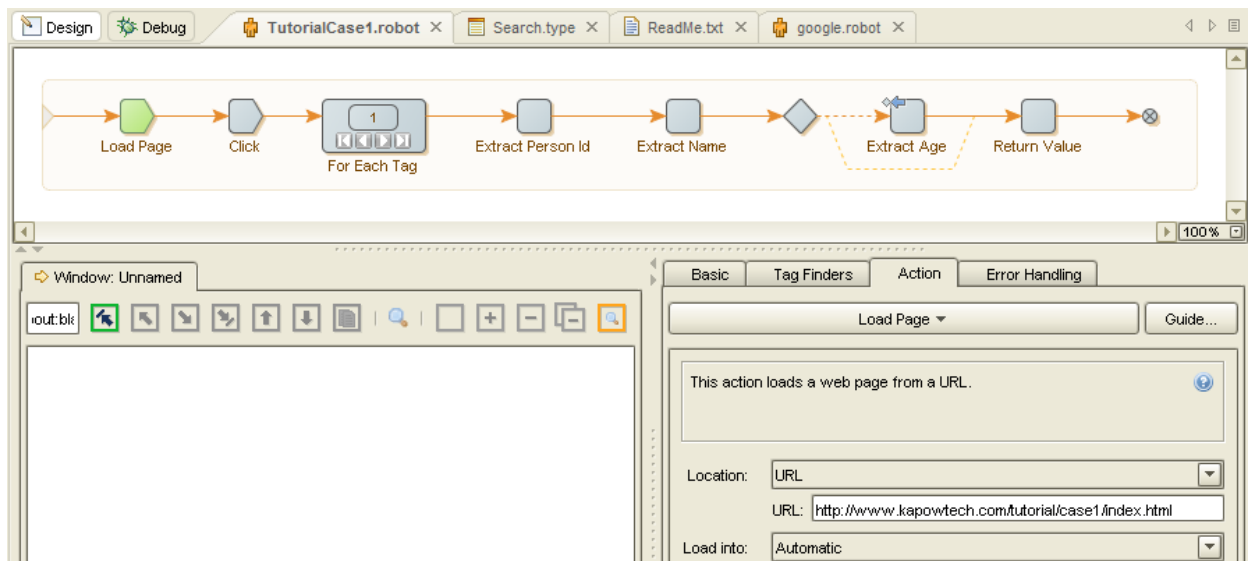

Robot Editor

Use the Robot Editor to edit robots. When you open a robot, it appears in a new Robot Editor placed in a new tab on the Editors view. The Robot Editor has two modes: design (default mode) and debug. Select a mode by clicking a mode button in the left corner of the Robot Editor. Depending on which mode you select, the appearance and availability of options may vary.

Each view consists of several subviews. For the design mode these are the following:

- [Robot View](#)
- [Windows View](#)
- [Step View](#)
- [Variables View](#)
- [Frames View](#)

Robot View

The Robot View is located at the top of the Robot Editor under the tabs. The Robot view shows you the robot program: the steps and connections that make up the robot. In this view you navigate the robot steps. Select a step to edit its structure such as delete, move, or connect steps.

Current Step

In the Robot View there is a notion called a "current step". The basic idea is that the partial robot that you are building is actually executed while you are building it. The current step marks the position in this execution and the Studio shows the state in the Page view and the Variables view.

The current step is marked in green. Click a step to execute the robot up to that step. The selected step becomes the current step. While the robot is executing, the step you clicked is shown in yellow. When execution reaches the step, it becomes the new current step and appears in green. If execution cannot reach the clicked step (for example, an HTML page does not load), the execution stops at the valid step, which becomes the new current step. If you click a step the robot has already executed, no execution occurs, but the new step becomes the new current step. You always configure the current step in the Step view.

Current Execution Path

The Current Execution Path is the path in the robot that the execution performed to get to the current step. The robot continues on this path until it reaches a branch or an end node. The current execution path is marked by a darker color on the connections. You can change the current execution path by clicking a connection, which will result in the connection being included in the path.

Select Items

To select a series of steps or connections, press and hold the Ctrl key and click the items. You can also hold down the left mouse button and drag it over the steps to select. Click anywhere outside the robot to deselect currently selected steps and connections.

When steps or connections are selected, you can apply actions to them. For example, to insert a new step, select a step and click the Insert Step After  on the toolbar. You can also right-click a step or connection to select an action from a list.

Note When you right-click a step or connection, it is automatically selected.

Edit Actions

The Robot Editor lets you perform a long range of actions on steps and connections. These include standard editor actions such as copy, paste, cut and delete, and actions that affect the execution of the robot in the design view, such as changing the iteration of a loop. You can perform actions on either the current step (if no other step is selected), selected steps or selected connections. Perform an action by clicking the corresponding toolbar button or by using the context menus on the selected elements.

You can configure another step by selecting it (by Ctrl-clicking it or dragging a selection box around it) and pressing the F2 key or selecting **Configure Step** on the context menu.

For more information, see [General Editing](#).

Windows View

The Windows view is located under the Robot view in the Robot Editor. In the Windows view, you can see a part of the current robot state: the part of the robot state that has to do with loaded pages. The state shown is the input state to the current step.

In the Windows view, you see the Page views of the windows in the current robot state. When loading from a URL, several windows may be opened, each containing a page. The current window is marked with an arrow. If the opened page contains non-HTML content, you can preview the page depending on the type of the content. Use the Preview button to change the type of the content. You can preview CSV, JSON, text, Excel, XML, and binary content and apply step actions to them.

If you use the Classic browser engine, for each window, the Page view is split into several sub views depending on the type of the page. For example, if the loaded page is an HTML page, the Page view has sub views. There are five types of pages: HTML, XML, JSON, Excel and Binary. HTML and Binary use the same view and the other page types use their own specialized Page views.

Note To view XML content with the applied XSLT transformation in the windows view, select **Configure Robot > Default Options: Configure > Legacy tab > Format Handling: Classic loading** and clear the **Convert XML to HTML** option.

To see the Cookies view of the state of the current step, you can open the Cookies window from the View menu. Cookies are added to this list as the robot loads web pages that use cookies.

Similarly, you can open the Authentications window from the View menu to see the authentications of the current state.

Step View

The Step View shows the configuration of the current step. Click the tabs to view and edit the following properties:

- **Basic:** Includes the name of the step and any associated comments. Steps with an attached comment are shown with a name in bold in the Robot View. You can rest the mouse pointer on a step to view the comment.
- **Finders:** View and configure the list of finders of the step. You normally configure the finders by right-clicking an element in the Page view. See [Using the Tag Finders](#).
- **Action:** View and configure the action for the step. For a description of the available actions, see [Step Actions and Data Converters](#).
- **Error Handling:** See how the current step handles errors. See [Handling Errors](#).

Variables View

The Variables View includes a list of variables. When you select a variable from the list, the associated details appear on the righthand side of the view. The view shows the variable values for the current step of robot execution, and cannot be edited.

- Right-click the variables list to access a list of variable types. You can add or remove variable types using this list. You can also remove the selected variable using this list.
- Click **Edit** to modify the initial variable values, or double-click an item in the variable list. A variable view similar to the Variables View window appears. This window displays the values of the variables before any step has been executed, and you can edit them.

When writing and testing a robot, you use initial input variable values. When a robot runs in production, the input variables are initialized to values determined by the application running the robot.

Note If the application does not provide values, the robot run will fail.

Initial values for variables are the values that they have at the start of the robot (for example, at the first step). The values apply when you are writing, testing, and running the robot in production.

Frames View

The *Frame* view is located next to the *Variables* tab at the bottom right corner of Design Studio.

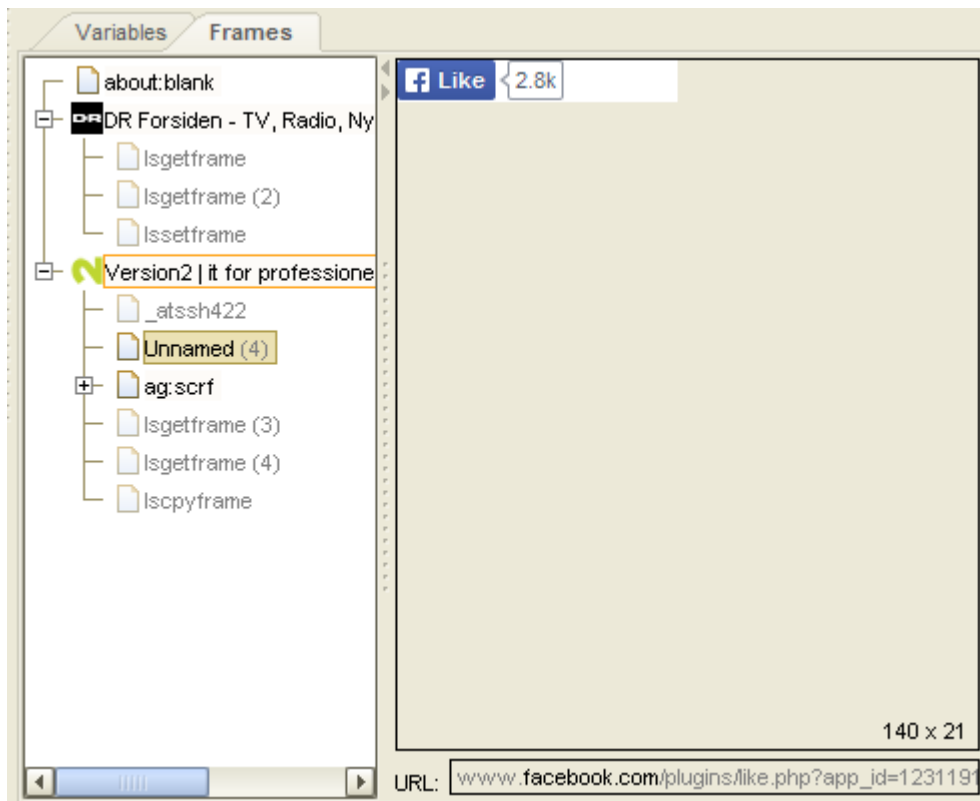

The Frames tab shows all top-level browser frames and all their sub-frames in a tree. The view also contains a preview panel showing details about the selected frame. Starting from Design Studio version 9.6, the Frames view is the only place to get an overview of the frames. The labels of the top-level frames in the Frames tree are the same as the tab titles in the Page view. If the HTML page shown in the frame has a title, it is shown, otherwise the URL is shown. The labels of sub-frames are shown by their names (Unnamed (n) if they have no name).

A node in the Frames tree may have various decorations such as:

- An orange box around a label: the frame is the current window.
- A gray box around a label: the frame is currently selected in the page view.
- Light gray background color around the label: the frame is open in the page view.
- The label and the icon is dimmed: the frame has no view (its viewport is zero height or zero width).

The *Frames Preview* panel next to the *Frames* tree shows details about the selected in the tree frame. The details shown are the URL and a small rendering of the browser view of the frame with an overlay showing the size of the frame, for example 1263 x 1024. If a frame is blocked by URL blocking, then this is shown with  both in the preview and in the tree.

Note The *Frames Preview* panel is only available for robots designed with the Default browser engine.



Frame View Actions

There are a number of actions associated with the nodes of the frame tree.

- **Set as Current Window:** inserts a "Set Current Window" step into the robot which is configured to open the frame with the name of the selected node (the name is shown in the tooltip on the node).
- **Close Window:** inserts a step in the robot to close the frame
- **Open/Close:** opens or closes a frame in the page view (a tab). Only works on non-toplevel frames since the top-level frames are always open. Note that this command does not insert any step into the robot.
- **Block URL:** opens a dialog box for editing a URL blocking pattern for the frame and add this pattern to the robot's list of Blocked URL Patterns
- **Select in Browser View:** selects the frame element in the browser view that defined the frame. If the frame containing the element is not open in the *Page* view, then this frame is opened.

Note These actions are also available on the browser view tabs of the page view.

Debug Mode

The Robot Editor contains a specialized mode for debugging robots. Click Debug  or Design  on the toolbar to switch between design and debug modes. This is also available on the Design Studio Main Window toolbar. Alternatively, to debug from the current step in Design Studio, click Debug.

The top of the Robot Editor in debug mode also contains a Robot view, similar to that of the design mode.

Note The Robot View in debug mode has a current step only when you are actually debugging the robot. This current step is not always the same as the current step in the Robot View in the design mode.

In the main panel, you see the results of the debugging process divided into various tabs.

- **Input/Output:** List of all used variables and all values returned during debugging.
- **API Exceptions:** List of API exceptions reported during debugging.
- **Log:** The processing log generated during debugging. Some actions, particularly those that take a while to execute, such as the Loop Form action, write status information to this log. Step errors are also logged if configured to do so.
- **State:** Whenever the debugging process is temporarily stopped, the State tab shows the robot state that is input to the current step. The State tab contains several sub-tabs.
 - **Variables:** Lists the variables.
 - **Window, Cookies, and Authentication:** Shows the state with associated dialogs.
 - **Local Storage and Session Storage:** Shows the HTML5 objects that have persisted locally.
 - **API Exception:** Generated at the current step. For all API Exceptions (and related errors), you can click the  Goto button to navigate to the step that generated the error. The step that generated the error becomes the current step in Design Studio.
- **Summary:** An overview of the number of variables returned or written to a database and generated API exceptions so far during the debugging process.
- **Stop When:** Specify the criteria required to temporarily stop the debugging process.
- **Steps to Skip:** Select steps to skip such as Store in Database, Delete from Database, Execute SQL, Execute Command Line, or Send Email.

For details, see [Debugging Robots](#).

Type Editor

Use the main window to configure the currently edited type. Among other things, you can configure the attributes of the type in the Attribute table. You can add new attributes, remove attributes, change their order, and configure attributes using the buttons below the Attribute table.

Text Editor

The Text Editor is a simple editor for plain text files (.txt) such as Readme files. The allowed extensions that the editor can open are .txt, .java, .jsp, .js, .log, .html, .xml, and .csv. The editor does not use the information that these extensions imply about file content. All files are treated as plain text files (no syntax highlighting).

General Editing

This topic gives a few general hints related to editing robots in Design Studio. These hints apply to when you make changes to a robot in the Step View, to a type in the Type Editor or to a text in the Text Editor.

Copy, Paste, or Cut

Use keyboard shortcuts to cut, copy, and paste items In Design Studio.

- **Ctrl-C** Copy
- **Ctrl-V** Paste

- **Ctrl-X Cut**

In addition, in most lists, such as the list of finders for a step, you can use **Ctrl-Shift-C** to copy all items in the list.

Group and Ungroup Steps

To group steps, select multiple steps and click Group  on the toolbar. You can also right-click a step and select from the list.

Some selections cannot be grouped. A group step must have exactly one ingoing connection and exactly one outgoing connection, and this must also hold for the selection of steps that you want to group. The only exception is when a selection of steps does not have any outgoing connection. In this case, you can group the selection, but the topmost End step must be connected to the end of the group. Take a look at the following example.

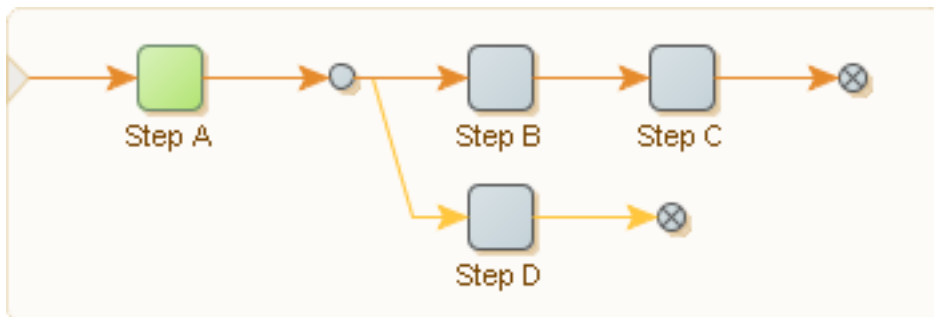

In this robot, the following are examples of steps you can group:

- All the steps
- Any single action step alone, such as Step A, Step B, etc.
- The branch point, step B, step C and the end step after step C



The following are some examples of steps you cannot group:



- the branch point and Step B (more than one outgoing connection)
- steps B, C, D and the two End steps (more than one ingoing connection)

You can select an expanded group step by either clicking (while holding down the Ctrl key) close to the connection or by including it in a drag selection.

To ungroup a step or collection of steps, select the items to ungroup and click Ungroup  on the toolbar, or from the context menu on the steps.

Note The Group and Ungroup actions are inverse. If you group a selection of steps and immediately ungroup them again, the structure of the robot is unchanged.

Use expand  and collapse  from the toolbar to perform the action on all groups.

Use expand  and collapse  from the context menu to perform the action on the selected group or groups.

The Expand and Collapse options on the context menu on steps do the same, but they are restricted to the Group steps in the selection.

Drag and Drop

In addition to actions, you can edit robot elements directly using drag and drop. As soon as you drag a step, special indicators appear showing valid drop locations. You can also select and move multiple steps at one time.

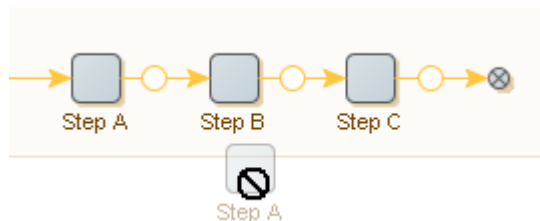

- To move a connection endpoint, select the connection and move the mouse to one of the handles at the end. Next, click the handle and move it to a new location. As soon as you click a handle, special indicators appear, showing where you may connect it.
- To abort a drag and drop action, move the mouse outside the robot and let go of the mouse button as shown in the following figure.



Add a New Connection

You can also create new connections using the mouse. Place the cursor near the end of a step so that an indicator appears (an orange circle with a green halo). Click the indicator and a new arrow appears. Keep the left mouse button pressed; move the mouse and a new connection will follow your mouse when you move it. New indicators appear and you can move the mouse to drop the new connection end point by releasing the left mouse button.

Undo and Redo Changes

While editing a robot, you can undo and redo every action. Click  or select Ctrl-Z to undo an action. Similarly, click  or select Ctrl-Y to redo an action.

Step Validation

As you edit your robot, the Robot View validates each step. Invalid steps are underlined in red. You can move the mouse to an invalid step to view an explanation of error.

Types

Write and maintain Types to define parameters used in a robot.

It is important that you configure all of the relevant properties. Otherwise, the type may not perform as expected, or it may be invalid.

Types must have:

- A valid name. Type names must begin with a letter or an underscore and can only contain letters, digits, and underscores.

Note In Design Studio, the name does not include an extension. For example, a type with the file name ExampleType.type is available in Design Studio as ExampleType. For more information about naming, see [Naming policy](#).

- A unique name. Two types in the same project must not have the same name.
- A type kind which indicates how the type will be used.

You can select the type kind using the "Type kind" drop-down list below the Attribute Table. Normally, it is not necessary to select anything as the type kind "Standard Type" is always used unless you need the legacy type kind "Database Output Type." See [the reference documentation on Design Studio](#) for more information.

Type Attributes

The attributes within a type must also be correctly added and configured in order for the type to be valid. You must specify both a name and a type for each attribute. The available attribute types are listed in the following table.

Attribute Type	Description
Integer	An integer, such as 12. The possible range is from -9223372036854775808 to 9223372036854775807, both inclusive.
Number	A number, such as 12.345. The possible range is from $\pm 2.2 \times 10^{-308}$ to $\pm 1.8 \times 10^{308}$ with slightly more than 15 digits of accuracy.
Boolean	A boolean value; either "true" or "false".
Character	A single character, such as "A".
Short Text	A short text. Displayed in a one-line text field.
Long Text	A long text. Displayed in a multi-line text box.
Password	A password. Displayed in a password field that shows asterisks instead of the characters in the password.
HTML	An HTML clip. This is the same as a Long Text, except that you can preview the clip in a browser window.
XML	An XML document. This is the same as a Long Text, except that only well-formed XML documents are allowed.
Date	A date, which must use the form yyyy-mm-dd hh:mm:ss.n, such as "1992-04-25 10:33:06.0".
Binary	Binary data; any sequence of bytes.
Image	An image. This is the same as Binary Data, except that you can preview the image.
PDF	A PDF document. This is the same as Binary Data, except that you can preview the PDF document.
Session	A session (containing cookies, authentications, etc.).
Currency	A currency code, as defined by the ISO-4217 standard, such as "EUR" for Euro.
Country	A country code, as defined by the ISO-3166 standard, such as "DE" for Germany.
Language	A language code, as defined by the ISO-639 standard, such as "de" for German.
JSON	A JSON value is either a JSON text or JSON Simple type where the JSON Simple type is either a JSON literal, a number, or a string.

Step Actions and Data Converters

In Design Studio, a short description is shown with each action and data converter. Click More next to the description to see additional information about the action or data converter associated with the description. You can also click help  to get onscreen assistance associated with a selected step action or data converter.

Several of the actions, such as Extract, can run extracted text through a list of data converters and sort the result in a variable.

A data converter processes extracted text based on parameters you define. For example, the Extract Number data converter accepts an input text containing a number and outputs a text containing the same number in a standardized format.

Because a data converter takes a text as input and outputs another text, data converters can be chained so that the output of one data converter becomes the input to the next data converter. The final output is the text output of the last data converter in the data converter list. For example, if the list of data converters contains the converter Convert to Upper Case, followed by a Remove Spaces data converter, the input text to the list is "R oboMa ker", is output as "ROBOMAKER".

Patterns

If you are new to patterns, we suggest you watch the [introduction video on patterns](#).

A pattern is a formal way of describing a text. For example, the text "32" can be described as a text containing two digits. However, other texts also contain two digits, such as "12" and "00" and can therefore also be described as a text containing two digits. We can express this by the pattern `\d\d` which is a formal way of expressing that a text must contain two and only two digits (`\d` is the symbol for a digit). We say that these texts match this pattern. Design Studio patterns follow the Perl5 syntax.

A pattern is composed of normal characters and special symbols. Each special symbol carries its own special meaning. For example, the special symbol "." (dot) means any single character and matches all single characters, such as "a", "b", "1", "2", ...

The table below provides an overview of the most commonly used special symbols.

Special symbol	Description
.	Any single character, such as "a", "1", "/", "?", ".", etc.
\d	Any decimal digit, such as "0", "1", ..., "9".
\D	Any non-digit, that is the same as ".", but excluding "0", "1", ..., "9".
\s	Any white space character, such as " " and line break.
\S	Any non-white space character, i.e. same as ".", but excluding white space (such as " " and line break).
\w	Any word (alphanumeric) character, such as "a", ..., "z", "A", ..., "Z", "0", ..., "9".

Special symbol	Description
\W	Any non-word (alphanumeric) character, i.e. same as ".", but excluding "a", ..., "z", "A", ..., "Z", "0", ..., "9".

Examples

- The pattern ".an" matches all text lengths of three ending with "an", such as "can" and "man" but not "mcan".
- The pattern "\d\d\s\d\d" matches all text lengths five starting with two digits followed by a white space and ending with two digits, such as "01 23" and "72 13" but not "01 2s".
- If you want a special character, such as "." or "\", to act as a normal character, you can escape it by adding a "\" (backslash) in front of it. If you wish to match exactly the "." character, instead of any single character, you should write "\.".

For example, the pattern "m\\.n\\o" only matches the text "m.n\\o".
- You can organize a pattern into subpatterns by the use of parentheses: "(" and ")".

For example, the pattern "abc" can be organized as "(a)(bc)".
- All single characters are considered subpatterns.

For example, in the pattern "abc", each single character "a", "b", and "c" is considered a subpattern.

Subpatterns are useful when applying pattern operators. The following table provides an overview of the available pattern operators.

Operator	Description
?	Matches the preceding subpattern, or the empty text.
*	Matches any number of repetitions of the preceding subpattern, or the empty text.
+	Matches one or more repetitions of the preceding subpattern.
{m}	Matches exactly m repetitions of the preceding subpattern.
{m,n}	Matches between m and n repetitions (inclusive) of the preceding subpattern.
{m,}	Matches m or more repetitions of the preceding subpattern.
a b	Matches whatever the expression a would match, or whatever the expression b would match.

Examples

- ".*" matches any text, such as "Design Studio", "1213" and "" (the empty text)
- "(abc)*" matches any number of repetitions of the text "abc", such as "", "abc", "abcabc", and "abcabcabc", but not "abca"
- "(\\d\\d){1,2}" matches either two or four digits, such as "12" and "6789", but not "123"
- "(good)?bye" matches "goodbye" and "bye"
- "(good)|(bye)" matches "good" and "bye"

As with other special characters, you can escape the special characters that appear in pattern operators by adding a "\" backslash in front of the character.

Subpatterns are useful when you want to extract specific text pieces from a text. When you make a subpattern using parentheses, you can extract the part of the text that is matched by that subpattern. For example, consider the pattern "abc (.*) def (.*) ghi". This pattern has two subpatterns that are made

by means of parentheses. If the pattern is matched against the text "abc 123 def 456 ghi", the first of those subpatterns will match the text "123", and the second subpattern will match the text "456". In an expression (see [Expressions](#)), you can refer to these subpattern matches by writing "\$1" and "\$2". For example, the expression "X" + \$1 + "Y" + \$2 + "Z" will produce the result "X123Y456Z". This is a very important extraction technique in Design Studio.

By default, the repetition pattern operators (*, +, {...}) will match as many repetitions of the preceding pattern as possible. You can put a "?" after the operator to turn it into an operator that matches as few repetitions as possible. For example, consider the pattern ".*(\d\d\d).*". If the pattern is matched against the text "abc 123 def 456 ghi", the subpattern "(\d\d\d)" will match the second number in the text ("456"), since the first *-operator will match as many repetitions as possible. If you put a "?" after the *-operator, so that the pattern becomes ".*?(\d\d\d).*", the subpattern "(\d\d\d)" will match the first number in the text ("123"), since the *?-operator will match as few repetitions as possible.

We recommend that you experiment with patterns on your own. The best way to do this is to launch Design Studio and find a place where you can enter a pattern, such as in the Test Tag action. Then, click the **Edit** button to the right of the pattern field, to open the following Pattern Editor window.

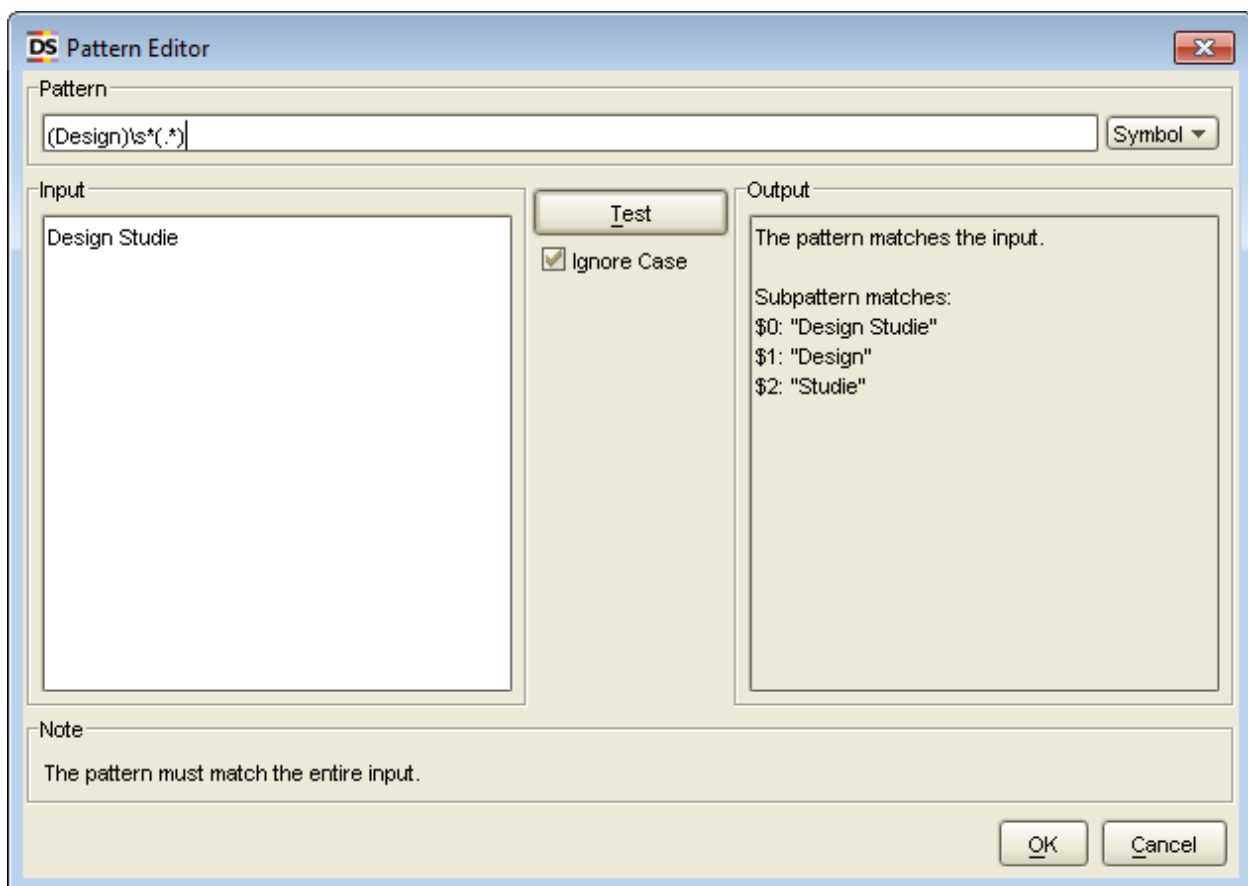

In the Pattern Editor you can enter a pattern and test whether it matches the test input text in the Input panel. When you open the window, Design Studio usually sets the test input text to the text that the pattern is matched against if the given step is executed on the current input robot state. However, you can

also edit the test input text yourself, to try the pattern on other inputs. To test the pattern, click the **Test** button. The result of the matching appears in the Output panel.

The Symbol button is very useful when you want to enter a special symbol in the pattern. When you click it, a menu is shown, from which you can select the symbol to insert in the pattern. This way, you don't have to memorize all the special symbols and their meanings.

For more on the available special symbols and patterns, refer to documentation on [Patterns](#).

Expressions

An expression typically evaluates to a text. For example, the expression

"The author of the book " + Book.title + " is " + Book.author + "." evaluates to the text "The author of the book Gone with the Wind is Margaret Mitchell.", if the variables Book.title and Book.author contain the texts "Gone with the Wind" and "Margaret Mitchell", respectively.

You can also do numeric calculations within the expression. For example, if the variable Book.price contains the price of a book, you can multiply it by 100 using the following expression:

```
Book.price * 100
```

The following table provides an overview of the most commonly used sub-expression types. For a complete overview of all available sub-expression types, see the [reference documentation on expressions](#).

Commonly Used Sub-Expression Types

Sub-Expression Type	Notation	Description
Text Constant	"text" or >>text<<	Evaluates to the specified text, e.g. "Margaret Mitchell", or >>Margaret Mitchell<<.
Variables	variablename.attributename	Evaluates to the value of the specified variable, e.g. "Book.author" might evaluate to "Margaret Mitchell".
Current URL	URL	Evaluates to the URL of the current page.
Subpattern Match	\$n	Evaluates to the text matched by subpattern in an associated pattern (if any). For example, this is used in the Advanced Extract data converter, as shown below. \$0 evaluates to the text matched by the entire pattern.
Function	func(args)	Evaluates the specified function by passing it the specified arguments and converting its result to a text.

Note that you can specify a text constant using either the quote notation or the >>text<< notation, for example "Margaret Mitchell" or >>Margaret Mitchell<<. If you use the quote notation, and you want a quote character to appear inside the text, you have to write it as two quote characters. For example, write "This is some ""quoted"" text" to get the text "This is some "quoted" text". If you use the >>text<< notation, anything can appear inside the text, except ">>" and "<<". Thus, you can write quotes directly,

as in >>This is some "quoted" text<<. The >>text<< notation is useful for long texts that contain many quote characters, such as HTML.

The following table shows the most commonly used functions in expressions.

Function	Description
toLowerCase(arg)	Converts the argument to lowercase.
round(arg)	Rounds the argument to the nearest integer.

For example, the expression "The discount is " + round((Item.oldPrice - Item.newPrice) / Item.oldPrice) + "%." evaluates to "The discount is 10%." when the item's old price is \$99.95 and the new price is \$89.95.

Experiment with Expressions

We recommend that you experiment with expressions on your own. The best way to experiment with expressions is to launch Design Studio and open an existing robot.

1. In Design Studio, select the **Extract** action for the current step.
2. Add an Advanced Extract data converter.
3. Click the Configuration  icon to configure the data converter.
The Advanced Extract Configuration Window appears.

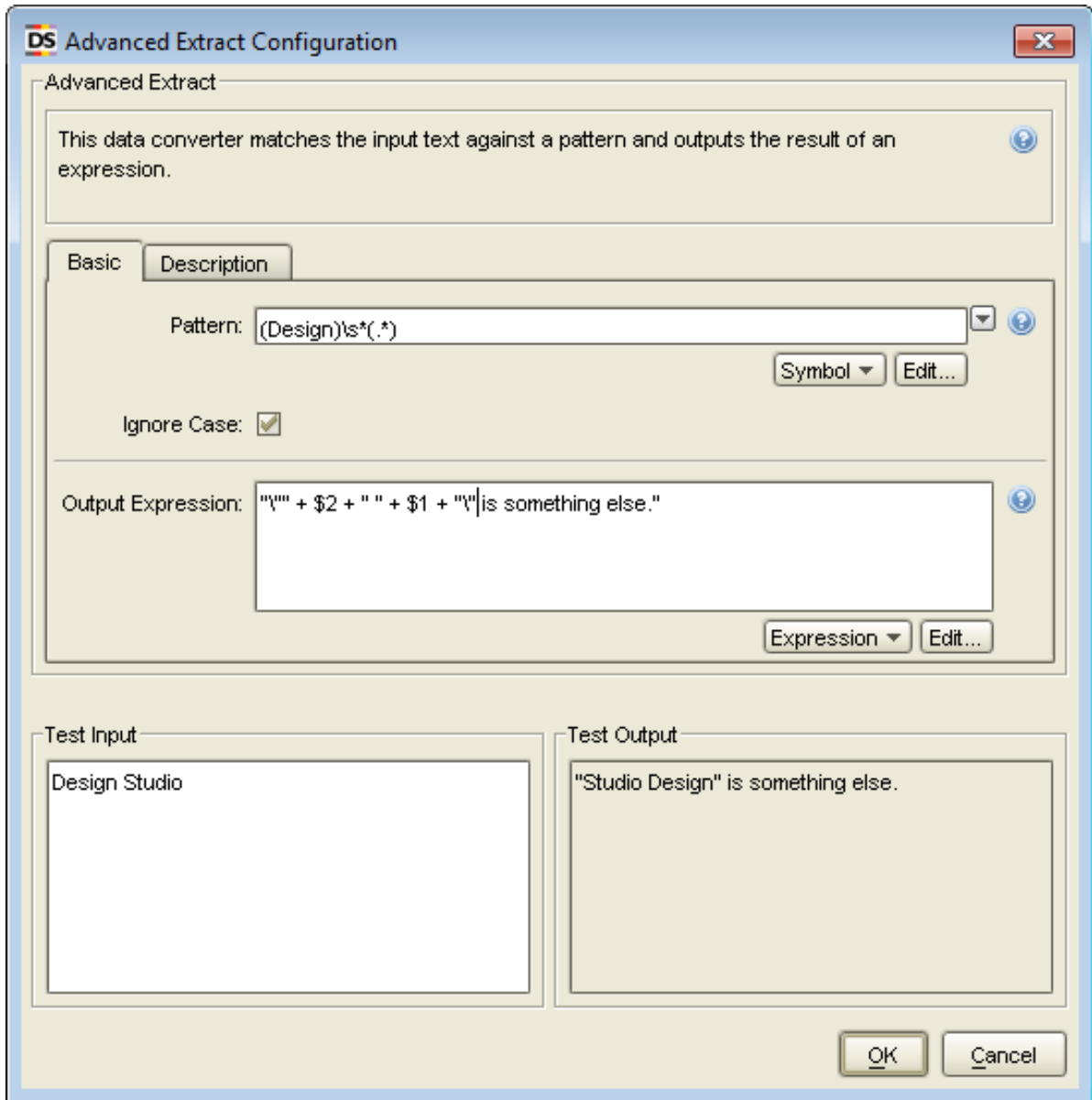

In the shown example, note the use of the \$n notation to extract parts of the input text.

4. Change the input text in the text area to the left.
5. Next, change the Pattern property.
6. Change the Output Expression property.
Review the results in the right area, while typing the expression.

Edit Expressions

1. On the Advanced Extract Configuration window, in the Output Expression field, click **Edit**.

The Expression Editor appears.

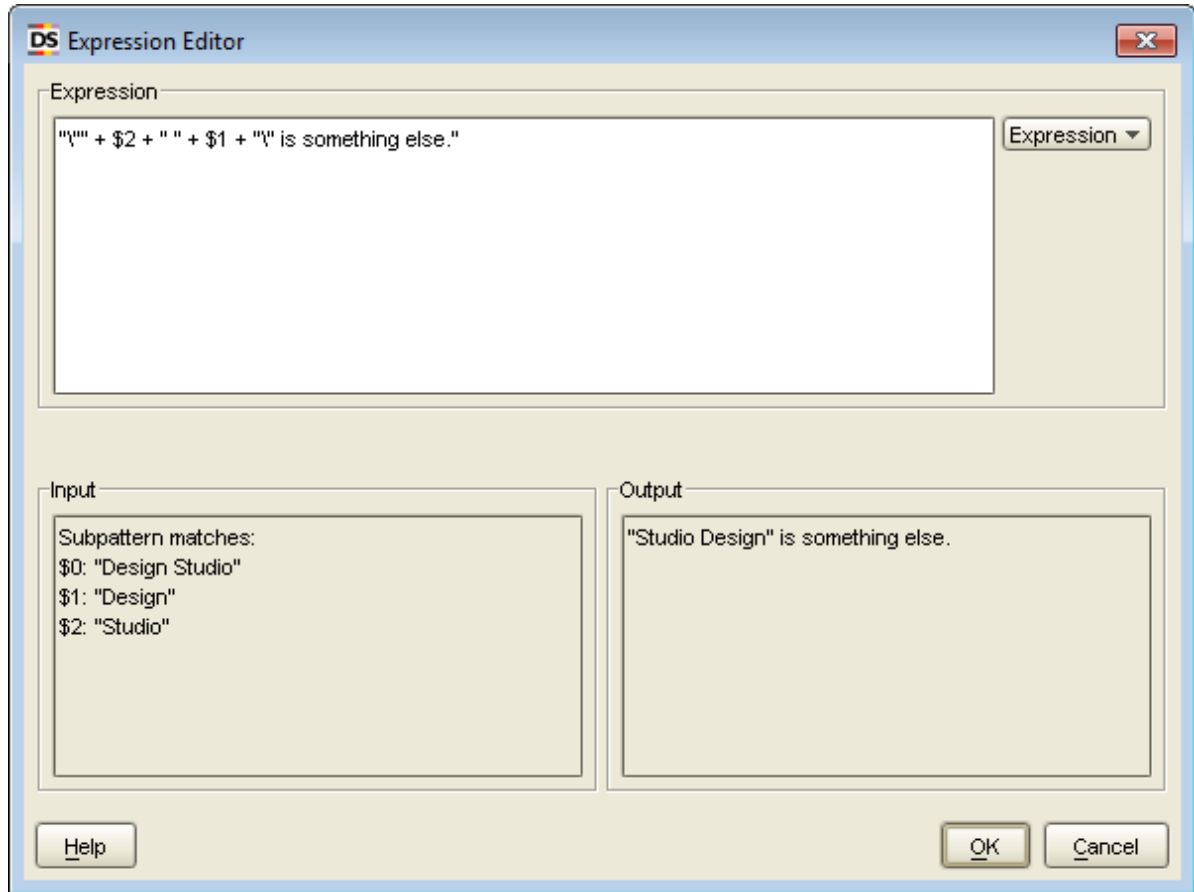

2. In the Expression field, enter an expression, or click **Expression** to select one from the list. Options include Constant, Variables, Operators, Special Character, Functions, Page Properties, and Robot Properties with additional sub-expression functions. Expression values appear in the Input and Output sections.

Note Testing functionality is not available everywhere in Design Studio.

3. Click **OK**.

Projects and Libraries

When working in Design Studio, you can have any number of projects open at any time. The purpose of a project is to develop a library containing a collection of robots and the files required by these robots. Typically, you create a project for each separate usage of robots, such as one project for each application in your company that uses robots. Two projects cannot share files; a type always belongs to one project, and the scope of a type is the project it belongs to.

A project is a folder located anywhere in the file system. The project folder can have any name you want, but must contain the Library sub-folder.

Note See [Naming policy](#) for more information about naming.

Library

This folder contains the library of the project.

Place all robot files, type files, and other files used by the robots, such as files that are loaded from the robot library in the Library folder. You can organize the files in the Library folder using subfolders as appropriate.

The following example shows a project folder named NewsAndStocksProject for a project that develops a robot library for extracting news from news sites and stock quotes from stock sites.

```
NewsAndStocksProject/  
  Library/  
    News/  
      CNN.robot  
      Reuters.robot  
      News.type  
    Stocks/  
      Nasdaq.robot  
      NYSE.robot  
      Stocks.type
```

Note that this project has a Library folder with robot and type files divided into News and Stocks subfolders.

When you close Design Studio, it remembers the projects and files open. The next time you open Design Studio, it will open the same projects and files.

Current Project

In Design Studio you can work with many projects, but the other applications in Kapow, such as RoboServer, always work on a specific project, referred to as the current project. When you install Kapow, a default project is created. This project is selected as current. If you open Design Studio the first time, this current project is the only opened project. If you close all projects before you close Design Studio, the next time you open Design Studio it opens the selected current project.

You can change the current project selection using the Settings application, specifying the path to your new project folder in the Current Project Folder property in the Project tab, and then clicking OK to close Settings. Please see the *Kapow Developer's Guide* for more information.

Shared Project

Shared project is a project that is deployed on a Management Console and connected to a project on your local Design Studio computer. Management Console project can be shared between several Design Studios, thus several people can edit a project. When your shared project is out of sync with the project on the Management Console, the [Shared Projects View](#) visualizes the status of each object in the project. You can use different strategies when [synchronizing](#) your local copy with one deployed on the Management Console.

Manipulate Robot Projects

Use the following procedures to open, close, and create projects.

- To open an existing project, on the File menu, select **Open Project** and select a project folder. The Open Project window appears.
- To close a project, in the My Projects view, right-click the project. The Project window appears. Click **Close**.

You can also close all projects from the File menu.

- To create a new project, do the following:

1. On the File menu, select **New Project**.
The New Project window appears.
2. Enter the name and location for the project.
3. Click **Finish**.

A new project is created in the location you specified. The project folder name is the same name you assigned to the project.

Example

If you entered the name MyProject and the location: C:/KapowProjects then the following folders are created:

C:/KapowProjects/MyProject

C:/KapowProjects/MyProject/Library

Organize Robot Files

When you want to distribute and deploy your robot library in a runtime environment, such as RoboServer, you can pack the robot library into a single file called a robot library file.

This will pack together all files contained in the robot library of the file in the current editor and save the result as a single file with a name that you assigned. Before creating the robot library file, save all open files, such as robots and types, to include the most current changes.

You can make the robot library file available to RoboServer and execute robots from the robot library. See the *Kapow Developer's Guide* for more information.

1. In Design Studio, save all open project files such as robots and types.
2. On the Tools menu, select **Create Robot Library File**.
The Select Robot Library Output File appears.
3. Navigate to the location to use for your library.
Use the icons on the toolbar to change to Details or List view, move up one level, or create a new folder.
4. In the File Name field, enter a name for the library.
5. Click **OK**.
The system creates the robot library file.

6. Click **OK**.

Work with Shared Projects

Once you [connect](#) to one or more Management Consoles, the [Shared Projects](#) view displays all projects deployed on all Management Consoles that you have access to. If projects and objects are not downloaded to your local computer, they are listed but not available. The Design Studio does not track such projects.

Uploading a Project to a Management Console

To upload a project to a Management Console, perform the following:

1. Right-click a project in the [My Projects View](#) and select **Upload** on the context menu; or select a project and click **Upload to Management Console** on the Tools menu.
2. Select the Management Console and project that the files will be uploaded to in the Upload to Management Console window.

Click **Remember this (as a shared project)** if you want to keep this project as shared and synchronize it between the Design Studio and the Management Console.

3. Click **Upload** to complete the procedure.

After you upload a project to the Management Console, the project appears in the [Admin > Projects](#) tab and all project files appear in the [Repository](#) tab of the selected Management Console.

Downloading a Project from a Management Console

To download a project from a Management Console, perform the following:



1. Right-click a project in the [Shared Projects View](#) and select **Download** on the context menu; or select a project and click **Download from Management Console** on the Tools menu.
2. Select the name for the project and its location in the Select Project Name and Location window.
3. Click **Finish** to download the project.

After you download a project from the Management Console, the project also appears in the [My Projects View](#) and you can edit the project files locally.

Synchronizing Projects

After you edit the files of the shared project on your computer, you can synchronize your local files with those deployed on the Management Console. Because a shared project can be accessed by several people, you might come across a synchronization conflict. The Design Studio provides messages and descriptions for you to understand what the conflict is, and how you can resolve it. Note that changed dependent files such as Types and Snippets can also prevent your robot from functioning properly. If you use Download to synchronize your project, the files are downloaded from the Management Console and your local changes are lost. If you use Upload, your local files are uploaded to the Management Console and any changes made by other people are lost (but those changes might as well be stored on their local computers). In any conflict situation, when changes made by you or other people can be lost, the Design Studio opens the Synchronize window for you to select the synchronization option.

The following table provides synchronization examples.

Status	Synchronization Option	Result
The shared project files have been edited on your computer. No others who have access to the same project on the Management Console edited the files.	 Upload	Your changes are uploaded to the shared project on the Management Console. If you select Synchronize, the default option is to upload your changes to the Management Console.
The shared project files are changed on the Management Console. You know who edited the files and what the changes are.	 Download	Changed files from the Management Console are downloaded to your local project.
You edited the shared project files on your computer. Someone else edited the files and uploaded them to the Management Console while you were editing the same files.	 Synchronize	This is a conflict situation and you need to decide which changes to keep. In the Synchronize window you can select to either upload your changes to the Management Console, download the files from the Management Console, or just keep your files without synchronizing them with the Management Console.

Interact with Databases

You can use Design Studio to interact with databases. For details, see the following topics.

- [Map Databases](#)
- [Types and Databases](#)
- [Database Warnings](#)
- [Create Database Tables](#)
- [Store Data in Databases](#)

Map Databases

Robots may need to access databases through various database accessing steps (such as Store In Database). You must provide a reference to a named database for these steps. The named databases used by a robot must be accessible from the RoboServers in order for the robot to be executed successfully on RoboServers.

While designing robots in Design Studio, it is convenient to use local databases that are not available from the RoboServers. Rather than having to remember to change the named databases on the various database accessing steps before deploying a robot, Design Studio has an extra layer of abstraction to help overcome this problem: the database mapping. The mapping mechanism maps a named database in a database access step of a robot to a Design Studio database. As long as the robot is executed from within Design Studio, the named databases of the database accessing steps are mapped to the Design Studio databases specified by the mappings. The Design Studio user can use local databases while

designing and testing robots without having to change the referenced named databases of the database accessing steps before deploying the robots.

Using database mappings also makes it easy for the Design Studio user to create the robot store values in a different database: it is a matter of reconfiguring the mapping to make it point to a different database.

A database mapping is a small configuration file defining which database to map to and whether Design Studio should display various warnings helping the user correctly configure the mapping and the referenced database. The name of the mapping is the file name of the configuration file. This means that if you create a mapping with the file name "objectdb," the database that the mapping points to will be accessible under the name "objectdb" in robots. Note that the databases may have the same names across different Management Consoles, to distinguish them when creating database mappings in Design Studio. A database name in the list includes a management console name as in the following example.

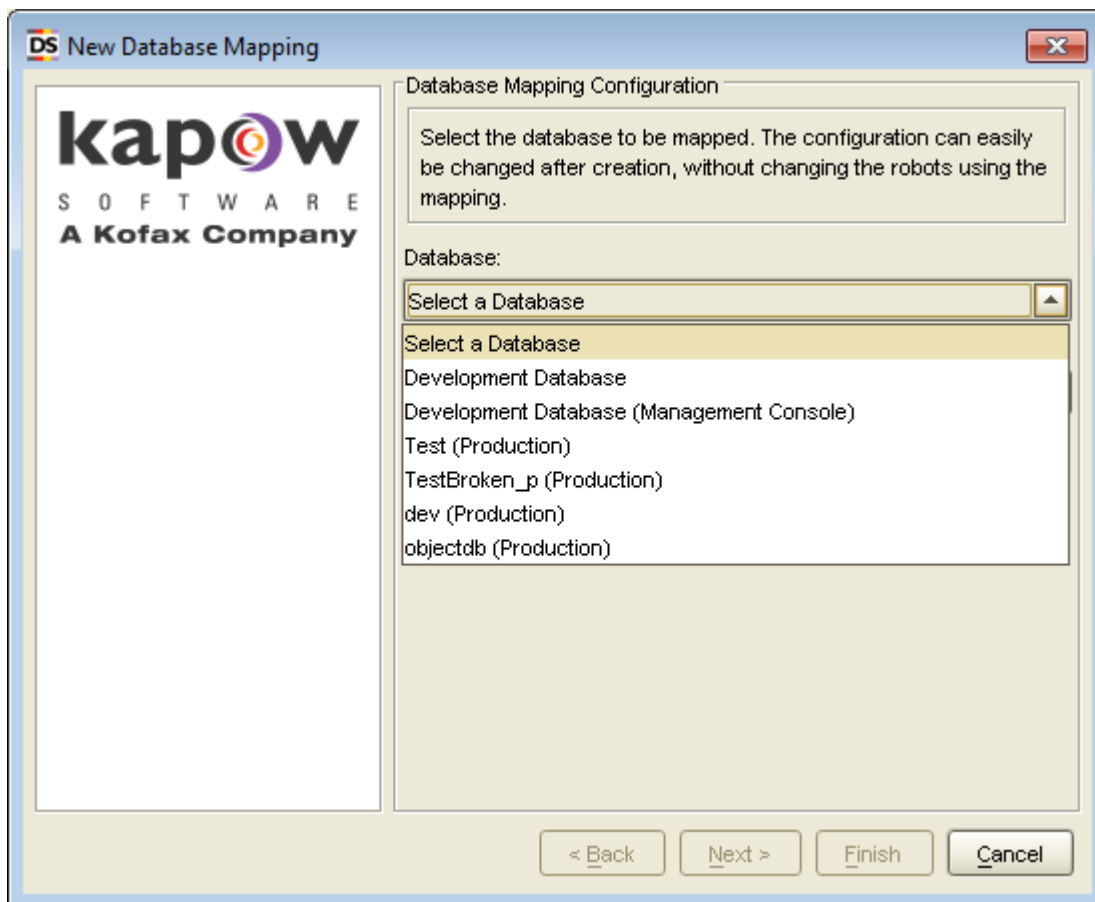

The following steps show several ways to create a database mapping in Design Studio.

1. On the File menu, select **New Database Mapping**.
A wizard appears.
2. Select a database and a project and click **Next**.
3. Enter a database mapping name and click **Finish**.

When the wizard is finished, the mapping is created in the selected project and folder and is usable by robots.

Database View

1. In the database view, right-click the database to associate with a project.
2. Select **Add to Project** and select the project to add the database to.
3. Enter the name to use for the database mapping. This is the mapping file name and the name the database will be accessible under.
Notice that a name is suggested. This is the default database name, and the name used to access this database in other Kapow applications apart from Design Studio.

Unmapped Database

In Design Studio, when you open a robot using a database you do not have a mapping for, a warning is displayed.

1. Open a robot using an unmapped database.
A warning appears, recommending a mapping with the name of the database referenced in the robot. This allows you to quickly run robots sent to you from developers who have other databases defined - without modifying the robots.
2. Complete the steps in the wizard.

Types and Databases

If your robot writes the values of variables to a database, the types of these variables need to define which attributes must be part of the key used to store the values in the database. The database key for the value is calculated as a secure hash of the attributes marked to be part of the database key.

You can also specify a storage name as part of your attribute definition. This is an optional different name to use when storing the attribute.

When saving values to database storage using the Store in Database action, the appropriate database table must exist in an available database. The table is required to contain columns matching the attributes of the type.

See [Creating and Deleting Database Tables](#) for more information on how Design Studio can assist you in setting up the appropriate database tables. Consult [Settings in Design Studio](#) for more information on setting up database connections in Design Studio.

Database Warnings

Database warnings help you configure the database mappings, the robots and the referenced databases correctly. The warning system automatically monitors for potential problems such as type validation issues, missing tables, or missing database mappings and if an issue arises, a warning message is displayed in a status bar.

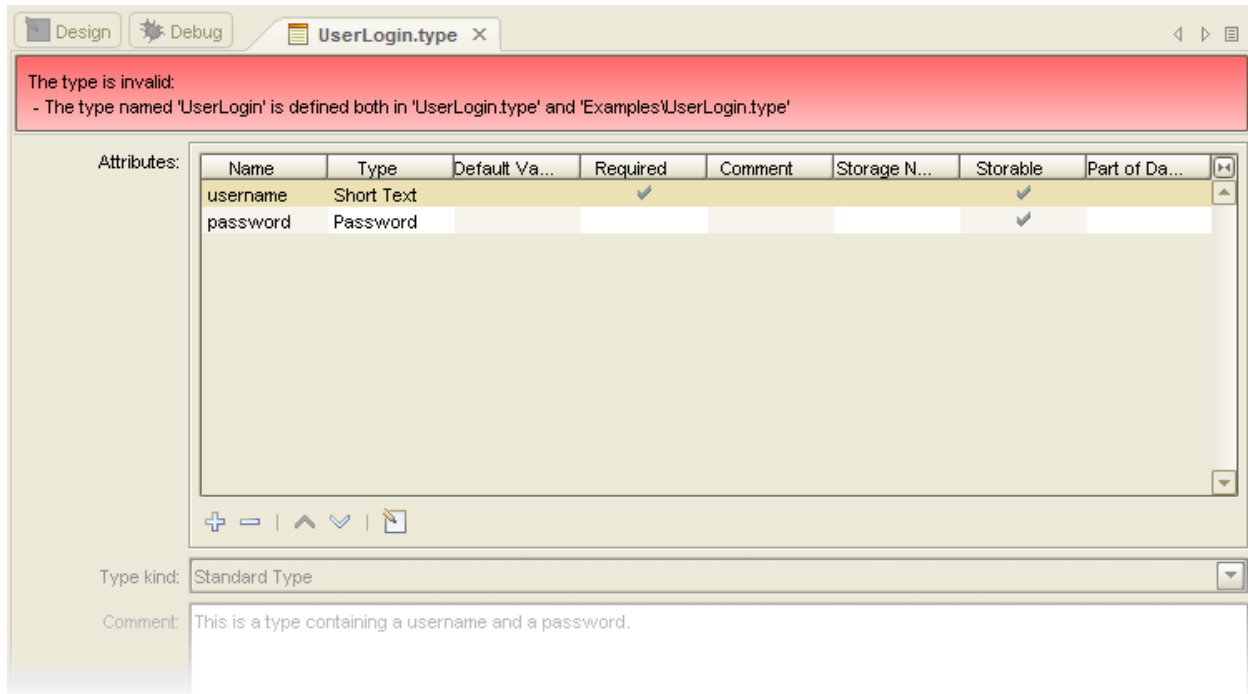

Also, the warning system will monitor which databases names are used in robots and assist in creating any missing mappings. The system performs a shallow monitoring of the databases, which means that it does not constantly ping the databases to see if they are online, but rather updates the information as needed. The system caches the table structures of the relevant database tables and uses this cache to compute any warnings to prevent an excessive number of database queries. The cache is recreated when Design Studio knows something has happened that requires it. Any external modifications of the database tables or the database availability are not monitored. There is the option of rebuilding the database cache for a single database or for all databases. This option is available through the database view, and through and through warnings, as applicable. For instance, to recreate the cache for a database, right-click it in the Database view and select **Refresh**.

Create Database Tables

To store extracted variable values in a database, you create matching tables in the database. Design Studio can assist in creating these tables by examining the types you have created, and generating the appropriate SQL. When storing the value from a variable of some type, tables representing that type must be present in the database.

1. In the Tools menu, select **Create Database Table** . The Create Database Table window appears.
2. Enter a name for your database.
3. Define the database type, and table types that you want to create.
4. Click **Generate SQL**. The system suggests a SQL statement for creating the tables.

5. Modify, execute, or save the statement.

The SQL shown is a recommended suggestion: you can change the statement to fit your needs, if required. For example, you might change the column type for a Short Text attribute from "VARCHAR(255)" to "VARCHAR(50)" to conserve database space, or you could add an auto-incrementing primary key. However, under normal circumstances, you should not modify the table name or any column names, or remove any of the columns.

Note If the database table already exists, it is dropped from the database when executing the SQL (because of the DROP TABLE statement at the beginning).

Store Data in Databases

This section explains how Kapow database storage works.

Object Keys

The tables you create for a type in a database have a column for each of the attributes in your type, plus an additional 7 household fields, named: ObjectKey, RobotName, ExecutionId, FirstExtracted, LastExtracted, ExtractedInLastRun, and LastUpdated. The most important field is ObjectKey, as it is the primary key for the table.

Note The reason for the name "ObjectKey" is found in the terminology previously used in Kapow. Previously, types and variables were called "objects." To adhere to the new terminology, "ObjectKey" should be called "ValueKey." Renaming it would cause quite a lot of backward compatibility problems, though, and therefore it has been allowed to keep its old name.

The ObjectKey for a type is what uniquely identifies values extracted from variables of that type when stored in a database. You have to figure out what uniquely identifies values of the type. If you are building a car repository, the VIN number may be enough to provide unique identification of each car. If you are collecting baseball results, you may need the year, team names, ballpark, and date to uniquely identify each match.

As you build the type you can select how the ObjectKey is going to be calculated. This is done by checking the "part of database key" option when creating a new attribute. For our car example, the VIN number would be the only attribute marked as part of the database key, for the baseball match example, the attributes year, team names, ballpark, and date would all be marked as part of database key.

The robot developer may also specify the key directly on the Store in Database action, to override the default algorithm defined on the type.

The attributes that are not part of database key are sometimes referred to as non-key fields. For example, the car might have a price attribute, but even if the price changed we would still consider it the same car.

Store in Database

Kapow provides three actions for managing values in a database: [Store in Database](#), [Find in Database](#), [Delete from Database](#). The Find and Delete actions are simple, but Store in Database does more than just store the value.

Store in Database may insert a new value into the table, or update an existing value that was previously stored. Here is a list of exactly what happens.

1. When storing the value of some variable, the ObjectKey is calculated based on the variable's values of the attributes which in the variable's type are marked Part of Database Key. If the robot developer specifies a key on the action, this key is used instead.

2. Using the calculated key, a check is made to see if the value already exists in the database.
3. If the value does not exist, a new row is inserted into the database (under this ObjectKey).
4. If the value already exists, it is updated, and all the non-key attributes are written to the table (under this ObjectKey).

Household fields

Whenever a value is inserted all the 7 household fields are updated. On update, only some fields change. The following table provides an overview.

Field	Description	Changed on
ObjectKey	The primary key for this value	Insert
RobotName	The name of the robot that stored this value.	Insert and Update
ExecutionId	The execution id for the robot execution that stored this value.	Insert and Update
FirstExtracted	The first time the value was stored.	Insert
LastExtracted	The last time the value was stored.	Insert and Update
LastUpdated	The date when the value was last updated.	Update
ExtractedInLastRun	If the value was extracted in the latest run (uses 'y' and 'n').	Insert and Update

After each robot execution (in which the robot used Store in Database), all values previously collected by this robot, but not stored during this run, will have ExtractedInLastRun set to "n" and LastUpdated set to "now", indicating that the value was not found on the website during the latest run.

Note If a value was found in the previous run, but no non-key fields have changed, then LastUpdated is not updated. However, if the value was not found in the previous run, but in a run prior to that, LastUpdated is updated even if the non-key fields have not changed. This means that the value was deleted from the site and then reappeared later.

Harvest Tables

The tables created by Kapow are often referred to as harvest tables, as the robots are harvesting data into them.

To find out what information was available on a website the last time the robot was run, you can use the following SQL command:

```
SELECT * FROM table WHERE ExtractedInLastRun = 'y'
```

If you are running queries against a table at the same time as a robot is storing data into the table, the result is comprised of data from the previous run, mixed with whatever data the executing robot has stored so far. We recommend that you copy the data out of the harvest tables and into a different set of production tables, so you can run queries against a stable data set.

There are many solutions where robots are used to store data in a database, but most of them fall under one of the three scenarios listed in the following table.

Scenario	Description
Repository matching website (small data sets)	<p>The idea is to have a repository that matches the items on a website 1-to-1. The easiest way to accomplish this is have a truncated production table (deleting all rows) every time the robot is done executing, and then copy every record where <code>ExtractedInLastRun='y'</code> from the harvest table into this table. This works well for small data sets.</p>
Repository matching website (large data sets)	<p>Same as above, but the data set is too large to copy all data after every robot execution. Instead we want to update the production table after each robot execution, based on the changes that occur.</p> <p>This is where the <code>LastUpdated</code> field comes in handy. All values that have been updated have a <code>LastUpdated</code> field value larger than the start time of the robot. You can get the start time from the database logging tables, or you can have the robot store it somewhere.</p> <p>To detect deleted values, use the following command:</p> <pre>SELECT * FROM table WHERE LastUpdated > 'StartTime' AND ExtractedInLastRun = 'n'</pre> <p>To detect new values:</p> <pre>SELECT * FROM table WHERE LastUpdated > 'StartTime' AND ExtractedInLastRun = 'y' AND FirstExtracted > 'StartTime'</pre> <p>To detect updated values</p> <pre>SELECT * FROM table WHERE LastUpdated > 'StartTime' AND ExtractedInLastRun = 'y' AND FirstExtracted < 'StartTime'</pre> <p>Then update your Production table accordingly.</p>
Historic data	<p>The default setup allows you to see when a value was first extracted and when it was last updated, but you cannot see which run of the robot the value was found in. In this case, you should copy all the data from your harvest table into another table after the robot run, but in your new table the <code>ObjectKey</code> should not be a primary key. Instead, create an extra column called <code>RUN_ID</code> and use it together with the <code>ObjectKey</code> to create a compound primary key. If you don't need a <code>RUN_ID</code> you could simply create an auto-incremented column and use that as the primary key of your secondary table. Truncate the harvest table before each run.</p>

You don't have to copy all the household fields to your production table; only the `ObjectKey` is required for you to update your production tables

Concurrency Considerations

If you have multiple robots storing values of the same type to the same database, be aware of the following considerations.

- Every time a value is stored, the `RobotName` column is updated. If you have two robots storing the same value (as identified by `ObjectKey`), only the last one will show after the robots are done executing.
- If two robots store the same value at exactly the same time, you get an error. They both find that the value is not in the table and try to insert it, but only one of them will succeed. In most cases, the error can be ignored because it is the same value.
- If you run the same robot twice at the same time and the robot stores data in a database, you break the way the `ExtractedInLastRun` column is used. When the first robot is done executing, it updates the `ExtractedInLastRun` to "n" for all values it has not stored. This includes all values stored by the

second robot so far. Later when the second robot finishes, it sets `ExtractedInLastRun` to "n" for all values stored by the first robot, completely negating the first run.

Value Relations

The storage system does not provide an automated way of managing relations between values. If you have a value of type `Person` and one of type `Address`, and you want to link them, you have to maintain this link.

The easiest way to create a link is to have the `ObjectKey` of the `Person` value be a foreign key in the `Address` value that should be linked to this person.

If the `ObjectKey` is calculated automatically from the type, you can use the `Calculate ObjectKey` action to generate the key and assign it to each of the address values before you store them.

You should be careful when building robots with connections between stored values. If an error occurs when you store the `Person` value, make sure that no `Address` values are stored.

ObjectKey Caveats

If you are using `MySQL`, `Oracle` or `Sybase`, review these important `ObjectKeys` rules.

- On `Oracle` empty string is stored as `null`.
- On `Sybase`, an empty string is stored as " " (a string with a single space).
- `MySQL` does not have millisecond precision in timestamps.

These three cases all result in a potential loss of data when the data is stored in the database. The `ObjectKey` is calculated inside the robot based on the data in the given variable. If you later load the value from the database and try to recalculate the `ObjectKey`, the `ObjectKey` is different if data loss occurred in any of the attributes marked as part of database key.

Robot Structure

Robots mimic human behavior; they do (more or less) what you do when you are looking for content on the Internet using a browser: You start by searching for the content. Once found, you read and process it. Similarly, most robots can be divided into two parts: a navigation part and an extraction part.

Navigation is concerned with "getting to where the content is." Navigation mainly includes loading pages and submitting forms. When navigating in `Design Studio`, you typically use the `Click` action to navigate through and among web pages.

Extraction is concerned with "getting the right content." Extraction mainly includes selecting, copying, and normalizing content from a web page that you navigate to. When extracting in `Design Studio`, you typically use the `Test Tag` action to skip uninteresting ("noisy") content, the `Extract` action to copy content into variables, and the data converters for normalizing the content so that it gets the format you want, such as the right date and number format. Once extracted, you output the value with the `Store in Database` or `Return Value` action.

A typical robot starts with one or more steps, each containing a `Load Page` or `Click` action to navigate to the interesting content on a web site. It proceeds with one or more steps, each containing an `Extract` action, and ends with a step storing or returning the extracted value.

Note that in many robots the navigation and extraction parts overlap because the content to extract is located on several pages. Again, this is similar to looking for content yourself; often, you have to visit several pages to get the content you want.

Most robots include other actions than the ones mentioned above, such as a For Each Tag action for loading several similar looking pages or extracting values from several similar looking table rows. Because robots have different tasks, they have different needs. For this reason, we have included a considerable number of step actions and data converters in Design Studio. Start by familiarizing yourself with the basic and most commonly used step actions and data converters, and then begin to explore. Experience shows that you can create most robots using only a handful of step actions and data converters. So, find your own favorite step actions and data converters and stick to them until you feel a need to explore others.

Write Well-Structured Robots

Writing well-structured robots is essential because each robot is a program. Writing unstructured robots is like writing books with no chapters or table of contents. Writing well-structured robots is important because:

- It helps document the robots.
- It makes it easier to maintain the robots.
- It makes it easier to find your way around the robots.

A side-effect of writing well-structured robots is that it can also make them load faster in Design Studio. As a result, robots are generally more responsive when they are edited in Robot View.

The two main tools for writing well-structured robots are Snippet steps and Group steps. Both step types are a way to take a part of a robot, give it a descriptive name, and pack it up in a single step. This way you can forget what the part of the robot does in detail and concentrate on the overall structure of the robot. This concept is similar to those in other programming languages, such as methods, functions, and procedures.

You use a group step to pack up and hide steps that perform a well-defined task. Give the step a descriptive name, such as Login to site X, Report error. It is important to give a relatively short descriptive name to the group step that describes what the steps inside the group do. If you cannot provide a good name, then it may be because the group does not perform a well-defined task. By introducing a group step you help document your robot, because the name describes what this part of the robot does.

Although snippets are mainly introduced to share functionality between robots, they can also be used inside a single robot to help structure it. If you have a collection of steps in a robot used in several branches, such as connections from different parts of the robot joining at the start of the steps, you can replace such steps sharing by introducing a snippet containing the steps.

The following robot structure uses snippets and groups instead of joining connections.

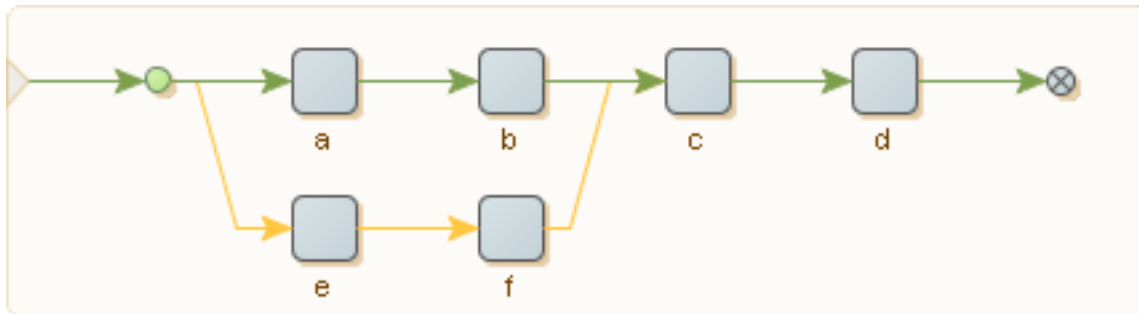

The last two steps c and d are shared by the two branches starting with the steps a and c. In real life you probably have a much larger robot and more than two branches sharing steps in this way, and the steps involved may be far apart. As a result, it may be difficult to get an overview of the robot. As a first step towards getting a better structured robot, you can introduce a snippet step containing the steps c and d as follows.

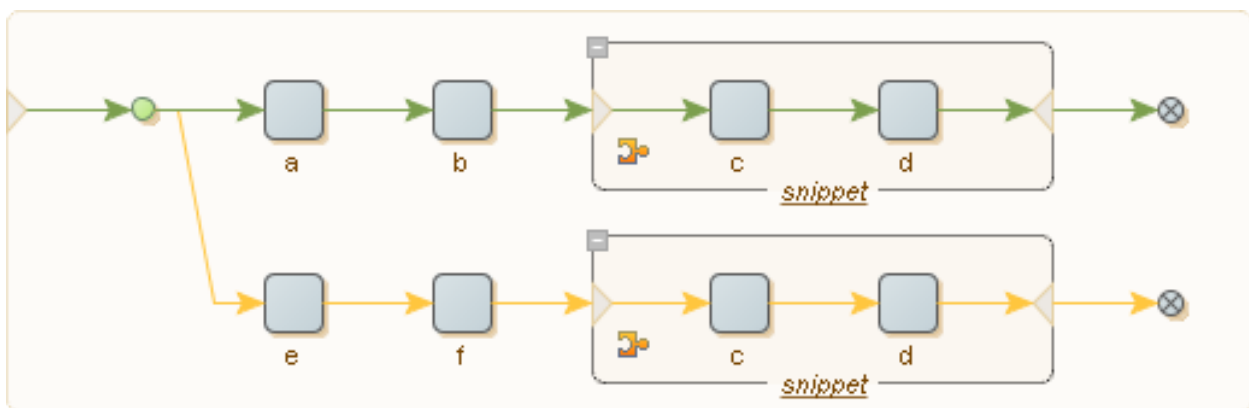

You can edit the steps inside the snippet steps and still be sure that the changes are shared in the two branches. You can structure the robot further by putting both branches into a group step:

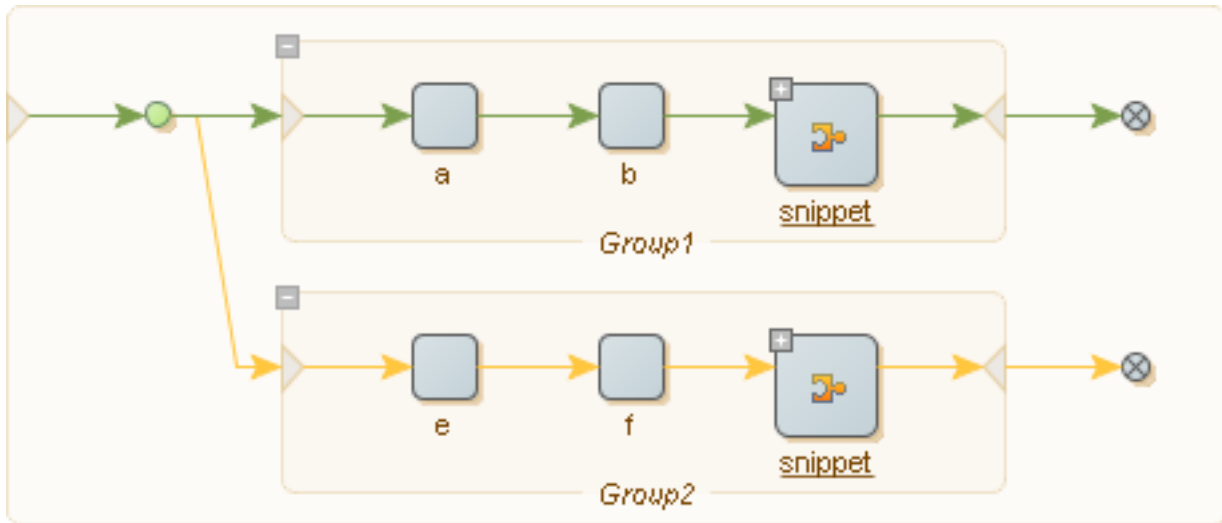

Finally, you can use the two group steps and get the following simple robot.

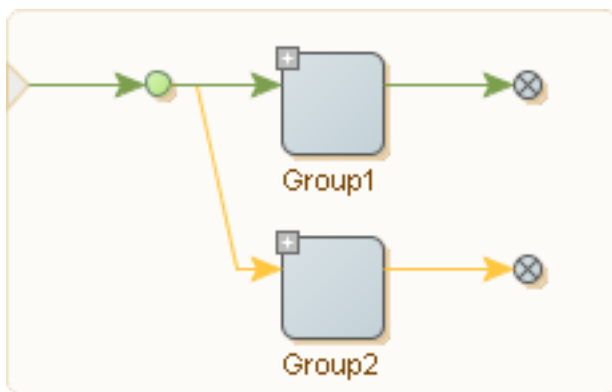

This resulting robot does two tasks, one performed by Group1 and the other performed by Group2. By giving these two groups descriptive names, the robot has a more logical structure than the original robot.

Admittedly this is a very simple example, but when robots get beyond a certain size and contain connections crisscrossing the Robot View they can become overly complex. Restructuring the robot in the manner described above may help ensure that the robot overview is manageable.

Determine the Page Type

You can create a Try step to identify the type of loaded page. Valid page types include HTML, XML, Excel, and Binary.

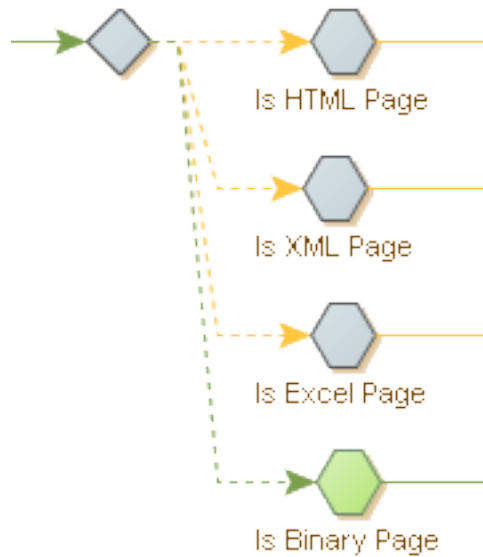

1. In the Designer, after a Load Page step, insert a **Try** step.
2. On the branch, Insert an action step and select **Test > Test Page Type**.
3. On the Action tab, Page Type field, select **HTML**.
4. On the Basic tab, change the Step Name to **Is HTML Page**.
5. Select the try step and click **Add Branch**.
6. Repeat 2 through 5, with Page Type set to **XML**, and the Step Name to **Is XML Page**.
7. Repeat 2 through 5, with Page Type set to **Excel**, and the Step Name to **Is Excel Page**.
8. Repeat 2 through 4, with Page Type set to **Binary**, and the Step Name to **Is Binary Page**.
Once the robot runs, the page type is highlighted.

Use Tag Finders

Use Tag Finders to find a tag on an HTML/XML page. The most common use of a Tag Finder is in a step, where the Tag Finder locates the tag to which you want to apply an action. The list of Tag Finders for the current step is located in the Tag Finders tab of the Step View.

Tag Paths

A tag path is a compact text representation of where a tag is located on a page. Consider this tag path:

```
html.body.div.a
```

This tag path refers to an `<a>`-tag inside a `<div>`-tag inside a `<body>`-tag inside an `<html>`-tag.

A tag path can match more than one tag on the same page. For example, the tag path above will match all of the <a>-tags on this page, except the third one:

```
<html>
  <body>
    <div>
      <a href="url...">Link 1</a>
      <a href="url...">Link 2</a>
    </div>
    <p>
      <a href="url...">Link 3</a>
    </p>
    <div>
      <a href="url...">Link 4</a>
      <a href="url...">Link 5</a>
      <a href="url...">Link 6</a>
    </div>
  </body>
</html>
```

You can use indexes to refer to specific tags among tags of the same type at that level. Consider this tag path:

```
html.body.div[1].a[0]
```

This tag path refers to the first <a>-tag in the second <div>-tag in a <body>-tag inside an <html>-tag. So, on the page above, this tag path would only match the "Link 4" <a>-tag. Note that indexes in tag paths start from 0. If no index is specified for a given tag on a tag path, the path matches any tag of that type at that level, as we saw in the first tag path above. If the index is negative, the matching tags are counted backwards starting with the last matching tag which corresponds to index -1. Consider this tag path:

```
html.body.div[-1].a[-2]
```

This tag path refers to the second-to-last <a>-tag in the last <div>-tag in a <body>-tag inside an <html>-tag. So, on the page above, this tag path would only match the "Link 5" <a>-tag.

You can use an asterisk (*) to mean any number of tags of any type. Consider this tag path:

```
html.*.table.*.a
```

This tag path refers to an <a>-tag located anywhere inside a <table>-tag, which itself can be located anywhere inside an <html>-tag. There is an implicit asterisk in front of any tag path, so you can simply write "table" instead of "*.table" to refer to any table tag on the page. The only exception is tag paths starting with a punctuation mark ('.'), which means that there is no implicit asterisk in front of the tag path, so the tag path must match from the first (top-level) tag of the page.

With asterisks, you can create tag paths that are more robust against changes in the page, since you can leave out insignificant tags that are liable to change over time, such as layout related tags. However, using asterisks also increases the risk of accidentally locating the wrong tag.

You can provide a list of possible tags by separating them with '|', as in the following tag path:

```
html.*.p|div|td.a
```

This tag path refers to an <a>-tag inside a <p>-tag, <div>-tag, or <td>-tag located anywhere inside an <html>-tag.

In a tag path, text on a page is referred to just as any other tag, using the keyword "text". Although text is not technically a tag, it is treated and viewed as such in a tag path. For example, consider this HTML:

```
<html>
  <body>
```

```
<a href="url...">Link 1</a>
<a href="url...">Link 2</a>
</body>
</html>
```

The tag path "html.body.a[1].text" would refer to the text "Link 2."

Tag Finder Properties

This topic describes the properties to use to configure a Tag Finder.

Find Where

Specifies where to find the tag relative to a named tag. The default value is "Anywhere in Page," meaning that named tags are not used to find the tag.

Tag Path

The tag path as described in [Tag Paths](#).

Attribute Name

The tag must have a specific attribute, for example "align."

Attribute Value

The tag must have an attribute with a specific value. If the Attribute Name property is set, the attribute value is bound to that specific attribute name.

- **Equals Text:** The attribute value must match a specified text. Note that the text must match the entire attribute value.
- **Containing Text:** The attribute value must contain the specified text.
- **Pattern:** The attribute value must match a pattern. Note that the pattern must match the entire attribute value.

Tag Pattern

A pattern that the tag must match (including all tags inside it), for example ".*.*Stock Quotes.*.*". Some caution should be observed in using this property, since it can have considerable impact on the performance of your robot. This is because the Tag Pattern may be applied many times throughout a page just to find the one tag that it matches. One way to try and avoid this is to choose Text Only for the Match Against property.

Match Against

The Tag Pattern should match only the text or the entire HTML of the tag. The default is to match only the text because this is normally much faster.

Tag Depth

Determines which tag to use if matching tags are contained inside each other. The default value is **Any Depth**. This value accepts all matching tags. If you select **Outermost Tag**, only the outermost tags are accepted, and similarly, if you select **Innermost Tag**, only the innermost tags are accepted.

Tag Number

Determines which tag to use if more than one tag matches the tag path and the other criteria. You specify the number of the tag to use, either counting forwards from the first tag or counting backwards from the last tag that matches.

For example, if you set the tag path to "table," the Tag Attribute property to "align=center," and the Tag Pattern property to ".*Business News.*," then the Tag Finder would locate the first <table>-tag that is center aligned and that contains the text "Business News."

Configure Tag Finders

There are multiple ways to define the tag path for a tag finder. Design Studio builds the path automatically when you interact with the browser\HTML\DOM path views to create an action or right-click and select "use this tag" or "use only this tag." Alternatively, you can manually define the tag path.

In the Page View, click Tag Finder to see the tag found by the Tag Finder.

Configure Tag Finders using one of the following methods:

- To configure Tag Finders manually, enter details in the Finder tab.
- To configure Tag Finders automatically, select a tag in the Page View and click **Set Selected Node in Finder**. This configures the Tag Finder to find the selected tag using a tag path in simple mode.
- To configure Tag Finders from a context menu, in the Page View, right-click a tag. If you select **Use Tag** from the menu, the Tag Finder is configured to find the right-clicked tag using a tag path in simple mode. Similarly, if you choose another action from the menu, it selects a corresponding step action and configures the Tag Finder to find the right-clicked tag.
- To configure Tag Finders for a step action, select a new step action. Some actions, when selected, configure the Tag Finders so that they find the tags typically used for that action. For example, the Submit Form action uses one Tag Finder and sets its tag path to "form" to locate the first <form>-tag in the page.

1. In the Designer, right-click a node and select **Insert Step > Action Step**,
2. Select an Action from the list.
3. On the Actions tab, define attributes based on the Action selected.
Required attributes are indicated with warning  symbol.

Submit a Form

Submitting a form is a common task in a robot. For example, you may need to submit a search form to get the search results you want to extract, or you may need to submit an order form to make an order transaction. In some cases, you do not need to actually submit the form, but simply want to create a URL that represents the form submission, or modify the current values in the form.

The recommended and simplest way of submitting a form in Design Studio is similar to the way you submit a form in an ordinary browser.

1. Fill in the form details.
You can use the following actions:
 - Enter Text
 - Enter Password Select Option
 - Select Option

- Select Multiple Options
 - Set Checkbox
 - Select Radio Button
2. Click the form submission button.
- You can also loop through field values (text input) options or radio buttons by using the following actions:
- Loop Field Values
 - For Each Option
 - For Each Radio Button

Form Basics

Consider the following example of a book search form, first shown as HTML, then as it appears in a browser.

```
<html>
  <body>
    <form action="http://www.books.com/search.asp" method="get">
      Author:
      <input type="text" name="book_author">
      <p>
      Title:
      <input type="text" name="book_title">
      <p>
      Language:
      <select name="book_language">
        <option value="lang_0" selected>English</option>
        <option value="lang_1">French</option>
        <option value="lang_2">German</option>
        <option value="lang_3">Spanish</option>
      </select>
      <p>
      Format:
      <input type="checkbox" name="book_format" value="format_pb">Paperback
      <input type="checkbox" name="book_format" value="format_hc">Hardcover
      <input type="checkbox" name="book_format" value="format_ab">Audiobook
      <p>
      Reader Age:
      <input type="radio" name="reader_age" value="age_inf">Infant
      <input type="radio" name="reader_age" value="age_teen">Teenager
      <input type="radio" name="reader_age" value="age_adult" checked>Adult
      <p>
      <input type="submit" value="Search">
    </form>
  </body>
</html>
```

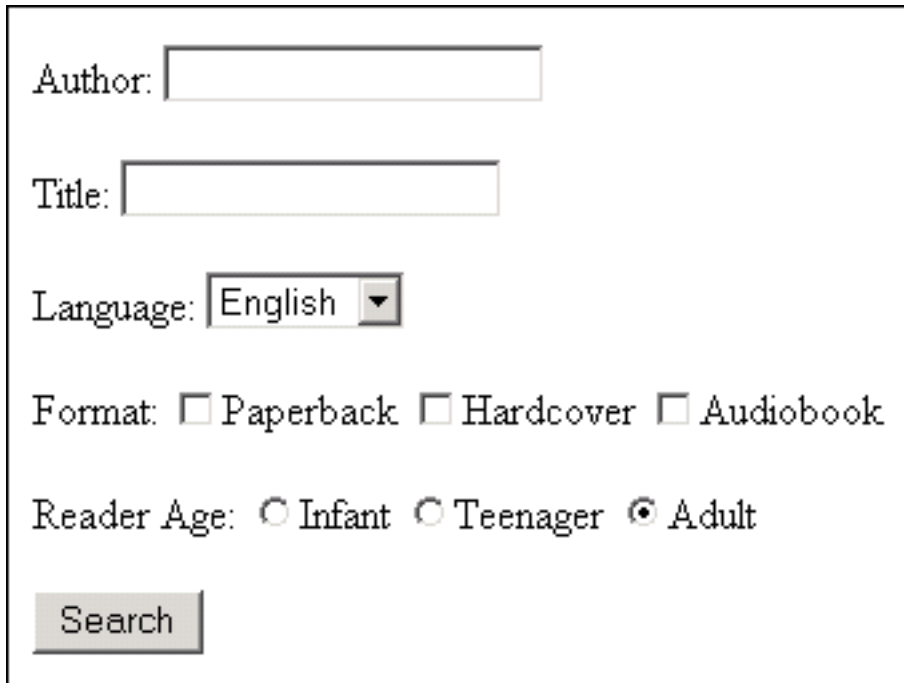

Author:

Title:

Language:

Format: Paperback Hardcover Audiobook

Reader Age: Infant Teenager Adult

A form contains a number of fields. For example, the first `<input>`-tag in the example form defines a field named "book_author". Note that the name of a field is usually different from what the user sees in a browser. For example, the "book_author" field will appear to be named "Author" in the browser, not "book_author".

A field can be defined by more than one tag. For example, the "book_format" field is defined by three `<input>`-tags in the example form. Tags that use the same field name and are of the same field type (text field, radio button, check box, etc.) define the same field.

A field can be assigned one or more values. For example, the "book_format" field can be assigned the value "format_pb" to select paperback format. Note that, like the field name, the value assigned to a field is usually different from what the user sees in a browser. For example, the user will see the text "Paperback", not the value "format_pb", when choosing the paperback format. Depending on the field type, some fields can be assigned more than one value at the same time. For example, since "book_format" is a check box field, we could assign both the value "format_pb" and the value "format_hc" to the "book_format" field to select both the paperback format and the hardcover format.

Most fields have a default value. The default value is the value that is initially assigned to the field in the form. For example, the "book_language" field has the default value "lang_0", because of the "selected" attribute.

A form is submitted by sending the current values of the fields to the web site. Only fields that have one or more current values are sent. For example, if none of the check boxes of the "book_format" field in the example form are checked, no value is sent for that field.

In a browser, the submission of a form usually happens when the user clicks a submit button. There are two kinds of submit buttons: normal submit buttons and image submit buttons. Normal submit buttons are defined using a `<button>`-tag or an `<input>`-tag, in both cases with the "type" attribute set to "submit". If

a normal submit button has a field name and value, that field is sent with the specified value when the button is clicked.

Image submit buttons are defined using an `<input>`-tag with the "type" attribute set to "image". An image submit button defines two fields, named "button name.x" and "button name.y", where button name is the name contained in the "name" attribute of the `<input>`-tag. If the `<input>`-tag has no "name" attribute, the fields are named "x" and "y". When an image submit button is clicked, these two fields are assigned the x- and y-coordinates of the position in the image where the mouse was clicked. Some web sites use this for creating image maps with different behavior depending on where the user clicks.

Some forms use JavaScript. For example, the `<form>`-tag may have an "onsubmit" attribute that contains JavaScript to be executed before the form is submitted. Similarly, an `<input>`-tag may have an "onclick" attribute that contains JavaScript to be executed when the user clicks on the field. The robot will automatically execute this JavaScript.

For performance reasons, you may decide to ignore the JavaScript execution when submitting the form. To do this, you must clear the "Execute JavaScript" option in the [options](#) in the form submitting step.

Determine the Step Action

The simplest way to submit a form is to fill in the form using the appropriate actions. For more complex submissions, you can loop through a form to get the desired result.

Consider the book search example form.

- To search for books in all available languages and for all reader ages, the site may not allow such a general search. You can loop through the languages and reader ages, making a form submission for each combination of language and age. To do this, use the Loop Form actions:
 - Loop Field Values
 - For Each Option
 - For Each Radio Button
- The Loop Form actions does not submit the form, so this must be done separately in a subsequent Click action that clicks one of the submit buttons of the form.
- To loop over a combination of field values, place several steps with Loop Form actions after each other prior to the Click action that submits the form.
- To create a URL that represents a submission of the form, use the Extract URL action on the form's submit button.

Use the Loop Form Actions

There are three Loop Form actions: Loop Field Values, For Each Option and For Each Radio Button. The three actions correspond to the three kinds of form controls for text input (INPUT elements with type "text" and TEXTAREA elements), options (SELECT elements) and radio buttons (INPUT elements with type "radio"). Watch the video below or read on to learn how to use these loops.

See [Loops in Forms](#) tutorial for more information.

To loop over a form, you need to decide which form controls to loop over and in which order (this determines the order in which output values are generated). Next, insert a step for each with the loops with the corresponding Form action. This can be done by right-clicking the control in the Page view and

choosing **Forms > <form action>** from the context menu, where <form action> is the appropriate action. For example, if the control is a text input control, you would choose **Forms > Loop Field Values**.

Every time a Loop Form action is executed, a value is changed in a form control element in the HTML page. This corresponds to what you would have done manually in a browser. If the form control has a JavaScript event attached to it, this event would be fired and some JavaScript executed. In some cases this JavaScript may change the form, such as the options of a SELECT element. In this case you must be careful and choose the right order in which to loop over the controls to ensure that the right options are available to the robot when it needs them. Normally, if you follow the order that you would use when doing this manually in a browser, it should work just fine.

Once all the Loop Form action steps have been inserted in the robot, you should add a step with a Click action that clicks one of the submit buttons of the form.

Upload Files

Some forms contain file fields that allow you to upload files. A file field is defined by an <input>-tag of type file, such as the following:

```
<INPUT type="file" name="attachedFile">
```

In the Select File action, there are two ways to upload a file using a file field.

1. The first way is to upload a file from the file system. To do this, select **File in Local File System** from the list and enter the file name. When the form is submitted, the specified file is loaded from the file system and uploaded as part of the form submission.

Note The file name must be an absolute file name, including the drive name, if any, and the directory path to the file.

2. The second and most common way to upload a file is to specify the file contents to upload, instead of loading the file from the file system. To do this, select **File Contained in Variable** from the list. Then, you may select the variable that holds the file contents from the File Content list. Typically, you get the contents from either a binary variable in which you have downloaded the file earlier using the Extract Target action, or from a variable containing text that you have extracted earlier.

Optionally, you can specify the content type and the file name of the file. The content type should be the MIME type of the contents, optionally followed by a charset. You may use one of the predefined content types, acquire it from an attribute or specify a custom content type. For example, the content type could look like this for an image:

```
image/gif
```

and like this for a plain text:

```
text/plain; charset=iso-8859-1
```

Note that when downloading files using Extract Target, you can store the content type and file name of the downloaded data in other variables. You can then use this information when uploading the file with the Select File action.

Use the Context Menu on the Page View

You can use the context menu in the Page View as a shortcut for selecting and configuring the Submit Form and Loop Form actions.

1. To select the Submit Form or Loop Form action in the current step, right-click inside a <form>-tag in the Page View.
2. In the context menu, Forms submenu, select **Use Submit Form** or **Use Loop Form**.
3. If the current step contains a Submit Form or Loop Form action, in the Page View, Forms submenu, right-click a field and select **Add Assignment to Field** in the Forms submenu.
A dialog box appears.
4. Assign a field value.
5. If the current step contains a Loop Form action, in the Forms submenu, right-click a field and select **Add Looping over Field** to loop through the field.
6. A dialog box appears where you can configure a **One field with values to loop through** field group for the field.
7. If the current step contains a Submit Form or Loop Form action, in the Page View, right-click a submit button.
8. In the Forms submenu, click **Select Submit**.

Loop Through Tags on a Page

A robot often needs to loop through elements on a page to perform some action on each element. For example, you might be interested in extracting certain properties from each result in a search or from each row in a table. The following topics explain how to do this:

- [Loop Through Tags with the Same Class](#)
- [Loop Through Tags with Different Classes](#)

Keep in mind, with multiple different types of loop steps, there are many ways to handle the same situation.

Loop Through Tags with the Same Class

There are a couple of ways to set up a loop. The first way is the easiest if it is viable, and involves looping over tags that all share a class attribute.

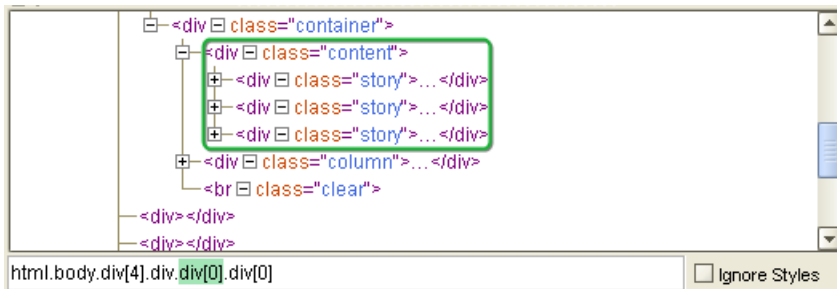

Note Each div element has the attribute `class="story"`.

To determine whether looping through tags with the same class is possible, find the elements in the HTML view. In the case shown above, it is possible to loop through the three div tags with the attribute `class="story"`.

1. Right-click the first tag and select **Loop > For Tags with Class > story**.

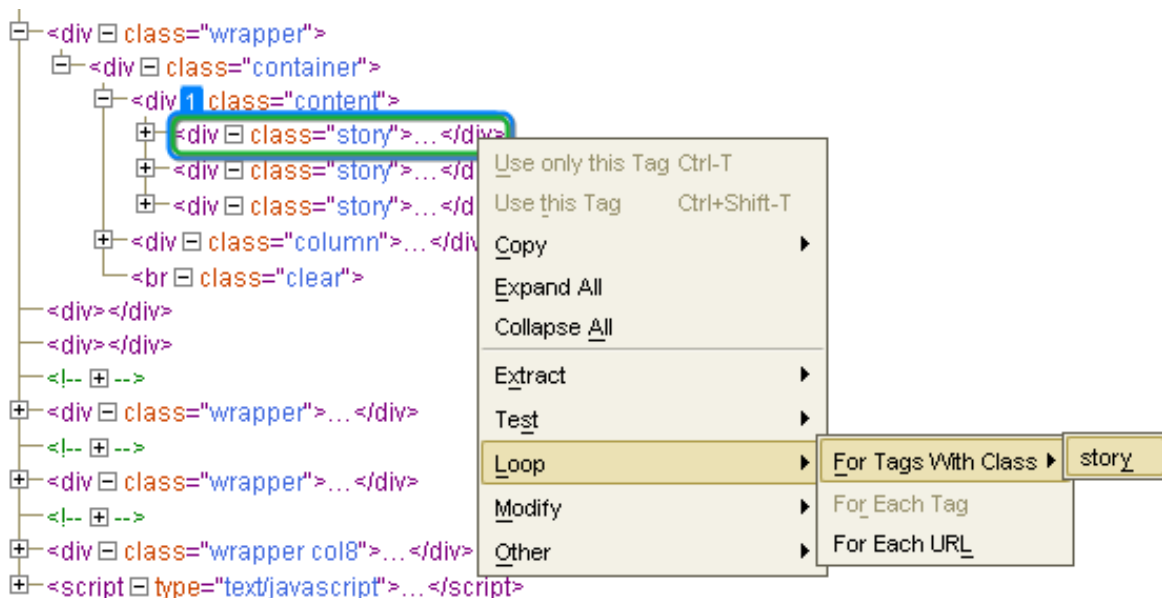

This creates a For Each Tag Path step in the robot, which loops through all elements on the page with the given class.

2. On the Loop step, use the arrows to ensure that the correct tags are included in the loop.
There might be other tags on the page that you do not wish to include in the loop but that use the given class. These can be excluded from the loop with an easy fix.
3. To exclude tags with the selected class, click **For Each Tag Path**.
Review the HTML view.

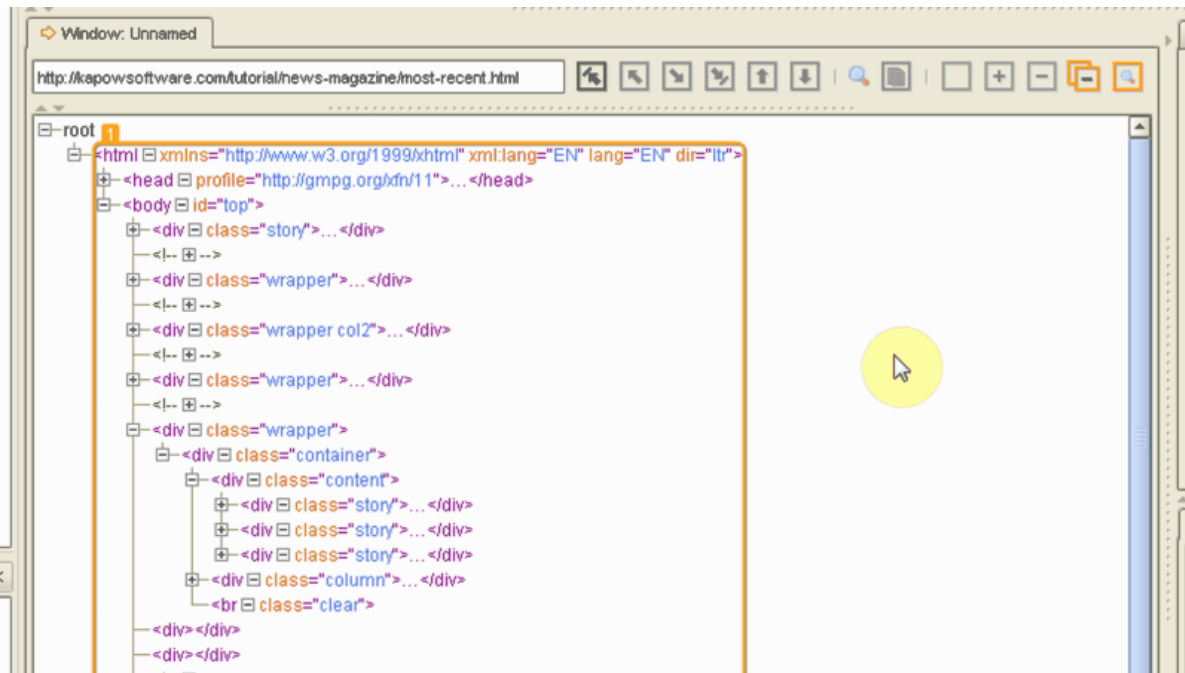

The For Each Tag Path has automatically included the entire page as the found tag. Notice the tag with `class="story"` near the top of the page. It is being purposely excluded from the loop.

4. Change the found tag to force the robot to only loop through tags within another given tag. Once the loop has been successfully created, any steps added after the For Each Tag Path step is repeated for each iteration of the loop.

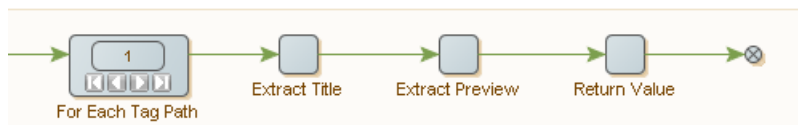

Steps after the loop step are executed for each iteration.

In the example above showing the robot view, the robot extracts two pieces of text, a title and a preview, and return those values, for each iteration of the loop.

Loop Through Tags with Different Classes

Looping through tags with the same class is a common scenario, but not the most simple one you might run into. Often it is necessary to loop through tags that do not all have the same class. An alternative scenario will be explored here.

The For Each Tag step is very efficient in most cases where For Tags With Class fails. The For Each Tag step loops over all types of tags, which are directly inside the found tag. It does take a little more configuration than just right-click and insert. Here is how to use it.

Use **For Each Tag** to loop over each tag of a given type, which is directly inside the found tag.

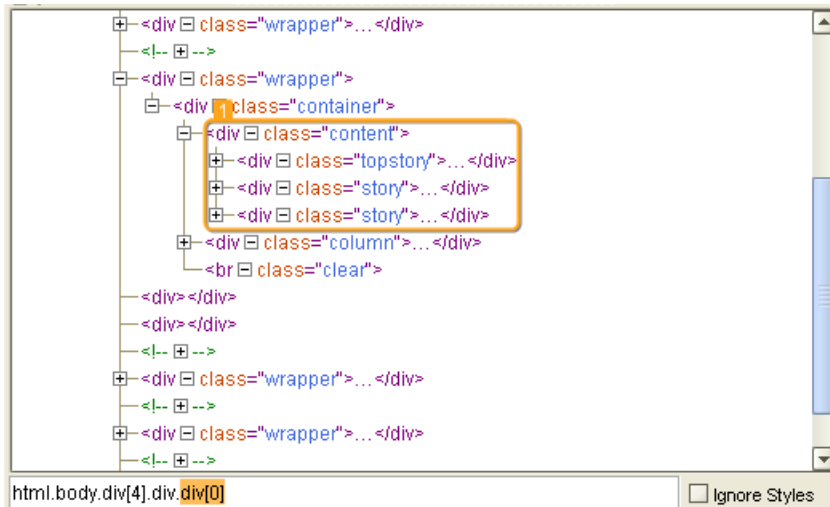

Note that the found tag contains three div tags, but they do not all have the same class. In this scenario, use For Each Tag to handle the differences.

1. Insert an empty New Step   and select the **For Each Tag** action.

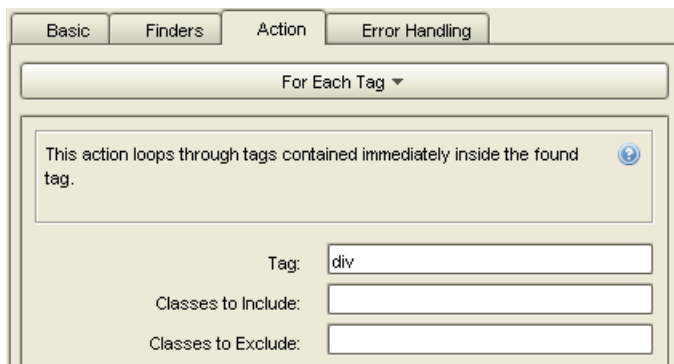

2. In the Page View, select the Found tag.
3. In the Step Action View, Tag field, select the tag type.
In the preceding example, the tag type is div.
4. Add steps after the For Each Tag step.
These steps are repeated for each iteration of the loop.

Loop Through HTML Pages

A robot often needs to loop through pages. For example, many web sites that present the results of a search request will do so over several pages, each containing e.g. 20 results from the search. To get the search results, you need to loop through the pages and process one page at a time. The following topics explain how to do this.

- [First Page Links to All Other Pages](#)
- [Each Page Links to Next](#)

First Page Links to All Other Pages

When the first page contains direct links to all other pages, you can follow a link to access any page directly from the first page.

Note The first page can also contain a link to itself.

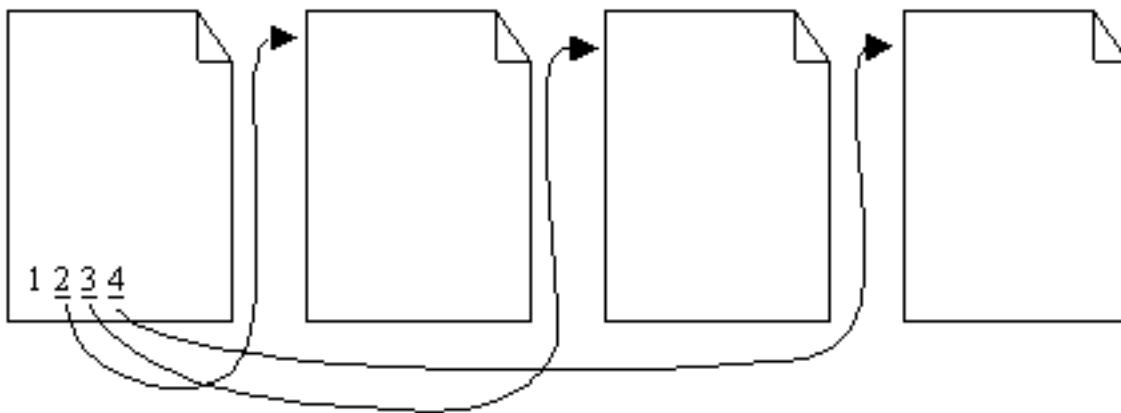

In this example, you can easily loop through pages using a For Each Tag step, as shown in this excerpt from a robot.

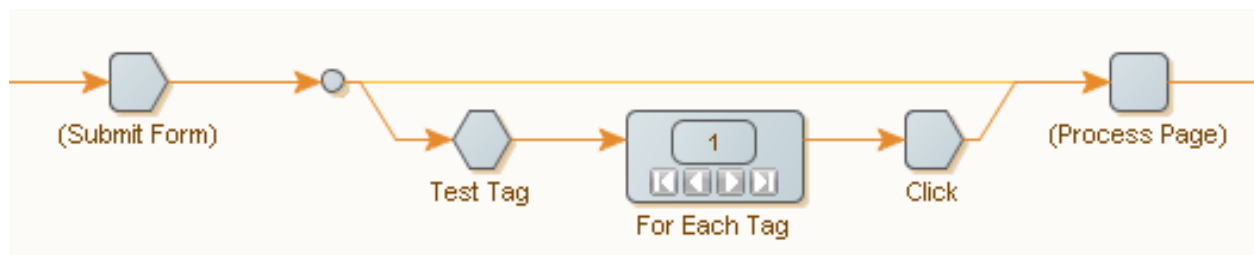

In this illustration, the robot loops through the result pages from a search request, symbolized by the Submit Form step.

The first result page is processed directly, shown by the connection from the form submission step directly to the Process Page step.

The remaining pages loop through using the For Each Tag action in the second branch.

The Test Tag step checks to confirm there is more than one page.

- If the first page links to multiple pages:
 1. Loop through the tags containing the links to the pages.
 2. Load each page using a Click action.
 3. Continue to page processing.
- If the first page links to itself:
 1. Configure the For Each Tag action to skip this first link.
The first page is not processed twice.

Each Page Links to Next

Pages are linked to a subsequent page, typically with a link at the bottom to the next page.

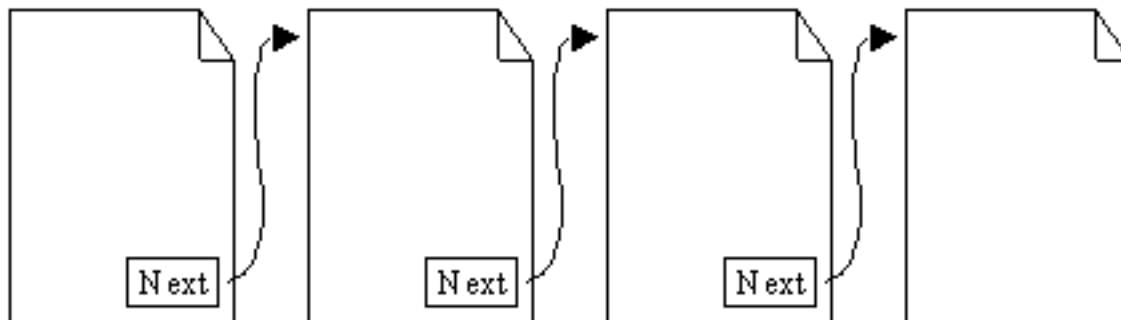

Use the Repeat action to loop through such pages. This action loops through the pages that are supplied to it by another action named Next. See the [Repeat-Next](#) tutorial for more information.

Repeat and Next must be used collaboratively to have any effect.

1. On the first page add a Repeat step.
2. Insert additional actions as required.
3. Insert a Next step.

When the robot execution reaches the next step, it reverts back to the repeat step and executes another iteration of the steps. The page is transferred to the repeat step and a new page is loaded with each iteration.

Note You can add other loops between the repeat and next steps to extract additional information from the page, as needed.

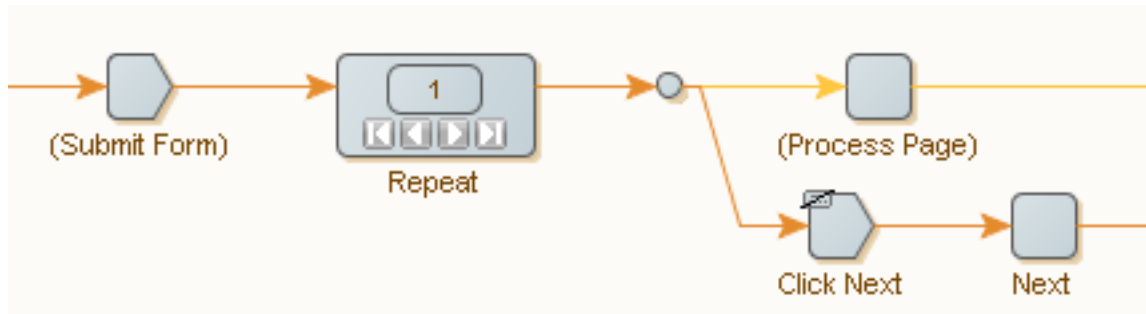

Here, like before, we are looping through the result pages from a search request, symbolized by the Submit Form step.

The form submission step will output the first result page, which we give to the Repeat action. In the first branch from the Repeat action, we process the current page. In the second branch, we load the next page by clicking its link. The Next action sends the page back to the Repeat action, which will output it in the next iteration. When the last page is reached, the Click action generates an error. To do this, the Click step is configured to terminate the loop. In the Click step, this is done in the Error Handling tab by setting the Then property to Break Loop.

4. To terminate the loop, In the Error Handling tab, set the **Then** property to **Break Loop**.

If the process does not find a Next page, the process terminates.

See [Handling Errors](#) for more information.

An alternative way of handling the last page is shown in the following robot excerpt:

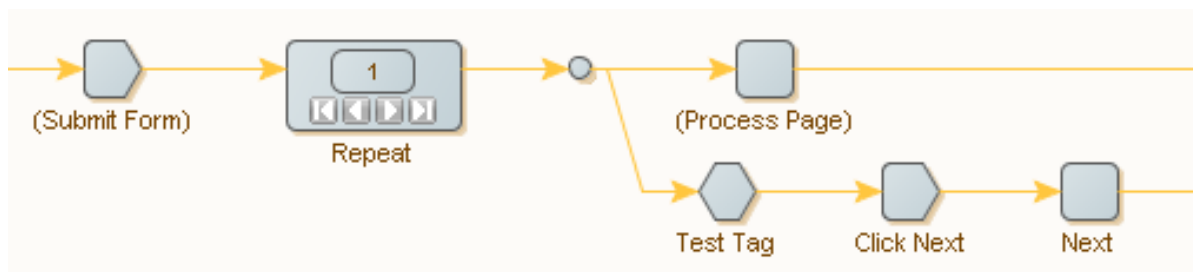

You can use a Test Tag action in a second branch to detect when the last page has been reached. The Test Tag action checks that the page contains a next-page link, for example by looking for an <a>-tag containing the text Next. If the page contains such a link, we load this page and give it to the Next action. When the last page is reached, the Test Tag action stops execution down the second branch, and no new page is given to the Repeat action, causing the loop to end.

Finding the link to the next page can be tricky. A common mistake is to find the previous-page link on some pages instead of the next-page link, because the layout of the pages changes slightly between the first page, the subsequent pages, and the last page. Another common mistake is to not detect the last page reliably. You may have to configure the tag finders of the steps carefully to make things work (see [Using Tag Finders](#)).

Note When you are working with a robot in Design Studio, you may not always be able to step correctly back and forth between iterations of a Repeat action. If you are not sure whether Design Studio has gotten it right, click Refresh to update.

Use Wait Criteria

Wait criteria in the *Continue when* option are powerful instruments to help you build robots that are faster and more reliable than in versions prior to 9.6.

Note Wait criteria are available when using the Default browser engine.

Every robot step, which requires the browser to start running, can now be configured with a set of criteria to pinpoint when the processing of an action (such as a click or a page load) has completed enough for the robot to continue.

The *Continue when* feature, combined with the built-in algorithm allows for browser steps to run only as-long-as-needed for the robot to be able to continue. Also the user can now point and click an element on the page and create a new stop criterion for the browser step.

Wait criteria can be specified in the following step actions:

- Click
- Close Window
- Create Page
- Enter Password
- Enter Text
- Execute JavaScript
- For Each Option
- For Each Radio Button
- Insert Tag
- Load Page
- Loop Field Values
- Move Mouse From
- Move Mouse To
- Press Key
- Raw HTTP
- Replace Tag
- Scroll
- Scroll To
- Select File
- Select Multiple Options
- Select Option
- Select Radio Button
- Set Checkbox

All robots created in Kapow version 9.6 and later have their default waiting set to *Page Stops Changing for 500 ms*. You can see this setting on the Advanced tab of the Robot Configuration window. All wait-criteria-enabled steps have a default *No Page Changes for 500 ms* wait criterion with the enabled

Resume button, which can be seen in the Result View. This wait criterion is always grayed out in the Wait view and always met. All other browser steps have a default *Initial Page Load Complete* wait criterion with the disabled **Resume** button. This criterion is also always grayed out in the Wait view and always met.

If you migrate the Default browser engine robot to a Classic browser engine robot, the following rules are applied:

- If a step in the Default browser robot has a specified wait criteria, this step in the Classic browser robot is set to *Wait Real-Time for Timer Events=true*
- If a step in the Default browser robot has Legacy timing, in addition to *Wait Real-Time for Timer Events=true*, this step in the Classic browser robot has *Max Wait for Timer Events* set to the time specified in Legacy timing.
- If you migrate the same robot back to the Default browser robot, wait criteria are not restored.

Adding Wait Criteria

To specify a wait criterion for a step, click **+** in the **Continue when** field and select a criterion:

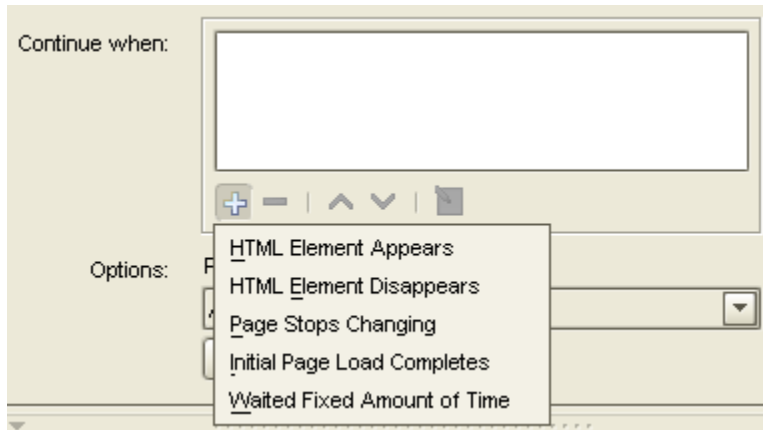

To add Wait criteria from the Browser and Source view after execution of a wait-criteria-enabled step, right-click the browser or source view, choose **Wait for** from the menu, and select a criterion. The step is re-executed after the criterion is added, which is shown by the **Re-execute step** button in the wait criterion configuration window.

Once the criteria are added, you can add, remove, move up, move down, and edit wait criteria using the panel under the list. Right-clicking a wait criterion in the **Continue when** list, opens an option menu to copy, cut, and paste a criterion.

You can add more than one wait criterion to a step. If you have several wait criteria, execution stops when any wait criterion is met. You can have several met wait criteria such as if you are waiting for two HTML elements that appear on the same load, or if you are waiting for an element on the main frame, and *Initial Page Load Completes* is set.

If adding a wait criteria to a wait-criteria-disabled step from a shortcut menu, the criteria is added to the previous wait-criteria-enabled step. For example, if you try to add a wait criterion after the Extract step as in the following example:



the criterion will be added to the Load Page step.

Wait View

The Wait view shows the results of wait criteria execution as well as disabled wait criteria.

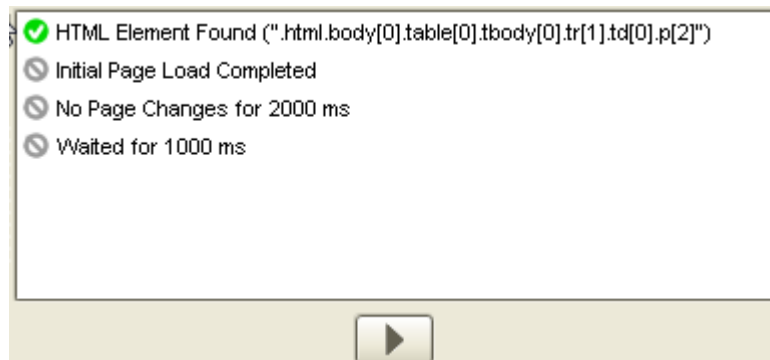

Right-clicking a criterion in the list opens a shortcut menu. You can enable, disable, and delete a criterion as well as open properties for the selected criterion. For **HTML Element Appears**, you can select an element found in the DOM in the Browser view.

This view also shows whether the page was completely loaded. If the page is loaded completely, the **Resume** button is disabled. If the page is not completely loaded, because of the short timeout, the **Resume** button is disabled and you need to extend the timeout.

The **Resume** button in the Wait view is used to resume the browser operation after a wait criterion is met. If you have several wait criteria and one of them is met, clicking the **Resume** button marks the met wait criteria with a grey sign and the browser continues working until the next wait criterion is met. Once all criteria are met, clicking the **Resume** button starts loading the page during the time specified in the *Timeout for Each Attempt* option in the [Options](#) dialog box.

Note The **Resume** button is enabled for wait-criteria-enabled steps.

For default wait criteria you can click the **Resume** button as many times as you want. For non-default wait criteria, you can click the **Resume** button only once.

If a wait criterion is displayed without an icon, the criterion is not met.

Wait Criteria Properties

Each wait criterion except *Initial Page Load Completes* has its settings. To configure a wait criterion, either double-click a criterion in the **Continue when** or **Wait** view, click  in the **Continue when** view or right-click a criterion in the **Wait** view and select **Properties**.

Disabling Wait Criteria

Wait criteria can be disabled and enabled in its configuration window. By default all criteria are enabled. To disable a wait criterion, clear the **Wait criterion enabled** check box. When a wait criterion is disabled, it is not taken into account during the step execution.

Note You can right-click a wait criterion and use the shortcut menu to disable and enable a criterion.

After you disable or enable a wait criterion, the previous step is re-executed.

Ignore All Pending Loads When Met

Each wait criterion except *Initial Page Load Completes* has the **Ignore All Pending Loads When Met** option that stops loading a page when a wait criterion is met. This option can help in cases when a wait criterion is already met, but timers continue execution and loading does not stop. This option is not selected by default. If the browser was stopped by this option, a warning sign is added to the green icon in the **Wait** view.

HTML Element Appears

This criterion is met when a specified HTML element is present in the DOM tree. This criterion configuration is similar to the [Tag Finders](#) tab in "Step Configuration", except for two elements in the **Found Element Must be** group:

- **Enabled:** If this option is selected, execution must stop when `result = !element.disabled;`
- **Visible:** if this option is selected, execution must stop when `result = style.display !== "none" && style.visibility !== "hidden";`

If HTML Element Appears criterion is met, it is marked in the Browser and Source views when you use the **Select in Browser View** command on the **Wait** view option menu.

HTML Element Disappears

This criterion is met when a specified HTML element disappears from the DOM tree. This criterion configuration is similar to the [Tag Finders](#) tab in "Step Configuration", except for an additional property: **Initial element Detection** that contains two options.

- If you select **Element is Found on Page** option, the robot waits until an element appears on the page and only after that the robot waits for the element to disappear from the DOM tree.
- If you select **Wait for Fixed Amount of Time** option, the robot waits the specified time and then verifies if element exists in DOM.
 - If the element is present in the DOM tree, the robot waits until the element disappears.
 - If the element is not present in the DOM tree, the wait criteria is met and the robot proceeds to the next step, even if the element has not appeared in DOM since the beginning of page load.

Page Stops Changing

This criterion is met if the DOM tree is not changing for the specified time. To set the time, open the criterion properties and specify a timeout in milliseconds in the **Timeout (ms)** text box.

Initial Page Load Completes

This wait criterion is met when the initial page load completes similar to the Javascript onload event.

Note Though this criterion does not have the **Stop All Loads When Met** option, by default the loading stops when all loads are met.

Waited Fixed Amount of Time

This wait criterion is met when the execution is waited for a specified time. To set the time, open the criterion properties and specify a time in milliseconds in the **Wait (ms)** text box.

Old Robots in Kapow 9.6 and Later

When you open your Default Browser robots created in Kapow version prior to 9.6, you can see the following *Default Waiting* settings on the *Advanced* tab of the *Robot Configuration* dialog box.

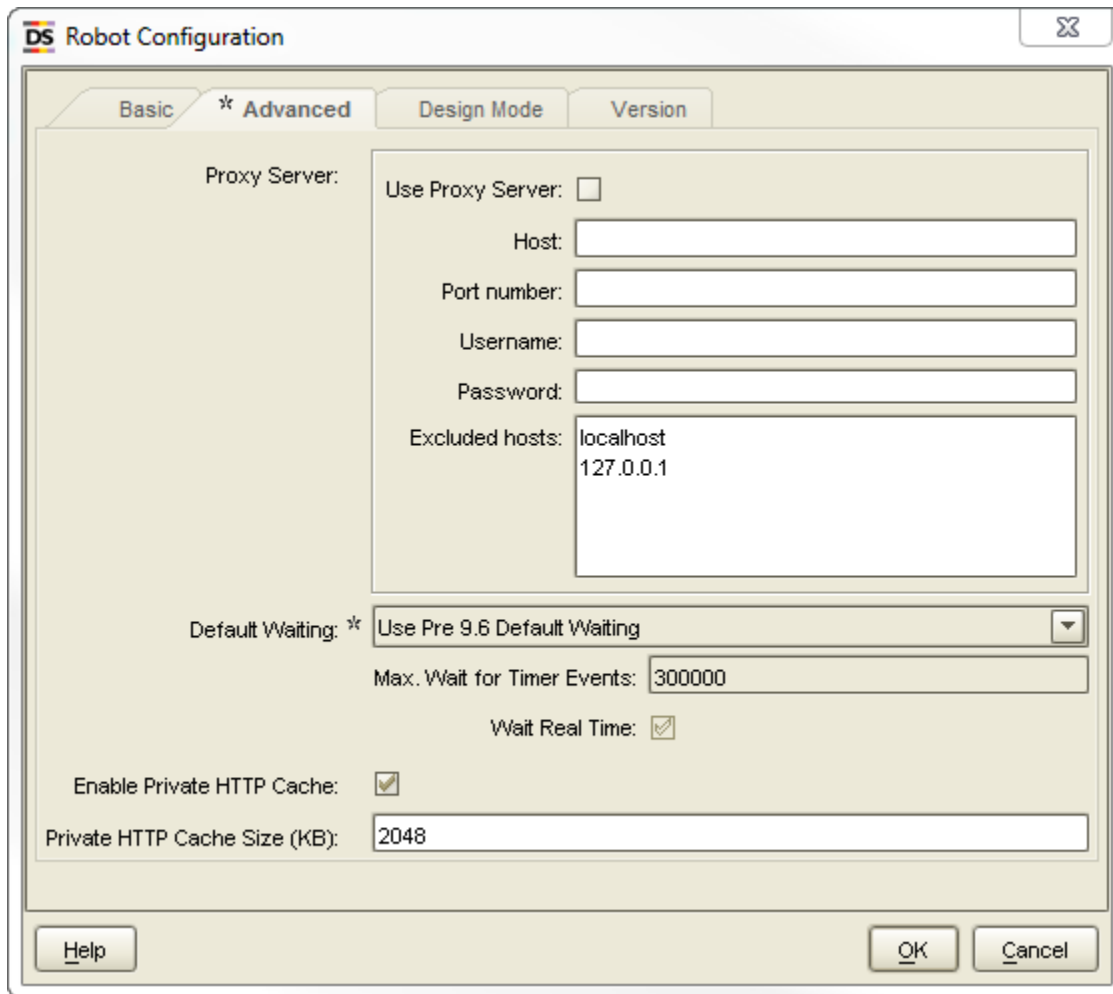

Default Waiting settings for Robots from previous releases is *Use Pre 9.6 Default Waiting*. For such robots you can change this setting to *Page Stops Changing for 500 ms.*

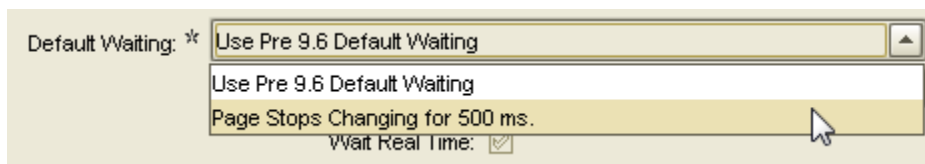

- If *Default Waiting* is set to *Use Pre 9.6 Default Waiting*, adding a new wait criterion to a step produces a warning.

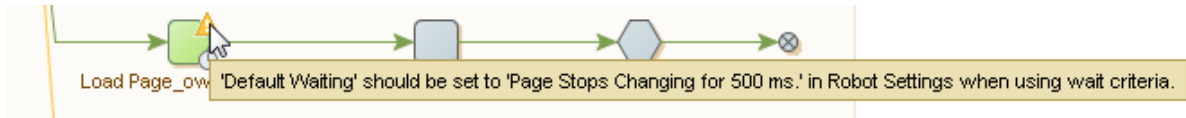

- If *Default Waiting* is set to *Use Pre 9.6 Default Waiting* and the step is set to use the *Legacy Timing* wait criterion, changing the *Default Waiting* to *Page Stops Changing for 500 ms* produces an error.

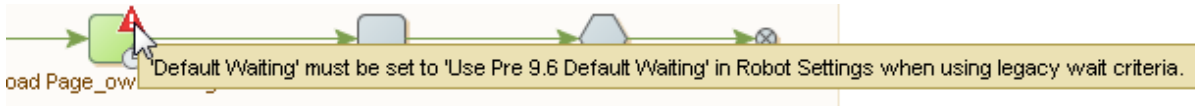

Upgrading Existing Robots to 9.6

If you open your robots created in Kapow version prior to 9.6 (9.3, 9.4, 9.5), depending on the **Max. Wait for Timer Events** and **Wait Real-Time for Timer Events** settings, you must perform different steps to use new wait criteria in your robots:

Max. Wait for Timer Events and Wait Real-Time for Timer Events settings are not default

If *Max. Wait for Timer Events* and *Wait Real-Time for Timer Events* settings are not set as default in your robots, Design Studio adds a non-editable *Legacy Timing* criteria to your robot.

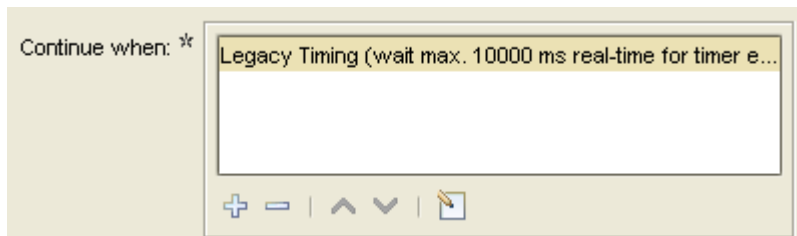

This wait criterion is always green after step execution. If you add any new wait criterion, *Legacy Timing* is automatically removed and you can take advantage of the new Wait criteria.

Max. Wait for Timer Events and Wait Real-Time for Timer Events settings are default

If *Max. Wait for Timer Events* and *Wait Real-Time for Timer Events* settings are set as default in your robots, you need to perform the following to switch to the new default settings when updating an existing robot to 9.6: go to the **File > Configure Robot** dialog box, click the **Advanced** tab and clear the **Use Pre 9.6 Default Waiting** check box. Now you can take advantage of the new Wait criteria in your robots.

Extract Content from HTML

Design Studio has six step actions for extracting content from a tag in an HTML page:

- The **Extract** action is used to extract text content from the tag, optionally including the HTML tags.

- The **Extract URL** action is used to extract a URL from a tag attribute containing a URL, and make that URL absolute.
- The **Extract Tag Attribute** action is used to extract the value of a tag attribute.
- The **Extract Target** action is used to extract binary data such as images and PDF files, but it handles any kind of binary data.
- The **Extract Form Parameter** action is used to extract a form parameter from a form URL in the found tag and then store its value in a variable.
- The **Extract Selected Option** action is used to extract the selected option from a <select>-tag and then store it in a variable.

To reformat (or normalize) the extracted content, use the Extract and Extract Tag Attribute actions and configure data converters in the list.

There are two actions to extract data from various binary data formats, for example, PDF or Flash. These are different from the preceding actions in that they extract the data and produce an HTML page that contains the data in a structured form that lets your robot access the data. These actions are used in an initial step before the actual data extraction, in which you may loop over the produced HTML and extract text.

- The **Extract Text from PDF** action is used to extract text from a PDF document contained as binary data in a selected attribute.
- The **Extract from Flash** action is used to extract data from a Flash object in a found tag.

Extract Text

1. On the Action tab, select **Extract**.
2. To extract short text, such as a product name or a price, extract as **Only Text**.
This extracts the text between the tags.
3. To extract longer text with sections, headings, and so on, you can select as plain text. If you want the text to appear close to how it appears in a browser, extract the text as **Structured Text**.
4. To extract with special markup, such as brackets surrounding the headings, select **Structured Text**.
Structured Text has rudimentary support for special markup.
5. If the markup requirements cannot be fulfilled using the Structured Text option, select **Advanced Structured Text**.
This option allows you to set mappings from the HTML tags into your proprietary markup.

Extract Binary Data

Extract binary data using the Extract Target action.

On the Action tab, select **Extract Target**.

The URL data is loaded and stored in a variable, or directly into a file.

Typically, binary variables are used to store the loaded data. The available types of binary variables include Binary, Image, PDF, and Session. They are all equivalent except that the Image, PDF, and Session types allow you to preview the data.

Use the Context Menu in the Page View

1. Right-click the text or tag to extract from, or right-click the link to load from.
2. On the Extraction context menu, select the appropriate option.

Perform Common Tasks

Extracting Only Part of a Text

To extract only a part of the text in a tag, you can use patterns on the text in the tag. For example, you might want to extract the name "Bob Smith" from the following text: "The article is written by Bob Smith." To do this, use the Extract data converter (do not confuse this with the Extract step action) and configure it as described in this topic.

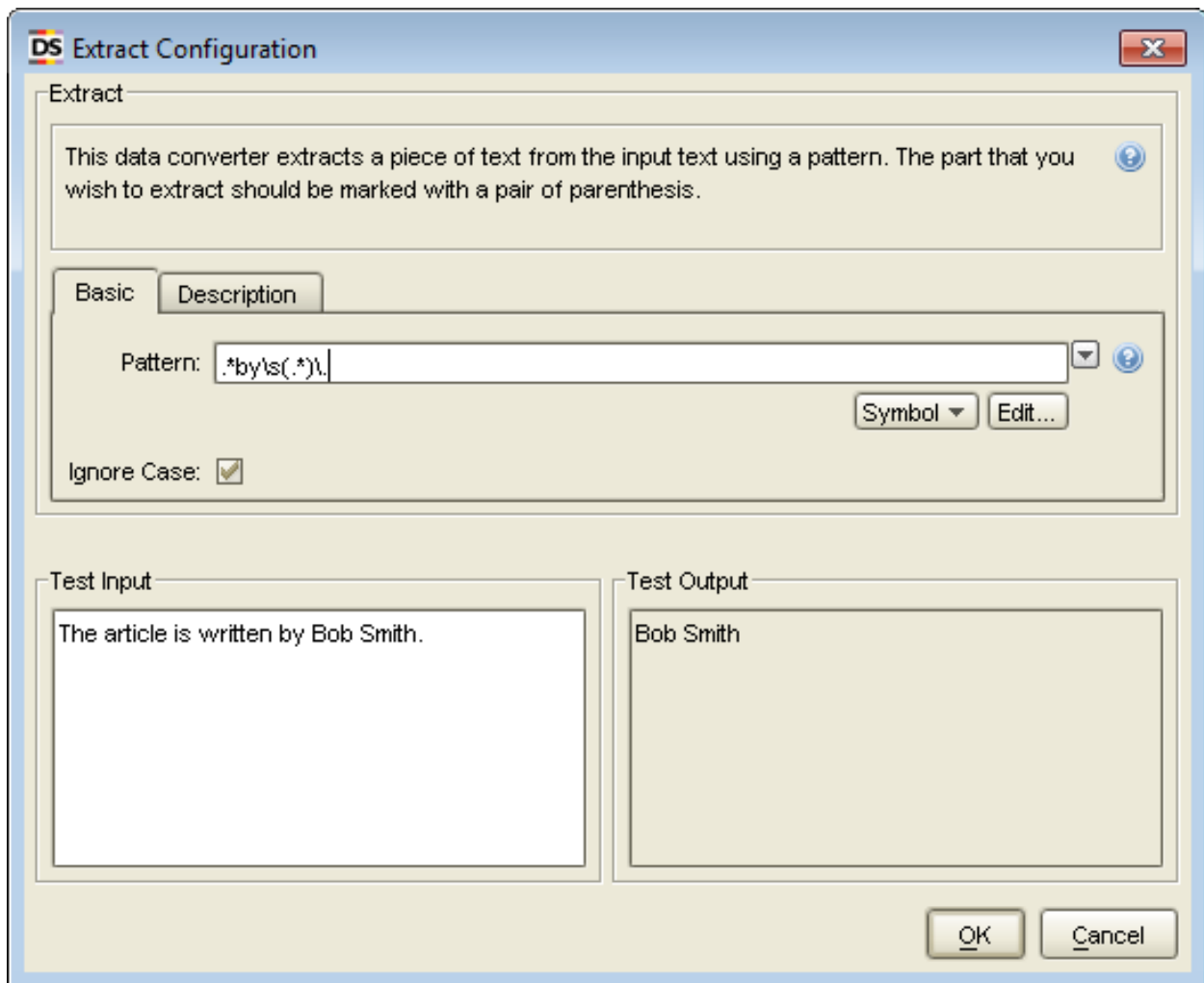

In this example, the pattern used is `".*by\s(.*)\."`, which means that the text between "by" and the period will be matched by the subpattern. For more information, see [Patterns](#).

1. Open Extract Configuration, and select the **Basic** tab.
2. In the Pattern field, enter the text pattern to extract.
Configure the Pattern property to match the entire text, with the text to extract matched by a subpattern, enclosed by parentheses.

Converting Content

To normalize content, use Conversion, such as replacing text with another text. For example, suppose you want to normalize country codes to their natural language description, such as normalizing "US" to "United States."

- For plain text conversions, use the **Convert Using List** data converter.
- For conversions based on patterns or expressions, use the **If Then** data converter.

Extracting and Formatting Numbers

1. To extract a number from content, add an **Extract Number** data converter.
2. To perform additional number formatting, use the **Format Number** data converter.

Extracting the Date from Text

Extracting dates should be done in the same fashion as extracting numbers.

1. To extract a date from text, add an **Extract Date** data converter to your robot.
Extract Date uses patterns to extract the date. The pattern does not have to match the entire text, only the date. The extracted date is converted to standard date format.
2. To perform additional date formatting, use the Format Date data converter.

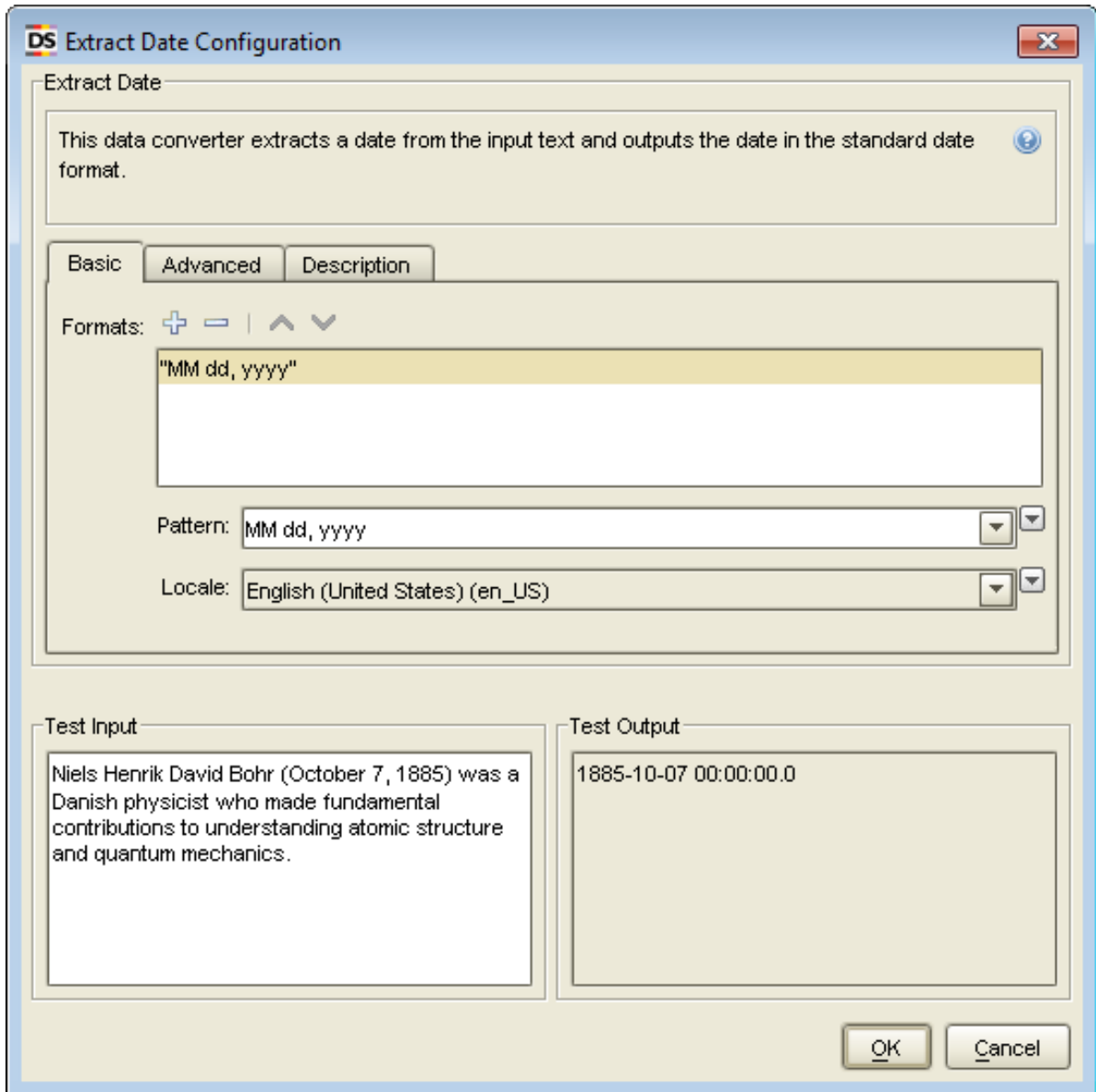

See the [Simple Date Extraction](#) and [Complex Date Extraction](#) tutorials for additional information.

Extracting Only a Subset of the Tags in a Found Tag

Sometimes, you want to extract from a range of tags rather than a single tag.

For example, consider the case of extracting the body text of an article, where the body text is made up of individual sections, each in their own tag, and where information about the article title and author is contained in some other tags. To extract only the body text without the article title and author, use the

Extract action to extract the text, and configure the action so that only the range of tags spanning the body is extracted.

1. On the Action tab, select **Extract**.
2. Specify the first tag in the range.
3. Specify the last tag in the range.

Extract Content From an HTML Table

HTML tables can be irregular in both content and structure. Design Studio has been designed to deal with such irregularities as described in this topic.

Note The techniques described in this topic are not limited to table content and structure irregularities. You can also use this technique to handle other tag irregularities.

1. Insert a Loop Rows step in your robot.
2. Configure the Loop Rows step with a For Each Tag action that loops through the <tr>-tags in the <tbody>-tag of a <table>-tag.
3. Add steps to extract content from a cell (column-wise) in a table row.

Example

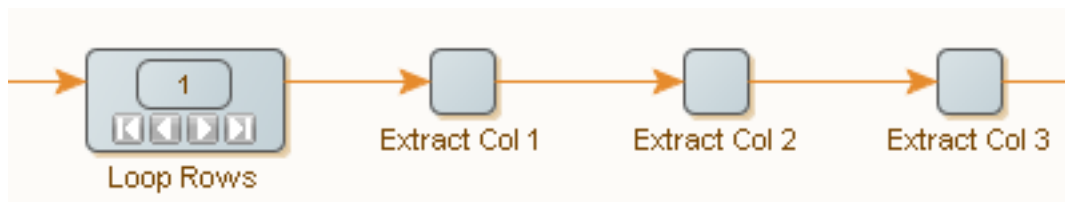

Note If the table content is perfectly regular in both content and structure, you can extract the content as described in [How to Extract Content from HTML](#).

Handle Table Content Irregularities

Cell content in the same table column may differ in format. For example, a cell can be empty, contain "Bob" (first name), or contain "Bob Smith" (first name and last name).

1. To handle content irregularities, in the extraction step, add an **If Then** data converter.
2. Configure **If** and **Else If** properties to match each format variation.
The corresponding **Then** properties extract the matching subpattern.

Note The Extract action only allows you to extract one value. In the "Bob Smith" case, which contains two values (first name and last name), you must create two steps: one that extracts the first name and one that extracts the last name. Both steps contain an Extract action with an If Then data converter so that the first step extracts the first name (if any), and the second step extracts the last name (if any).

Handle Table Structure Irregularities

Table rows may vary in the number of cells they contain. A common way of dealing with such irregularities is to test the format of each table row. For example, you might want to consider only rows containing a certain number of cells, or only rows containing a specific text.

1. Follow each For Each Tag step with a **Try** step.
2. Configure the Try step to loop through the table rows.
Each Try step branch handles one format. This can be done by starting each branch with a conditional step with "Try Next Alternative" error handling, for example a Test Tag action that accepts all rows matching some format (written as a pattern).
3. Follow the conditional step with one or more extraction steps that assume the format accepted by the conditional action.

It is sometimes possible to combine the conditional step and the extraction; to just try to do the extraction of a format and if it fails, try the next one.

The following robot uses both approaches.

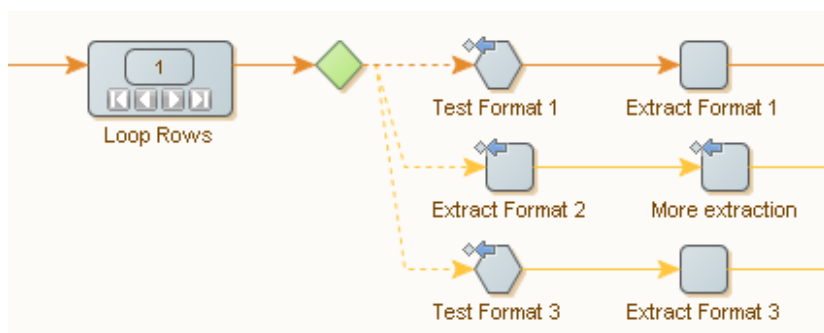

Note that the extraction of the second format is a two-step process. Because Try Next Alternative error handling is set up on both steps, the third branch is tried if either of the two steps fails. This represents a fairly complicated condition on the second branch.

When this robot is run, each branch is executed in turn until one succeeds. This implies that the conditions in later branches do not have to repeat the conditions from earlier branches; it is known that they failed.

Note You are not required to separate the branches beyond the conditional steps. If two or more branches share extraction steps, you may want to merge the branches after the steps that are different.

Local Files Usage in Robots

You can use Robots to load many types of files including HTML, Excel, CSV, and regular text files. This enables robots to extract data from a variety of sources.

- The following file types can be loaded natively by robots: HTML, XML, Excel, and JSON.
- Other file types can be loaded but are converted to HTML before being handled by the robot: plain text, CSV and PDF.

There are two procedures to load file types. If the file is located on the Internet, it is loaded using the Load Page action, specifying the URL of the file or using the Click action, clicking a link to the file. This automatically loads the file up in the page view. If the file is located on your system, load the file in the following way to ensure that the file is also available upon uploading the robot to the Management Console to be scheduled or added to a Kapplet.

All file types, except PDF, are loaded in the following way:

1. Add a binary type variable to the robot. (O)
2. In the Add Variable form, add a binary type variable to the robot.

Note Other variable types such as PDF and HTML can also be used, but are not as flexible as the binary type and may not permit user input.

3. Enter a name.
4. In the Type and Initial/Test values, select an option from the list.
5. Select the **Global** and **Use as Input** options as required.

Note The difference between checking and not checking Use as Input only matters if the robot is to be scheduled or used in a Kapplet in the Management Console. An input variable is definable by the user, and so the file will be interchangeable each time the robot is run. On the other hand, if the file should be the same each time the robot is run, there is no need to use an input variable.

6. Click **Load** to load a test file.

If you have not selected Use as Input, this test file is the final file.

A variable with an attribute of the type binary is added to a robot. It is defined as an input variable to allow users to input other files in Kapplets and Schedules.

An excel file is loaded into the attribute.

7. Next, on the Action tab, select **Create Page**.

8. In the Contents list, select the file.

This is used to load the file into the Page View. Before the step works, it should be configured to load the correct type of file.

To load the file content from the binary variable, a Create Page step is used. For the Contents field, the [value selector](#) is set to variable, and the binary type variable is chosen. Afterwards, the step is configured to load the correct type of content.

9. Click **Configure**.

10. On the Page Loading tab, Page Content Type, select **Same for All Pages**.

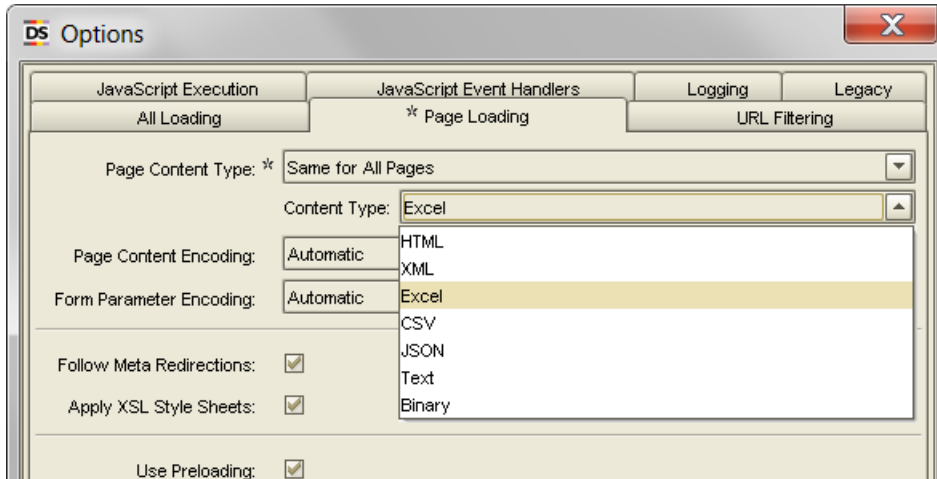

11. In the Content Type field, select the type of content you loaded. The Create Page step loads the file into the Page View.

Note To load PDF files, see [Extract from PDF](#).

To use an input file for a schedule, see [Adding a Single Robot](#) in the Management Console.

Load an Excel Page from a Variable

Even though the most common way to load a page in Design Studio is using a Load Page step, a robot may also receive Excel documents as input in a Binary attribute. You may want to load the Excel document into the robot to loop and extract data from Excel documents.

1. In your robot workflow, insert a **Create Page** step.
2. Configure the step to get its content from a Binary attribute.
3. On the Create Page step, Options configuration, Page Loading tab, set the Page Content Type to **Same for All Pages**.
4. In the Content Type field, select **Excel**.

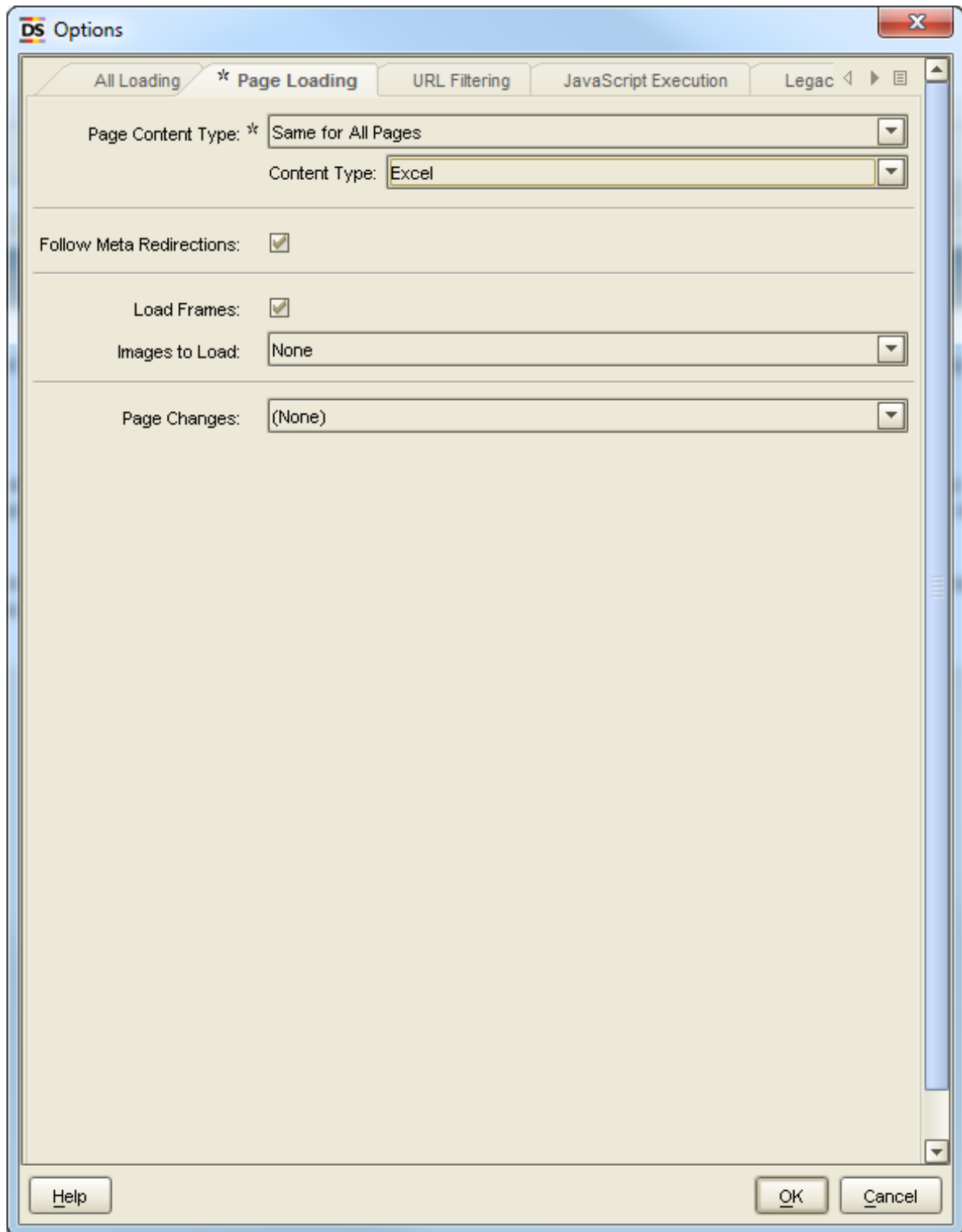

The robot can now recognize the Binary data from Excel pages.

Extract Content from Excel

Design Studio has three steps for extracting content from a spreadsheet:

- The Extract Cell step is used to extract text content from the found range.
- The Extract Sheet name step is used to extract the sheet name of the sheet of the found range.
- The Extract As HTML step is used to extract the found range of a spreadsheet as an HTML page containing a table with the cells of the range into a variable.

For the Extract Cell and Extract As HTML steps you can specify what to extract from the cells. This is controlled by the value of the Extract This option. The choice here is the same as the View Modes for the Spreadsheet View. The possible options are described in this topic.

Formatted Values

The extracted values are what you see in Excel and the values of dates and numbers are extracted formatted, which means that numbers may have fewer decimals than the actual values of the cells.

Plain Value

The extracted values are the actual values that Excel would show if the values of the cells were not formatted. For example, numbers would not have rounding of decimals.

Formulas

If a cell contains a formula, it is extracted or otherwise, it is the same value as for the Plain Values option is extracted.

If you create the steps by right-clicking the Spreadsheet View, the value of **Extract This** is set to the value of the selected **View Mode**. If you set the View Mode to Formulas and then right-click in the page view and select **Extract > Extract Text** from the context menu (into a text variable), the Extract This option of the Extract Cell action step is set to Formulas.

You may need to reformat (or normalize) the extracted content, and the Extract Cell action allows you to do this by configuring a list of data converters.

In the Spreadsheet view, right-click to create a step.

Select the desired extract step and specify necessary parameters

Extract Values from Cells

Use the Extract Cell step to extract the content of a cell or a range of cells into a variable.

1. On the Action tab, select **Extract Cell**.
2. Select an option in the Extract This field.

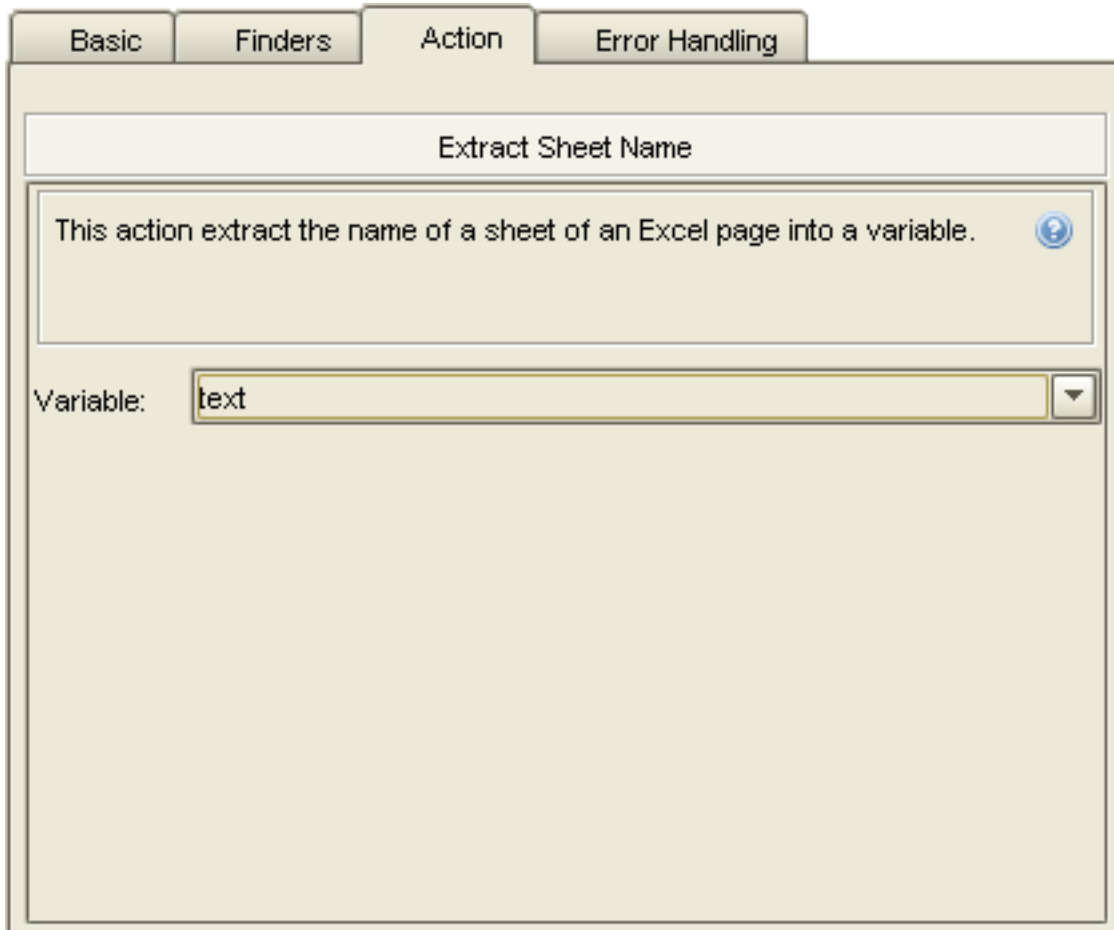

If the found range is a single cell, the value of this cell is extracted. If the found range contains more than one cell, the values of the cells are extracted as text in which the cells are tab separated and rows are separated by new lines. In both cases, the extracted value stored in the variable is created by applying the converters to the extracted value.

The value extracted from a cell is essentially the content of the cell in Excel taking the value of the Extract This option into account. For a blank cell, the value is the empty string, and if a cell is part of a merged cell such as C4:D6 (created in Excel by merging cells), the extracted value is blank unless the cell is the top left cell C4 of the merged cells.

Extract a Sheet Name

The Extract Sheet Name step is used to extract the name of a sheet. This step is useful when combined with a Test Value step to skip a sheet with a given name while looping over all sheets. This step is also useful to extract a sheet name to an attribute of a variable of complex type so that it becomes part of a returned value.

1. On the Extract Sheet Name step, Action tab, select **Extract Sheet Name**.
2. In the Variable field, select **text**.

This action extracts the name of an Excel page into a variable.

Extract as HTML

The Extract As HTML step is used to extract part of a spreadsheet document as HTML source code stored in a structured text variable, such as HTML type. The extracted code contains the extracted range (in a header tag), such as Sheet1:A1:H17, which means that the name of the sheet is contained in the code. The cells of the found range are placed in a table in the generated code. This step is mainly for obtaining an HTML version of part of a spreadsheet so that it may be returned for the robot and presented in a browser. It is also possible to use the step in a robot to create an HTML page with the extracted code using a Create Page step. We do not recommend using the Extract As HTML step to convert a spreadsheet into an HTML page to access its content in that way, because it might result in poor performance of the robot.

Test Cell Types in Excel

To test the content of a cell in an Excel page, first extract the cell content, and then use a Test Values step to perform the actual test. This is essentially the same as what you would do in other page types, such as HTML. To determine the cell type of a cell would not be straightforward or even possible by just extracting the content of a cell and subsequently performing a test on it; for example, there is no way to determine whether a cell is blank or contains an empty text. Fortunately, Design Studio contains a step to perform such a test: the Test Cell Type step.

You can test six different cell types. They correspond directly to what you can test for in Excel using functions such as ISTEXT or ISNUMBER.

Blank

Corresponds to the Excel function ISBLANK.

Text

Corresponds to the Excel function ISTEXT.

Number

Corresponds to the Excel function ISNUMBER. This type also includes dates since they are represented as numbers in Excel.

Logical

Corresponds to the Excel function ISLOGICAL, which correlates to the type Boolean in Design Studio.

Error

Corresponds to the Excel function ISERROR.

Formula

Corresponds to the Excel function ISFORMULA.

The Test Cell Type works like any other test step. It tests that the cell type in the found range matches a specified type, and based on the result, determines whether to continue along the branch or skip the following steps. The step is described in further detail in [Test Cell Type](#).

An important property of the Test Cell Type step is that it can test the type of many steps simultaneously. For example, consider how you would test an entire empty row. This test could be useful when looping

over a document containing several identically structured tables separated by blank lines. The following figure shows how to configure the Test Cell Type step. In this example, the branch following the step is skipped, if the cells in the found range are all blank.

The image shows a configuration dialog for the 'Test Cell Type' step. The dialog has four tabs: 'Basic', 'Finders', '* Action', and 'Error Handling'. The '* Action' tab is selected. The dialog title is 'Test Cell Type'. Below the title, there is a text box containing the description: 'This action causes execution beyond the step to stop or continue depending the type of the cell.' To the right of this text is a blue question mark icon. Below the text box, there are three dropdown menus. The first is labeled 'Condition:' and is set to 'Is Blank'. The second is labeled 'If: *' and is set to 'Condition is Satisfied'. The third is labeled 'Do: *' and is set to 'Skip Following Steps'.

The following figure shows how to configure the Range Finder such that it finds an entire row. In this case we have a named range called "row" that is set by a Loop in Excel step looping over rows and occurring before the Test Cell Type step. We have specified that the result should be the entire row, by selecting Whole of Range for the Use property.

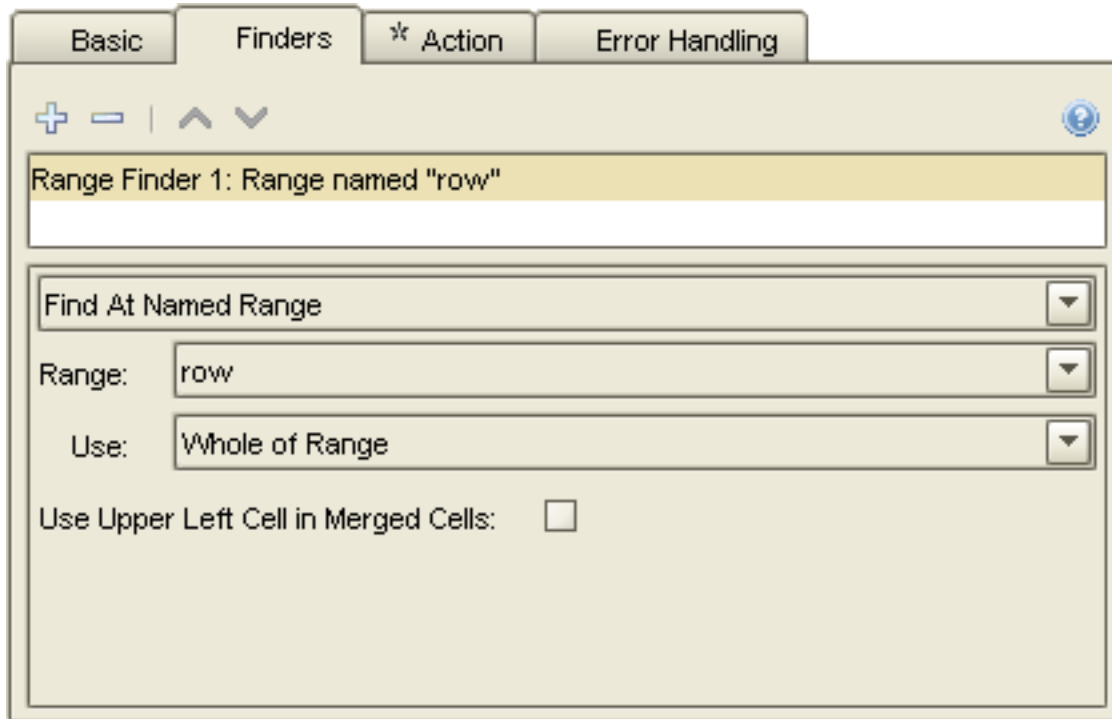

Loop in Excel

Looping in Excel is in many ways similar to looping in HTML, but much simpler due to the simpler structure of Excel. Essentially you may loop over all the sheets in a document or you may loop over the cells of a sheet either by looping over the rows, columns or cells of a found range. To loop in Excel you use the Loop in Excel step. This step has many options in common with steps that loop in HTML, such as "First index" and "increment," which are described in detail in [the reference documentation](#).

You can insert a loop step that loops through all the rows in a table.

1. In the "Using a robot which loads from an Excel document," click the upper left corner of the Excel view to select the entire spreadsheet.
2. Right-click inside the selected area.
A list of options appears.
3. Select **Loop > Loop Table Rows > Exclude First Row**.
This excludes the header row of the spreadsheet from the search. The Loop in Excel step now sets the first cell in the loop as the named range.
It is now possible to extract from the named range, and because of the loop, corresponding values are extracted from the other rows.
4. Right-click the top cell in a column just below the header and select the information to extract. For example, to extract a series of identifies, right-click the first cell in the ID column and select Extract, Extract Number, ID.
A wizard appears with the Format Pattern correctly configured.

5. Click **OK**.
The wizard closes.
6. Repeat steps 4 and 5 for each Named Value to extract.
7. Click **Debug**  to switch to debug mode.
8. On the toolbar, click **Run**.
The values appear in the results.
See the [Excel tutorial](#) for more information.

Loop Over Sheets and Rows

You can create a robot to loop in an Excel document with multiple sheets containing tables and with the same type of data. For example, each sheet in the Excel spreadsheet to display account information for a separate month of the year. In this case, you would have your robot first loop over the sheets and then over the rows of each sheet. You may also like to handle situations where the document contains a sheet that does not contain data of the same type as the other sheets, such as a blank sheet. The following image shows the structure of such a robot.



The first step in this robot is a Load Page step that loads the Excel document from a URL. The robot then contains a Loop in Excel step that loops over all the sheets of the document. For each iteration of this first loop step, the robot executes another Loop in Excel step that loops over each row of the sheet. The step looping over rows has its Error Handling property Then set to **Next Iteration**, which means that if the range finder of the step fails to match a range the size of the table, it goes to the next iteration.

This simplified error handling will handle the simple situation where a sheet is blank, but not situations where a sheet contains a table with entirely different types of data. In general, you would have to insert a step to extract part of the sheet followed by a step to test the structure. One example could be extracting the column headers and testing that they have some given structure. The following image shows the error handling added to a robot.

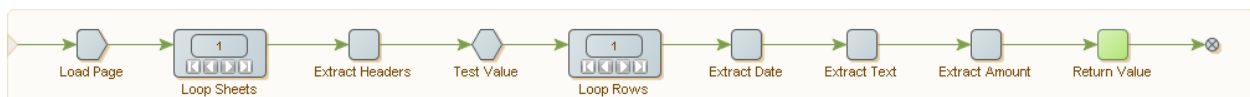

In this example, the Extract Cell step named Extract Headers, extracts the first row of the sheet into a variable and the Test Value step has a condition that tests the value. If the value matches, the robot executes the next step (the Loop Rows step). If not, the robot skips the following steps; the Do property of the Test Value step will **Skip Following Steps**.

Loop Over Merged Cells

A merged cell in Excel is two or more adjacent cells merged into one cell and shown as one. You can configure your robot to loop over merged cells. The content of a merged cell is stored in the upper left cell of the cells and all other cells are blank. Looping over a table that contains merged cells can cause extraction problems. For example, if you look at the following sheet that shows test results for students, notice that some student have missed their test and in some cases, two tests are shown using a merged cell.

	A	B	C	D	E
1	Test Results				
2		Test1	Test2	Test3	
3	Alice	12	7	9	
4	Bob	Missed		4	
5	Jane	11	8	7	
6	John	12	Missed		
7	Zach	10	Missed	7	
8					

Looping over the rows to extract the student test results may fail to extract the results correctly when a student has missed a test since the text "Missed" is not a number. To correct this, you can insert a test to search for the term "Missed" and then store the value 0 for a failed result. This test does not work for situations where the cell has merged. In the preceding example, this would work fine for the cell B4 since it contains the value "Missed," but it would fail to work for C4 since the content would be a blank value.

Instead of having yet another test for blank cells, you can use an **If Then** data converter on all Range Finders to identify a single cell inside a merged cell, and return the upper left cell of the merged cell.

1. On the Finders tab, description field, enter **Range Finder 1: Column at +2(in range named "row")**.
2. In the Range field, select **row**.
3. In the Use field, select **Column At Position**.
4. In the Column field, select **By Index**.
5. In the Offset field, enter the integer **2**.
6. In the Height field, select **Same as Named Range** and enter the description, **Height is to the bottom of the named range**.
7. Select **Use Upper Left Cell in Merged Cells**.

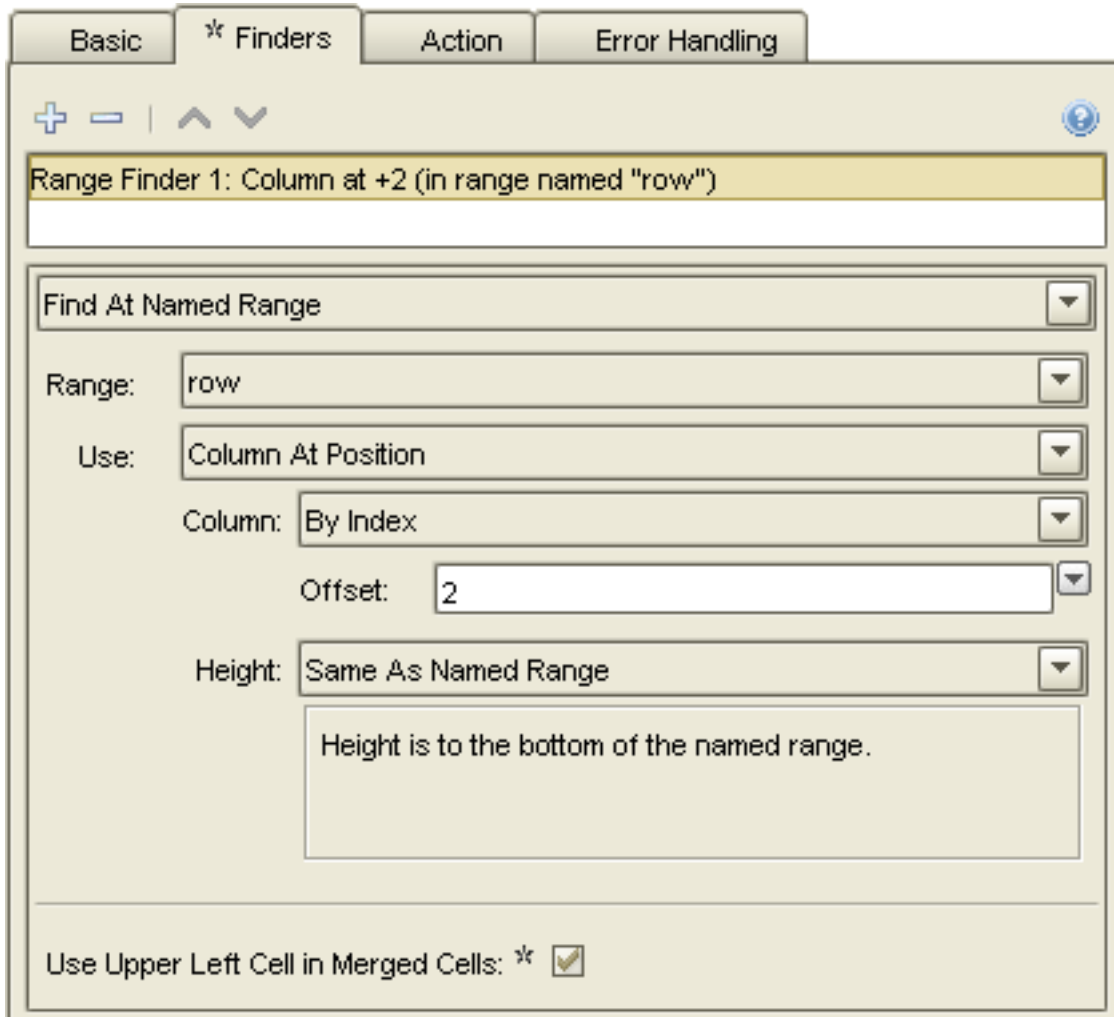

8. In the Action tab, Extract This field, select **Formatted Values**.
9. In the Converters field, enter an If Then statement. For example, `if contains "Missed" then "0"`
Else INPUT.
The Extract cell tests for the text "Missed" and uses 0 for the result. If Missed is not found it uses the extracted value.

Work with Variables in the Windows View

The Windows View shows part of the current robot state, such as a loaded HTML page or a JSON document. Variables or attributes of certain simple types (XML, JSON and Excel) can also be shown in a tab in the Windows View. When a variable is shown in the Windows View, you may operate on it in the same way as other documents loaded in the Windows View. For example, you can extract, test, and loop over, and in most cases you can also modify the variable.

As an example you may want to call a web service that takes some XML as input, and as output also returns some XML. You may then create the input XML using an XML variable that you modify using a step action that works on the content of the window showing the variable. When it has the desired form, you may feed it as input to a web service step action. You can have this web service step action store the response in another XML variable, which you may then loop over and extract data from.

Open a Variable

To work with a variable (or an attribute) in a window, you must first open the variable in a new window. You do this with an Open Variable step action.

The easiest way to do this is to right-click the variable in the Variables View and select the menu option **Insert Step > Open Variable**.

1. In the Variables View, right-click the variable and select **Insert Step > Open Variable**.

When this step is executed, a new window shows the content of the variable. In this way the Open Variable step action behaves much like the Load Page step action.

If the variable is already open, no new window is opened; but the window containing the variable becomes the new current window. In this way the Open Variable step action behaves differently from the Load Page step action and more like the Set Current Window step action.

Even though the step action is call Open Variable, it also works on attributes of variables if they are also of a type that may be opened in a window.

Once a variable (or attribute) is open, you work on it just as you would on a document (such as an XML document) loaded from a URL.

You can insert a step action to operate on the variable by right-clicking in the view. The insert steps will work on the current window whether it is loaded (opened) from a variable or a URL. The only real difference is that document loaded from a URL may not be modified, and it is considered immutable. To modify a document you must first extract it into a variable and then modify it.

2. On the Variables tab, right-click XML or All New and select configuration options.

The following figure shows how to open an attribute of a JSON variable of complex type.

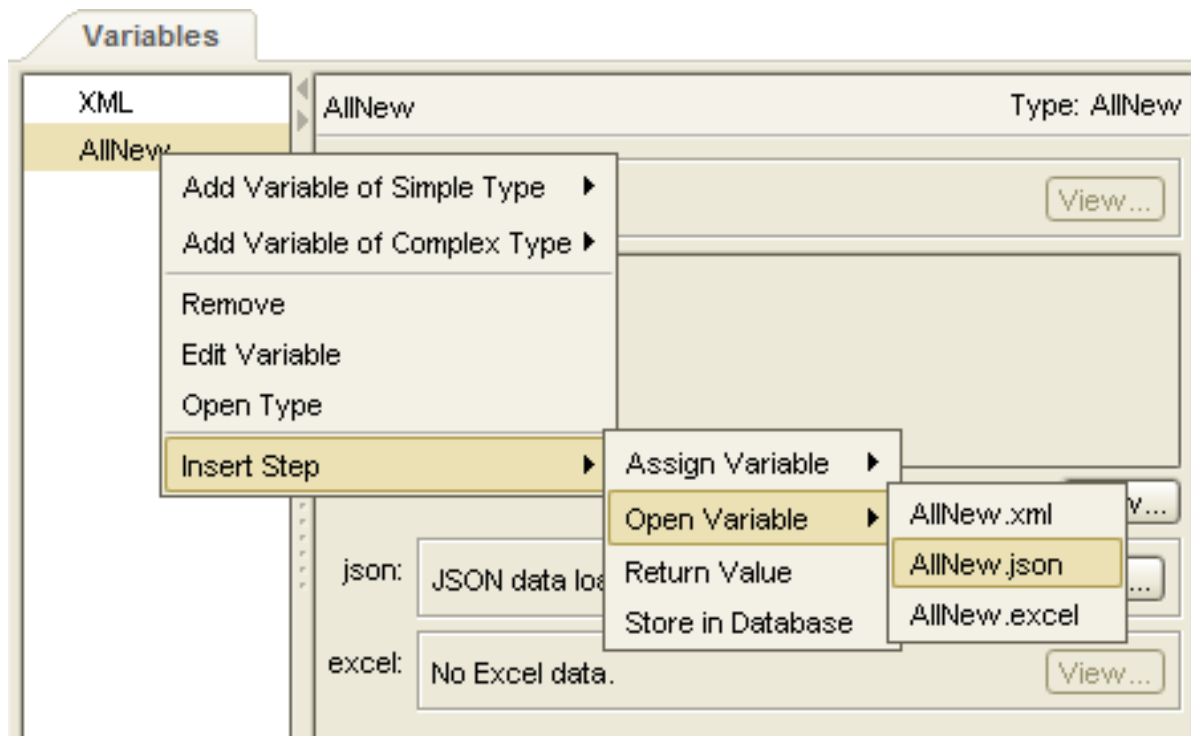

An Open Variable step is inserted in your robot before the current step.

3. Right-click the variable and insert a step action to operate on the variable.

Modify a Variable

You can modify XML and JSON variables. Both variable types have a range of dedicated step actions that may be used to modify them. For example, the Set Attribute sets the value of an existing attribute or adds a new attribute to an XML tag, the Set Property Name step action changes the name of a property on a JSON object, etc. You can also modify a variable by using a step action that operates directly on the variable, such as Assign Variable. In that case, the view will reflect the changes.

Step actions that modify XML variables through the current window:

- [Set Tag](#)
- [Set Content](#)
- [Set Text](#)
- [Set Tag Name](#)
- [Set Attribute](#)
- [Insert Content](#)
- [Remove Tag](#)
- [Remove Content](#)
- [Remove Attribute](#)

Step actions that modify JSON variables through the current window:

- [Set JSON](#)
- [Set Property Name](#)
- [Insert JSON](#)
- [Remove JSON](#)

When a variable of type XML or JSON is shown in the current window, the menu option for inserting the step actions are available in the context menu (right-click menu) in the window. Only those relevant for the given type are shown. Some may be disabled, if the current choice in the view is not relevant. For example, Remove Attribute will not be enabled if the selected tag does not have any attributes.

Work with JSON

JSON (JavaScript Object Notation) is a lightweight data-interchange format that resembles JavaScripts literal notation such as { "x" : 5 , "y" : 7 }.

JSON is a text format, but in robots the JSON structure is represented and viewed similar to the way XML is represented. JSON is treated as its own data format (exactly as HTML, XML and Excel) with its own Page Type. It is not transformed into XML as it was in previous versions of Design Studio. The [Test Page Type](#) step action can verify that the content of the current windows is JSON.

In Windows View, JSON is loaded from a URL or from variables/attributes of simple type JSON. A dedicated view is available to view JSON variables opened in both the Windows View and the Variables View, along with dedicated step actions that work only on JSON.

The following is an example of a JSON text:

```
{ "answer" : 42,
  "people" : [ { "firstName" : "Arthur",
                 "lastName" : "Dent" },
               { "firstName" : "Ford",
                 "lastName" : "Prefect" } ] }
```

JSON Terminology

A JSON text is either an object, { "a" : 5 } or an array e.g. [1, 2, 3]. A JSON value is either a JSON text or JSON Simple type where a JSON Simple type is either a JSON literal, a number, a string. A JSON literal is false, null or true. The literals false and true are called Booleans. A number may be either an integer or a floating point number. There is no limit on the precision or size of numbers, but as soon as they are converted to another representation, the limitation of that representation must of course be respected. For example, if an integer is extracted to an integer variable then the value must be between -2^{63} and $2^{63}-1$; otherwise the extraction step will produce an error. JSON strings must start and end with a double quotation mark (") and may contain any Unicode character except ", \ or control character (these characters may be escaped using \, such as \", \\ and \r. The JSON format is described in RFC 4627 on the <https://www.ietf.org> website.

JSON Syntax

JSON Text = JSON Object | JSON Array

JSON Object = { } | { Properties }

JSON Array = [] | [items]

Properties = Property,Properties

Property = String :JSON Value

Items = JSON Value,Items JSON Value = JSON Text | String | Number | false | null | true

String = "" | "Characters "

Characters = Character Characters

Character = any Unicode character except ", \ or control character | \ " | \ \ | \ / | \ b | \ f | \ n | \ r | \ t | \ u 4 hex digits
Number = a number very much like a C or Java number

JSON MIME Type

The MIME media type for JSON text is as follows:

```
application/json
```

Strictly speaking, not all JSON values are valid for this MIME type. It might be that implementers of services that accept or return JSON may be more liberal and accept and return JSON values. Kapow has chosen to follow this more liberal approach to JSON. To that end, a JSON variable may contain a JSON value and the JSON view can display that value.

When data is loaded from a URL and the MIME-type is application/json, the loaded JSON is shown in the JSON Page View. If this is not the case, you can specify that the data represents JSON. To do this, on the Load Page step, set the Page Content type to JSON. You can also use this method when the data is not loaded from a source where a MIME-type is available, such as in Create Page step action.

JSON and Step Actions

A number of step actions work only on JSON; the data presented in the current window must be JSON (and not JSON in the legacy format where JSON has been translated into XML). These step actions are found in the step action category called JSON in the Step Action Selector on the Action tab of the Step View. But the easiest way to select them is to use the context menu (right-click menu) in the Windows View when the current window contains JSON. See the following sample image.

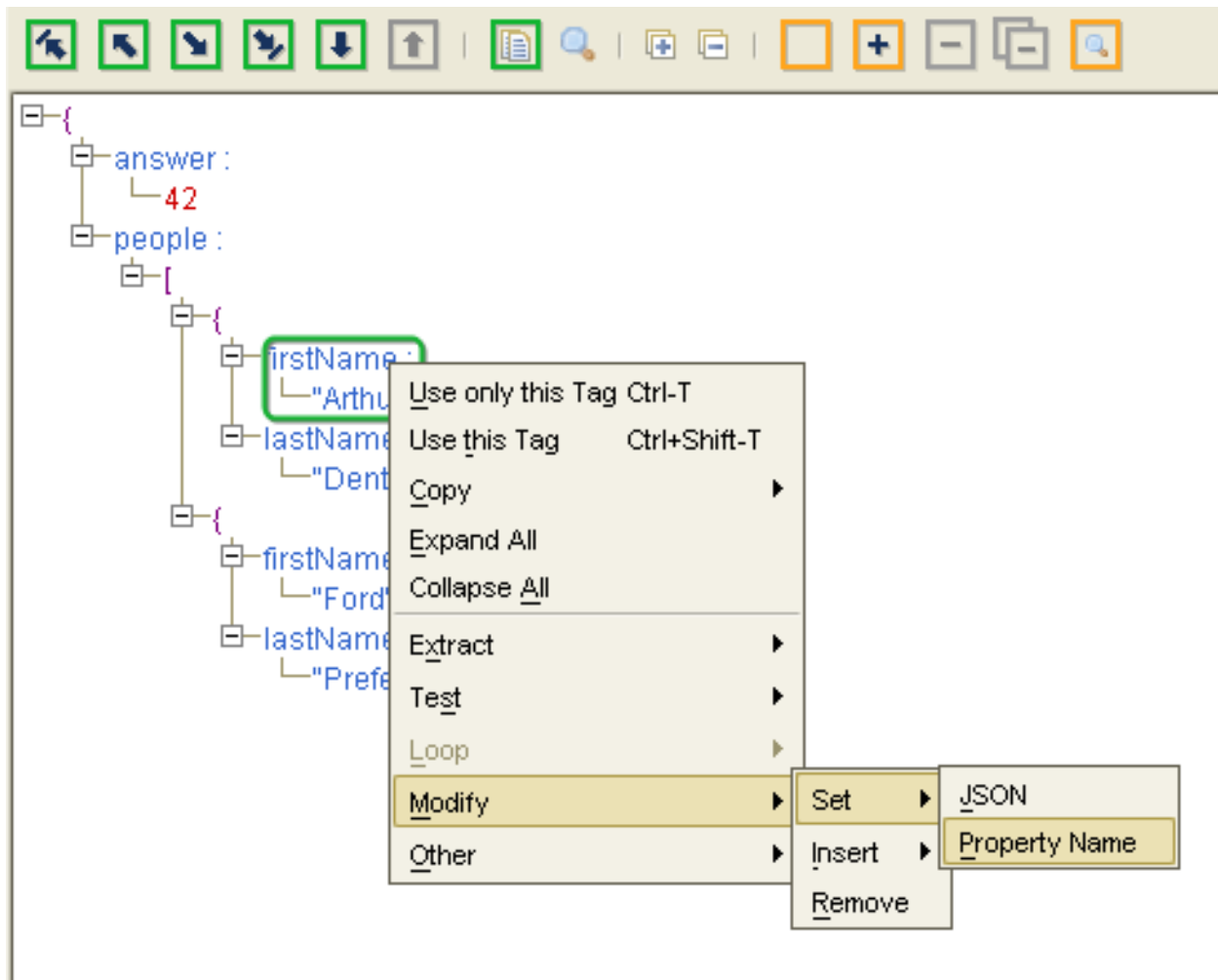

Two step actions can extract from a JSON value:

- [Extract JSON](#). This step action always extracts a JSON value. For example, if the selection in the view is a property, it is the value of the property that is extracted. It is in many ways similar to the Extract step that extracts from HTML and XML, except that it is simpler because of the simpler data format; no distinction exists between markup and text.
- [Extract Property Name](#). This step action extracts the name of a property.

Two step actions can loop over a JSON text:

- [For Each Property](#). This step action loops over each property of a JSON object
- [For Each Item](#). This step action loops over each JSON value of a JSON array.

Both of step actions will for each iteration set a part of the JSON value in question as named JSON (similar to a named tag). This cannot be global when iterating over a variable, since changing the value of a variable during the iteration may change the value in such a way that iteration may fail, such as if an item is removed from the list iterated over.

Four step actions can modify JSON (only if the JSON is in a variable):

- **Set JSON.** Replaces the selected part of a JSON value with a new JSON value.
- **Set Property Name.** Sets the property name to a new name on a selected property.
- **Insert JSON.** Inserts a new property in a JSON object or a new item (JSON value) in a JSON array. There are several options on where to insert the new property or item, such as first or last. Consult the reference documentation for the step action for a full list.
- **Remove JSON.** Removes the selected part of a JSON value, such as a property from a JSON object or an item from a JSON array.

Finally, two more step actions work on JSON:

- **Test JSON.** This step action tests the "type" of a JSON value to determine whether it is an object, array, string, etc.
- **Set Named JSON.** This step action is similar to its corresponding step action for other types of data, such as Set Named Tag and Set Named Range. It defines a named reference to a part of a JSON value so that it can be used as a reference when finding other parts of a JSON value in subsequent steps. Shown as blue boxes in the view.

JSON as a JavaScript Object

Consider a converter stack in a step action that contains a Convert Using JavaScript converter. This converter gets access to the output from the previous converter as a variable named INPUT to use in the JavaScript used by the converter. The value of the INPUT variable is always a String.

The following table shows possible conversion values for the INPUT variable.

INPUT Value	JavaScript (OUTPUT =)	Result (OUTPUT value)
5	OUTPUT = INPUT	5
5	OUTPUT = INPUT + 3	53
5	OUTPUT = eval(INPUT)	5
5	OUTPUT = eval(INPUT) + 3	8
5	OUTPUT = eval(INPUT + 3)	53
5	OUTPUT = eval(INPUT + " + 3")	8
[1,2,3]	OUTPUT = INPUT[0]	[
[1,2,3]	OUTPUT = eval(INPUT)[0]	1
{ "a": 5 }	OUTPUT = eval(INPUT).a	"Syntax Error"
{ "a": 5 }	OUTPUT = eval("var x=" + INPUT + "; x;").a;	5

Note the following when converting JSON to JavaScript:

- INPUT is a variable bound to a string value. Therefore, any operation that you perform on INPUT is a string operation. For example, + is string concatenation. That is why INPUT + 3 becomes 53 in the example above.
- The function "eval" only accepts correct JavaScript as input and {"a":5} is not a syntactically correct JavaScript line, but var x = {"a":5} is, which is why the last example above is the one that works.

Handle Errors

A step in a robot may generate an error when it is executed. For example, this happens if the tag finders cannot find the tag to work on, or if the step action generates an error. You can configure test steps to act as if an error occurred if the test fails. The default behavior of a robot is to report and log the error immediately, and to omit execution of the steps beyond the one that failed. However, by configuring the error handling properties of the steps in the robot, you can change this behavior. For example, you can make the robot skip a step that generates an error, or you can make it try alternative branches.

Note The error handling behavior described in this help system applies to runtime execution of a robot (such as execution in RoboServer or in debug mode), not to the execution in design mode in Design Studio. In design mode, an error is normally reported immediately, and the execution of the subsequent steps is aborted. One exception is when the step is configured to "Ignore and Continue" in case of errors, in which case Design Studio does ignore the error and executes the next step, just as it would during runtime execution.

The following shows how to handle API Exceptions and Logging errors:

1. In the [Step View](#), Error Handling tab, select an error handling option.
 1. Select **API Exception** to report the error back to the caller of the robot. This is most useful when the robot is executed by a client via one of the APIs and runs in RoboServer. In this case the error is sent back to the caller via the API as a RobotErrorResponse, which causes an exception at the caller side, at least when using the default RQLHandler. See the [Error Handling](#) in Reference for the details when the robot is executed in other ways.
 2. Select **Log as Error** to log the error. Logging happens in different ways depending on whether the robot is run in the Design Studio or in RoboServer.

Note You can select or clear the check boxes, which may be marked with an asterisk * to indicate they are set to a non-default value. For details, see [Showing Changes from Default](#), which explains how to remove the asterisk and revert to the default value. When the default value applies (that is, when no asterisk is present), be aware that the default varies according to how the error is handled.

2. In the **Then** field, select an option from the list.

This value defines how and where robot execution continues after an error is encountered. The possible options are described with examples in the following sections. For detailed descriptions, see [the reference documentation](#).

Error Handling Alternatives

You can select several alternative methods to handle errors. See [Conditions and Error Handling](#) for an error handling overview.

Suppose that some part of a web page has varying structure and layout, but always comes down to one of three cases. In each case there is information to extract. It can be done by attempting the extraction one case at a time. If it fails, the next case is tried, until the third one, which we assume will succeed.

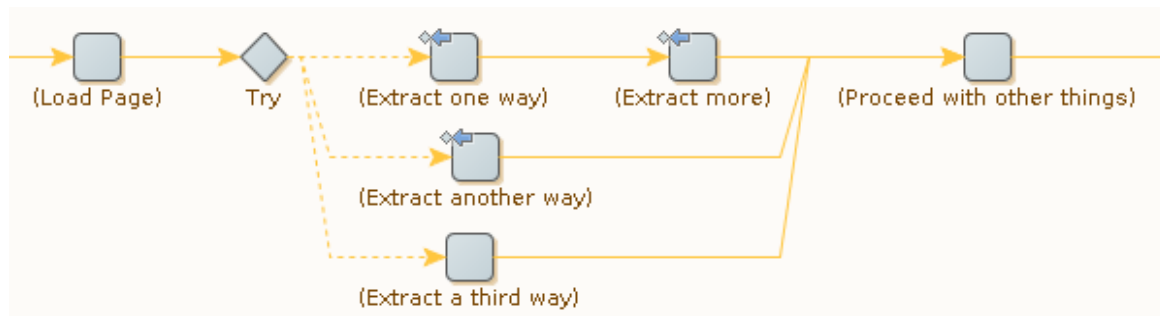

Note the  (Try Next Alternative) icons on the Extract steps. If extraction fails, the next branch from the Try step is executed (if a branch coming out of a Try step succeeds, the next branch is not executed). The Extract steps do two things at the same time: They do extraction from the web page, and if it cannot be done, they ensure that the next approach is tried. Note that if either of the two steps on the first branch fails, the second branch is executed; this is an example of how the "success condition" for a branch can be expressed by a combination of steps.

This approach works best if the "third way" of extracting is bound to work (for example, by applying a fixed set of default values rather than actually extracting data from the web page). If the third branch accesses the web page as the first two branches do, it may not be wise to assume that it will succeed. The next time the robot is run, the web site may have changed so much that none of the three strategies succeeds, and the robot should be able to respond in a reasonable manner.

The easiest way to respond is to report the problem back to the caller and log it, giving up on doing the extraction and whatever would follow. This can be achieved by making the third branch inform the Try step if it fails to do its work, similar to the first two branches.

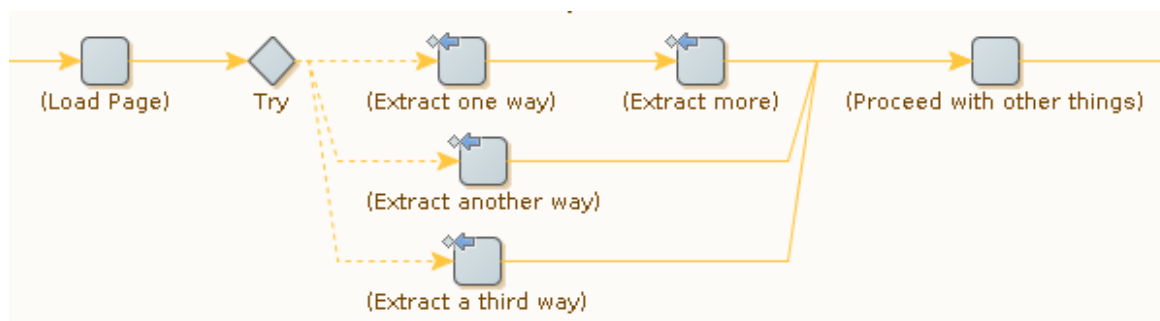

(For a Try step, **Skip Following Steps** means that no additional action is taken beyond reporting and logging.)

Alternatively, it is possible to make the Try step propagate the problem back to an earlier Try step for handling. For more information, see [Try-Catch](#).

Shortcuts for Common Cases

Try steps and Try Next Alternative error handling are very flexible tools. Used in the proper way, they support many different ways to handle errors, and in this topic, we will show a couple of simple and common cases. In fact, these cases are so common that they are also supported by specialized error handling options.

Skip Following Steps

In many cases, a robot must be able to handle optional elements on a web page. That is, if the elements are present, they must be handled (for example, data must be extracted), but if they are absent, the handling of elements can be skipped. Their absence is not an error, but an expected situation. This can be expressed as follows in a robot. Step A tests if the elements are present (by trying to extract something), while steps B and C do further processing that depends on the success of step A.

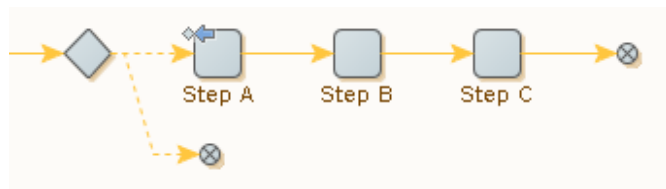

If step A is not successful (because elements are missing on the web page), its Try Next Alternative (⊞➡) error handling sends notice to the Try step (which is unnamed in this example). This causes the second and empty branch to be executed, after which execution of the whole branch that starts in the Try step is done. Thus steps B and C are not executed if step A is not successful.

This situation happens so often that a specific error handling option, Skip Following Steps, is introduced as a shortcut. It makes it possible to simplify the example as follows.



The error handling for step A is configured as follows. This is the default configuration for all new steps.

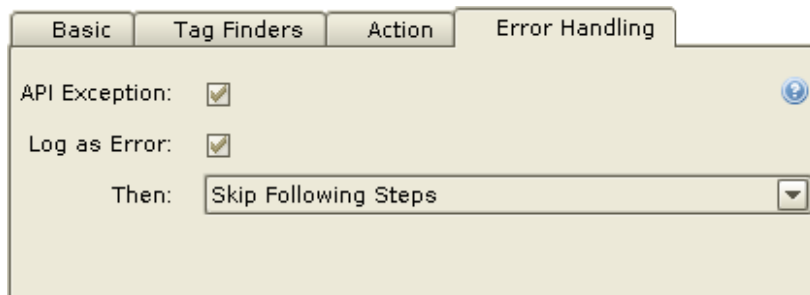

Strictly speaking, you need to clear the **API Exception** and **Log as Error** check boxes to get exactly the same behavior as shown with the Try step. This is because the default values for these check boxes are different for the two ways to do error handling.

Note that if step B had been similar to step A (that is, if step B had also had Try Next Alternative error handling), this same shortcut could be used.

Ignore and Continue

Sometimes, some action (such as extraction) needs to be done if some condition is met, and otherwise it can be skipped. Subsequent steps do not depend on the result (or a proper default for the result has been set up in advance). This case can be expressed as follows.

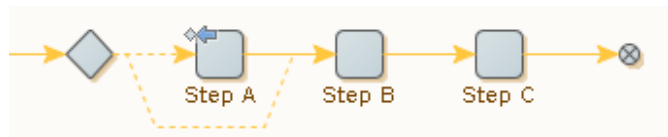

If step A is not successful, its Try Next Alternative (◊➡) error handling causes the second and empty branch from the (unnamed) Try step to be executed. After this, execution continues at step B with the same robot state that was input to step A, thus step A is effectively skipped.

This can also be done without the Try step by using the error handling option **Ignore and Continue** (➡) on step A.



One interesting possibility is to have the situation logged even though it is otherwise ignored. This can be achieved by configuring error handling on step A as follows.

Basic	Tag Finders	Action	* Error Handling
API Exception: <input type="checkbox"/>			
Log as Error: * <input checked="" type="checkbox"/>			
Then: * Ignore and Continue			

The same can be done if you prefer to use the method with a Try step.

At Target

By its very nature, Try Next Alternative error handling refers to a Try step. This Try step must be a prior step on the [current execution path](#), that is, it must be one of the steps whose execution led up to the current step. Otherwise the "next alternative" part of Try Next Alternative does not make much sense.

Consider a robot with several Try steps on the current execution path. In this situation, the robot will be in the process of executing a "current branch" relative to each of these Try steps, and for each of them the "next branch" is different. For example, in the following robot, if an error occurs in step B, Try Next Alternative continues execution using one of the following approaches.

- The next branch at the rightmost Try step, so that execution skips step C and continues at step D
- The next branch at the leftmost Try step, causing execution to skip both steps C and D and continues at step E

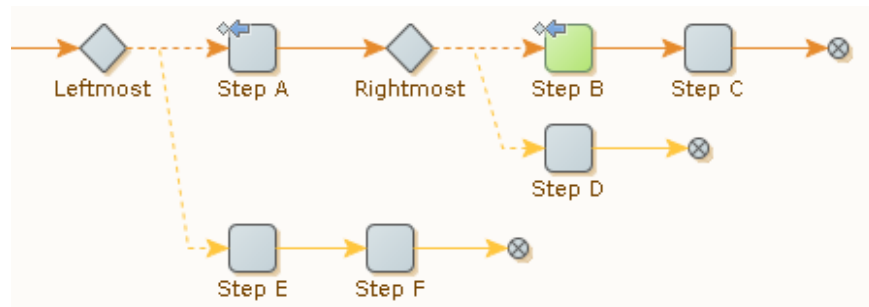

You can define the option on the Error Handling tab. The following example shows the error handling configuration for step B.

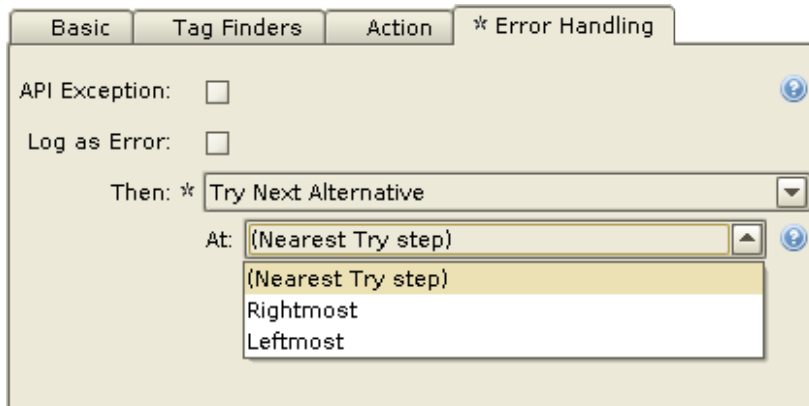

The default is the Nearest Try step, but you can select other Try steps on the execution path. The reference to the Try step is by name; if several Try steps have the same name, the nearest (rightmost) one with that name is implied. This can be used to advantage as described in [Try-Catch](#).

While this example only describes At targets in relation to Try Next Alternative error handling, you can use such references with the Next Iteration and Break Loop error handling options described in [Looping](#). In those cases, the references go to loop steps rather than Try steps.

Looping

Sometimes when an error occurs or a test fails, the proper reaction is to abandon execution of the current iteration of a loop, or the whole loop. This is supported by two specialized error handling options.

Next Iteration

In the following robot, step B has error handling for Next Iteration. If an error occurs during execution of this step, execution of the current loop iteration is stopped. Steps C and D are not executed; instead execution continues at step A with a robot state that reflects the next tag among those that the loop step iterates over.

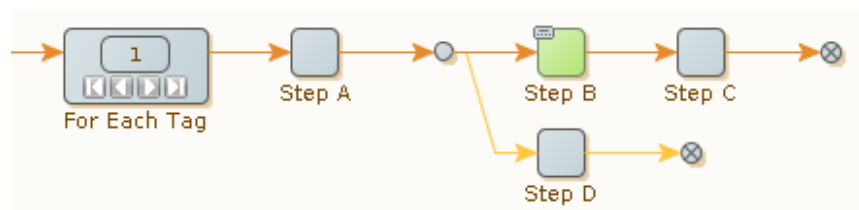

This error handling option is a shortcut, as you can achieve the same effect with the aid of **Try Next Alternative** and a Try step.

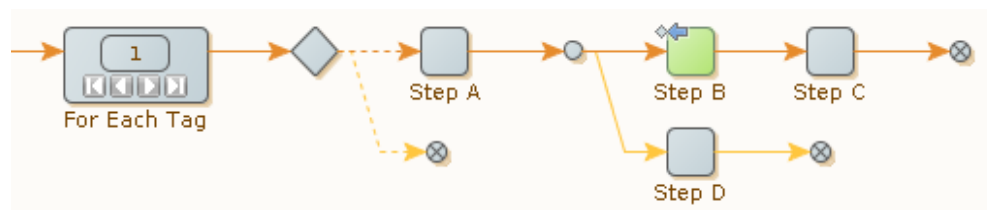

Note that this transformation in general requires use of [At Targets](#) because other Try steps may interfere. If the robot contains several loops steps after each other, it is possible to select the one in which to go to the next iteration.

Next Iteration does not work with Repeat-Next loops. The word "next" has very different implications for the browser state in these two cases.

Break Loop

Instead of completing a single iteration of the loop with Next Iteration, you can use Break Loop to abort the whole loop.

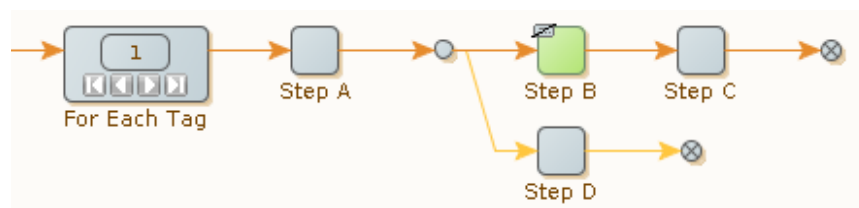

This error handling option is a shortcut. The following robot will have the same effect:

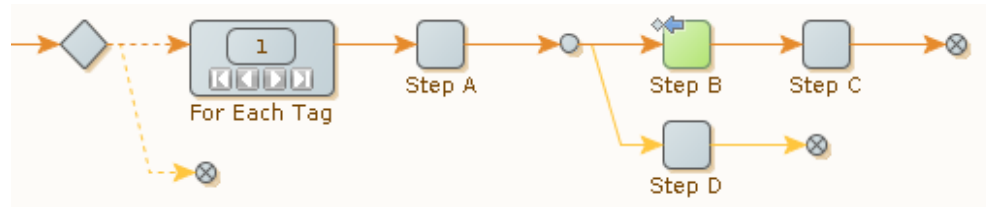

Note that unlike Next Iteration, Break Loop does not work with Repeat-Next loops.

Try Catch

When Try Next Alternative error handling is used with an explicit **At** reference to a [target Try step](#), the step is identified by its name. Most often, the fine distinction between the target step and its name is not important, but it can be exploited to provide exception handling functionality similar to the try-catch constructs in Java or C#.

In those programming languages, a section of code between "try" and "catch" has special error handling. If a specific error is signaled within this section (by "throwing" a named "exception"), the piece of code following the similarly named "catch" is executed. Try-catch constructs can be nested, and a named "exception" is always handled by the innermost enclosing "catch" with a matching name. For example:

```
try {
  ... code ...
  try {
    ... inner code ...
    throw new E(); // caught by innermost "catch"
  }
  catch (E e) {
    ... inner handling code ...
  }
  ... more code ...
  throw new E(); // caught by outermost "catch"
}
catch (E e) {
  ... outer handling code ...
}
```

In robots, something similar can be done with Try steps. Remember that an "At" reference to a Try step with a given name always means the nearest prior step with that name (along the [current execution path](#)). It is permitted to use the same name for several Try steps, even on the same execution path. Thus each try-catch construct is modeled with a Try step having the same name as the "exception." The Try step has two branches: one for the code part of the "try" construct, and one for the code part of the "catch" construct.

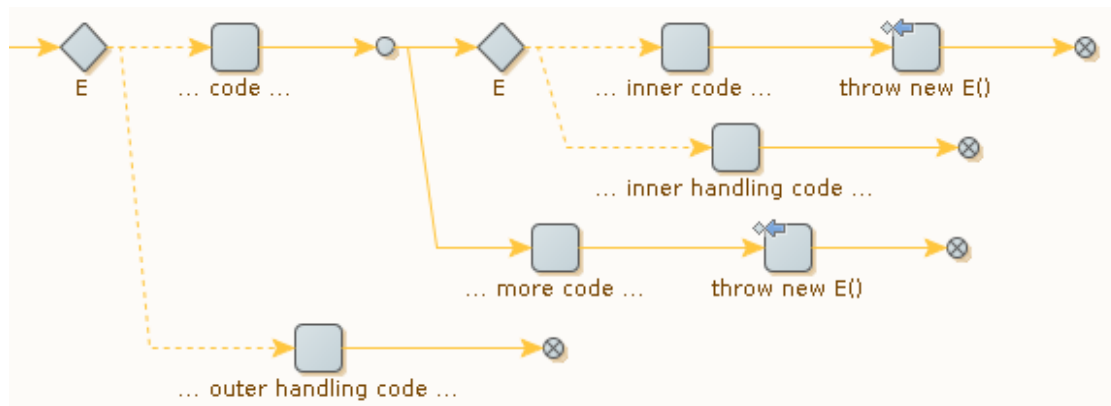

The correspondence between the Java/C# syntax and the Design Studio terms is described in the table.

Java / C# Syntax	What to use in Design Studio
try { ...code... }	The first branch of a Try step (the steps correspond to code)
Name of an exception	Name of a Try step
throw new E() within the code of a try	Handling an error with "Try Next Alternative at E"
catch E { ...code... }	The second branch of a Try step named "E" (the steps correspond to code)

Thus, the core idea is: When Try steps are used for error handling, name the Try steps after the error situations they handle. The advantages are:

- The naming helps make the purpose of each Try step clear.
- When errors are handled on a general level (with a Try step more to the left in the robot), it is still easy to do specialized handling in some cases (with the aid of a second Try step with the same name).

Identify Error Handling in Robot View

Robot steps containing special error handling are marked with a small symbol in Robot View. The symbol is based on the type of error handling defined for the step to help users visually identify steps containing custom error handling. If you do not want to have steps with custom error handling marked, you can disable this feature on the **Options** menu in the Design Studio.

See [Robot Editor](#) for more information.

Create and Reuse Snippets

A snippet can be created in three ways.

1. From a selection of steps:
(must be steps that can be grouped and not a single Group step)
 1. Select one or more stems and click **Create snippet from selection** .

2. Enter a name for the new snippet.
 3. Create a snippet of that name containing the select steps.
 4. Insert a new Snippet step instead of the selected steps.
2. Turn a group step into a snippet step:
 1. Select a Group step and click **Convert group to a snippet** .
 2. Enter a name for the new snippet.
 3. Create a snippet of that name containing the group steps.
 4. Insert a new Snippet step instead of the selected Group step.
3. Create a snippet from a new snippet:
 1. On the File menu, select **New Snippet**.
 2. Enter a name for the new snippet.

An empty snippet appears in your project and the Snippet editor opens.
- Note** You cannot edit the snippet contents (the steps inside the snippet) inside this editor,
3. Edit the description and referenced variables list as needed.

Variables and Snippets

Just like steps anywhere in a robot, the steps in a snippet can use variables. The steps of snippets are always edited inside a robot. In that context the variables defined on the robot can be used in the snippet. Reusing the snippet in another robot requires you to define the variables used by the steps in the snippet on each robot that uses the snippet.

A snippet can define its own variables. Open the snippet in its own editor to define variables on the snippet. If the snippet already contains steps using variables that existed in the robot where the snippet was edited, the steps are marked with a red flag.

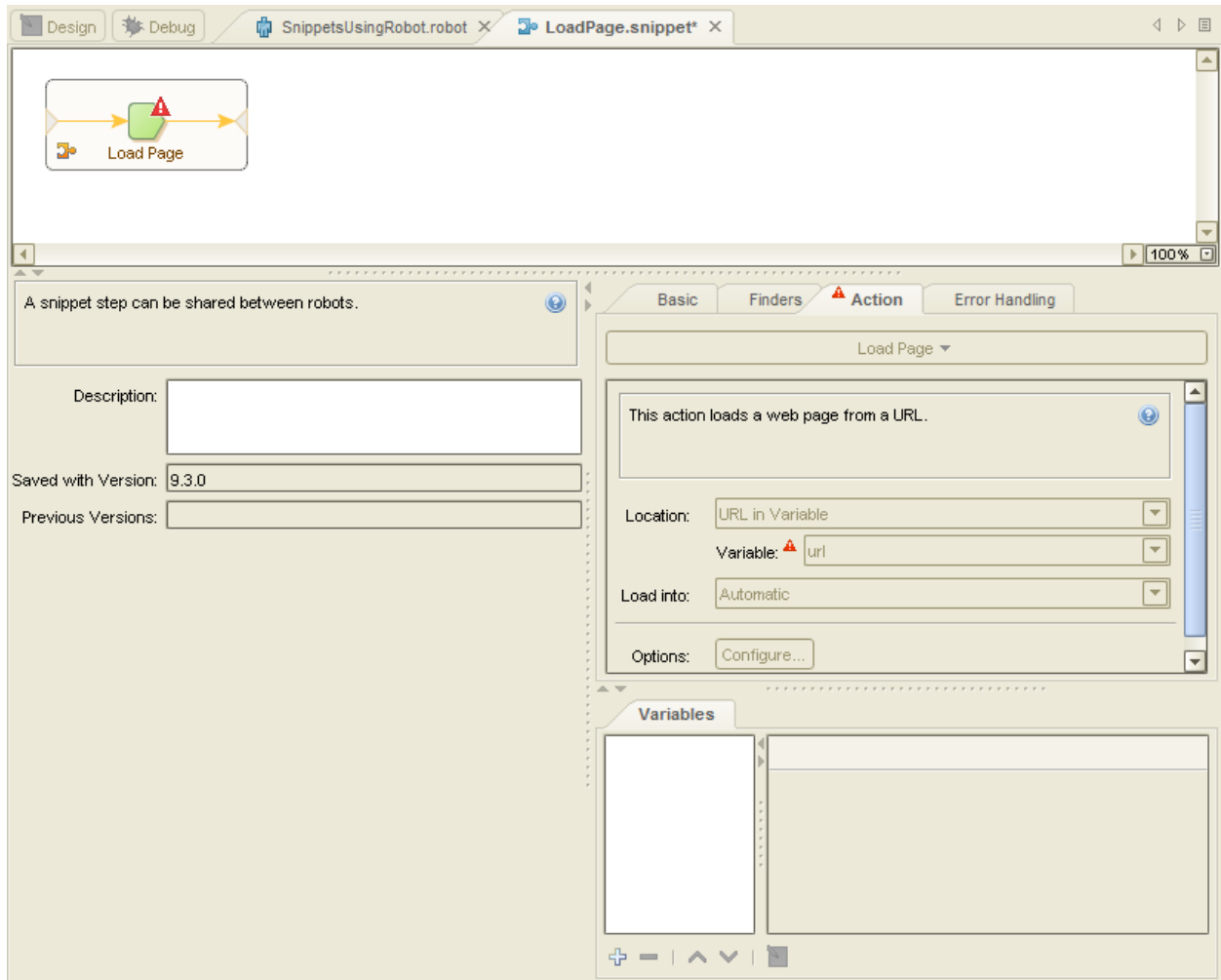

The preceding image shows a snippet in its own editor, that uses a variable not defined on the snippet itself.

Notice the active variables editor in the lower right corner, exactly as on robots.

If a snippet defines variables, using the snippet in a robot automatically adds the snippet variables to the set of variables for the robot.

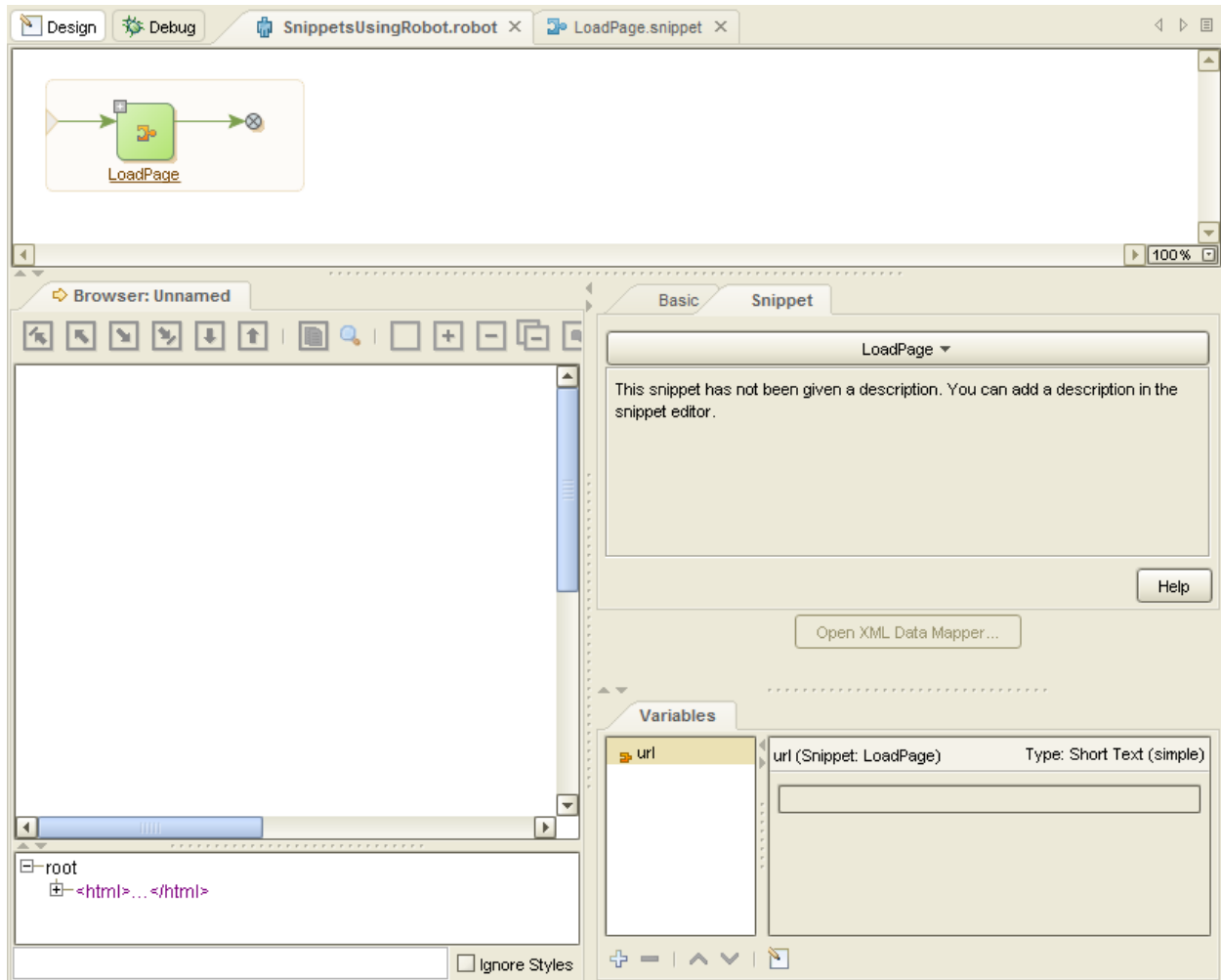

The preceding image shows a robot that uses a snippet that defines a variable 'url'.

Notice the variables imported from snippets are marked in the variables list.

A robot should not contain variable definitions by the same name as variables defined in the snippets it uses. If it does, the variable types must match.

Removing a snippet from a robot also removes the variables imported by that snippet.

Snippet Best Practices

Consider the following snippet best practices.

- Put the non-default robot configuration used to execute the steps inside the snippet, on the steps of the snippet. This way you do not need to remember to set them on each robot using the snippet.
- When inserting a snippet into a robot, take care that names of variables defined on the snippet do not conflict with variables defined on the robot. Design Studio cannot handle a situation where a variable defined on the snippet has the same name as a variable defined on the robot. It is a good practice to

define variables on the snippet when they need to work in another context. This makes reuse of the snippet easier.

- In the snippet description, document the context in terms of named tags and/or windows required by the snippet.
- Use caution when including snippets inside snippets. A snippet may contain snippet steps referencing other snippets. However, a snippet cannot contain a circular reference (such as a cyclic reference where the snippet contains itself). If a snippet contains a circular reference, Design Studio reports an error.

Make Robust Robots

Web sites often change without notice. Such changes may result in the robot failing to do its task, unless you are careful. Robustness is the term used to describe how well robots cope with web site changes. The more changes the robot can deal with (and still work correctly), the more robust it is.

Robustness, however, comes at a price. It is more challenging and time-consuming to write robust robots than to write shaky robots. It involves analyzing the web site in question, and understanding how it responds in various situations, such as when a registration form is filled out incorrectly. In a sense, writing robust robots involves a kind of reverse engineering of the web site logic, and usually the only way to do this is through exploration.

The two different approaches to robustness each serves a different purpose:

- Succeed as much as possible.
- Fail if not perfect.

Succeeding as much as possible might, for a robot extracting news type variables, mean that it should extract as many news items as possible. In Design Studio, you use conditional actions, Try steps, and data converters to deal with different layouts, missing information, and strangely formatted content.

Failing when things are not perfect might, for an order submission robot, mean that it should fail immediately if it cannot figure out how to enter a field correctly, or the order result page does not match an exact layout. In this sense, failing does not mean to generate an API exception. Instead, it means that the robot should return a value dedicated to describing errors and failure causes. Robots taking input variables often fail, rather than succeed as much as possible. In Design Studio, you can use dedicated error type variables, error handling, and conditional actions to detect and handle unexpected situations.

For more information on Design Studio techniques to make robots more robust, consult the following sections: [Extracting Content from HTML](#), [Extracting Content From an HTML Table](#), [Handling Errors](#), and [Using Tag Finders](#).

Reuse Sessions

A session is the result of browsing on a website, and consists of the page, the page URL and the cookies and authentications obtained in the course. However, obtaining a session where the desired information is easily reached can require a number of navigation steps such as logging in.

If a robot is run frequently enough, and the response time needs to be very small, getting to a suitable session in the robot can require more time than is available. However, if the session is obtained once, and then shared between robots and robot runs, then great time savings is achieved.

Two step actions are used for session reuse:

1. The Save Session action: Saves a session in a variable.
2. The Restore Session action: Restores a session from a variable.

Example

Assume that we have a robot that logs in to a web site to collect and return data. However, the data that we seek to collect is distributed over many linked pages, such as with a next page link. We want the first invocation of the robot to log in to the site and return the data of the first page, and each subsequent invocation should then return a new chunk of data (the next page). We want to share the session of a logged-in user between robot invocations, but we also want to remember how much data we have returned. The robot could look something like the following example.

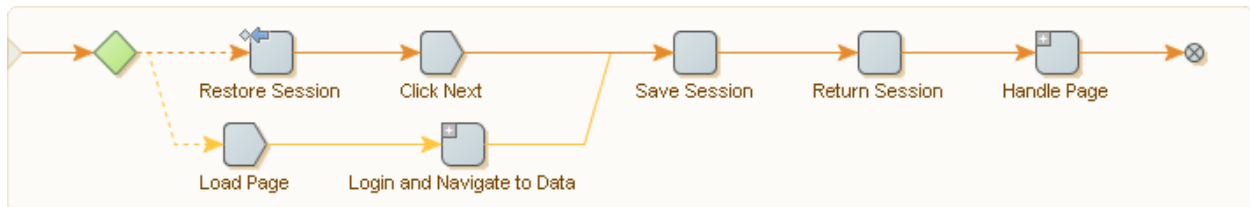

When the robot is called, it will first try to restore a session from an input variable. If one exists, that session is used and the next step clicks a next page link to get a fresh page of data. If no session is passed to the robot, the step fails, and the second alternative is executed, which does the logging in and also navigates to the relevant page on the site where the data may be found.

If the robot execution gets through one of the two alternative branches, it reaches the Save Session step. This saves the session to use the next time the robot is called. But for this to be possible, we need to return the session to the caller of the robot. This is handled by the Return Session step, which is a normal Return Value step that returns the value of a variable containing the session (the variable is of a type that has an attribute of attribute type Session in which our Save Session step stored the session). Finally, if the robot reaches the end of the data (no next page link exists on the page), then the Click Next set produces an error. This is ignored by the robot, because we set Error Handling to Skip Following Steps, but if we have a check mark in API exception, the caller would get an exception. For example, if the robot is called from Java, uses the check mark to know that the end of data has been reached.

After the session is saved, the remaining steps of the robot extract the data from the page, such as by looping over a table and returning a value for each row.

Note that in Design Studio, robot execution is not controlled by the natural flow of a robot run. It is controlled by the user interaction.

1. To store the session, select the step following the Save Session step.
2. Select the Restore Session action.

Modify an Existing Type

If you need to change a type after writing robots using variables of that type, be cautious. Your robots might stop working if you do something wrong.

You should take care when performing any of the following changes to a type that is already used by variables in existing robots; otherwise, you cannot use those variables (however, the robots may still be loaded without the variables):

- Change the name of a type.
- Delete a type.
- Remove or rename an attribute in a type if, in a robot, one or more variables of that type have assigned values different from the default for that attribute.
- Change the attribute type of an attribute if, in a robot, one or more variables of that type have assigned values that are not compatible with the new attribute type.

If your robot is open while you make any of the preceding changes, you see a red status bar at the top of the Robot Editor with a text explaining the problem. The status bar also contains a button that you can click to reload the robot with the compromising variables removed. You can also solve the problems by making the appropriate changes to your types. If you do this, you can return to your robot and continue working.

The following changes to a type can be automatically carried over to robots without having to remove any variables of that type (you may have to reload), but some errors might be generated when the robots are executed (you can subsequently fix the errors):

- Change the name of an attribute.
- Change the Required property of an attribute from false to true.
- Add a new attribute that has the Required property set to true.
- Delete or rename an attribute that is assigned a value in a variable.
- Change the attribute type of an attribute that is assigned a value in a variable.

You can always make the following changes, without affecting existing robots:

- Change the Required property of an attribute from true to false.
- Change a comment (no matter where).
- Add a new attribute that has the Required property set to false.

Configure Robots

1. On the Design Studio toolbar, select **Configure Robot** . You can also select Configure Robot from the File menu.
The Robot Configuration window appears.
2. On the Basic tab, click **Configure**.
3. Configure default options that apply to all step actions of the robot.
A step action can override global options as needed.

4. Click **OK**.
5. In the Robot Comment field, enter an optional comment.
This comment is useful if you want to document how the robot works, what should be taken into account when editing the robot, etc.
6. On the Advanced tab, you can specify an optional proxy server to use for all page and data loading performed by the robot.
This property is used infrequently. Typically, it is better to specify one or more proxy servers under Design Studio settings. See [Proxy Servers](#) for details. The proxy server specified for a particular robot overrides proxy servers specified any other way. Furthermore, you can use the [Change Proxy](#) action to change the proxy service during robot execution.

Show Changes from Default Robot Configuration

At times it is difficult to see non-standard parts of a robot configuration. For example, a Page Load step might be assigned a longer timeout than the default value of 60.0. To investigate the non-standard configurations, you may have to navigate through Design Studio to locate a property that is changed from the default setting. You would also need to remember the default values for all the properties.

In Design Studio, you can use Show Changes to avoid these manual steps. Properties with a well-defined default value are marked with an asterisk * next to the property name if the value is changed, as shown in the following figure.

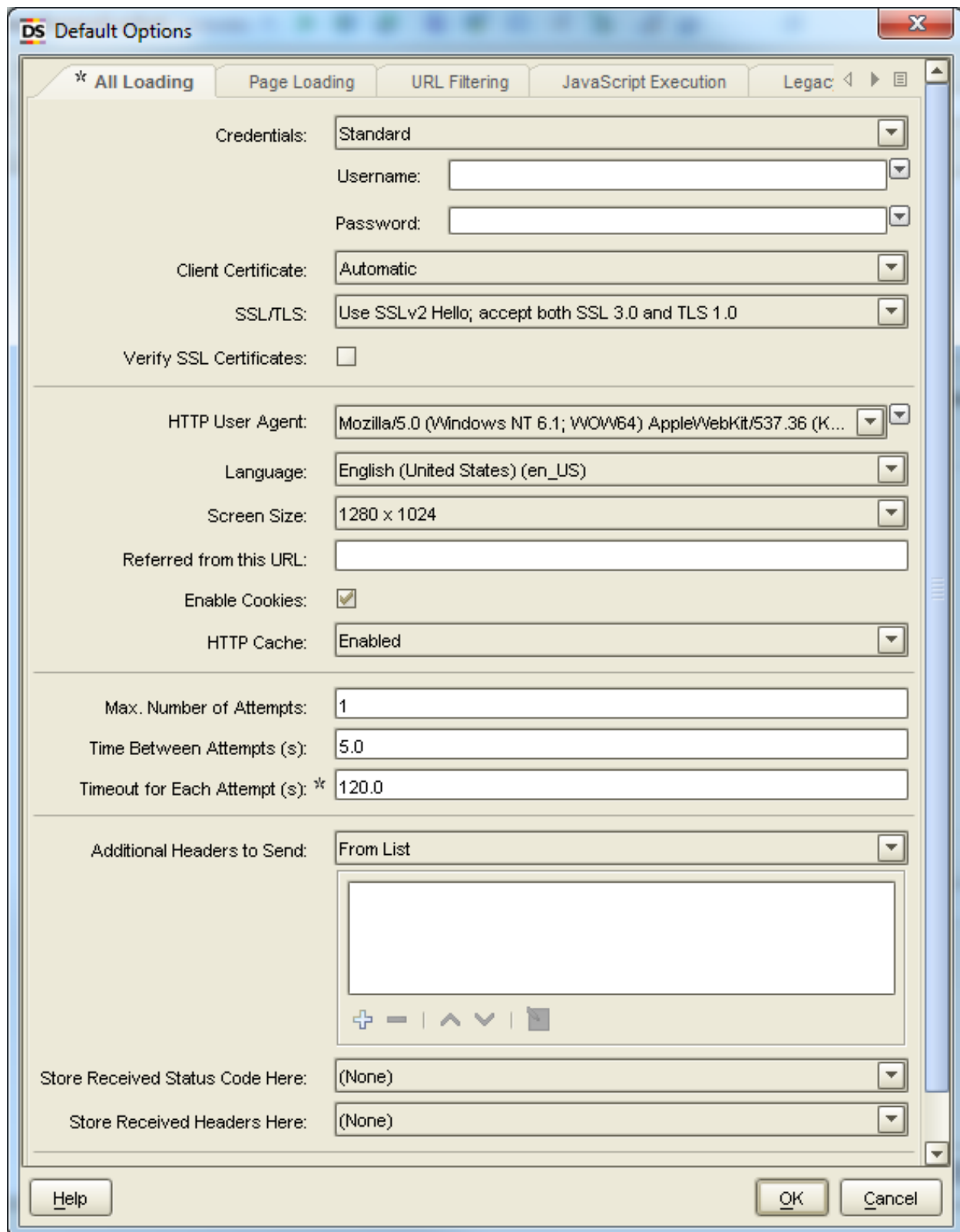

Notice that the tab also displays an asterisk. This indicates that some property on the tab is changed.

Right-click the property name or the asterisk to reset the value to its default. The context menu typically displays the default value.

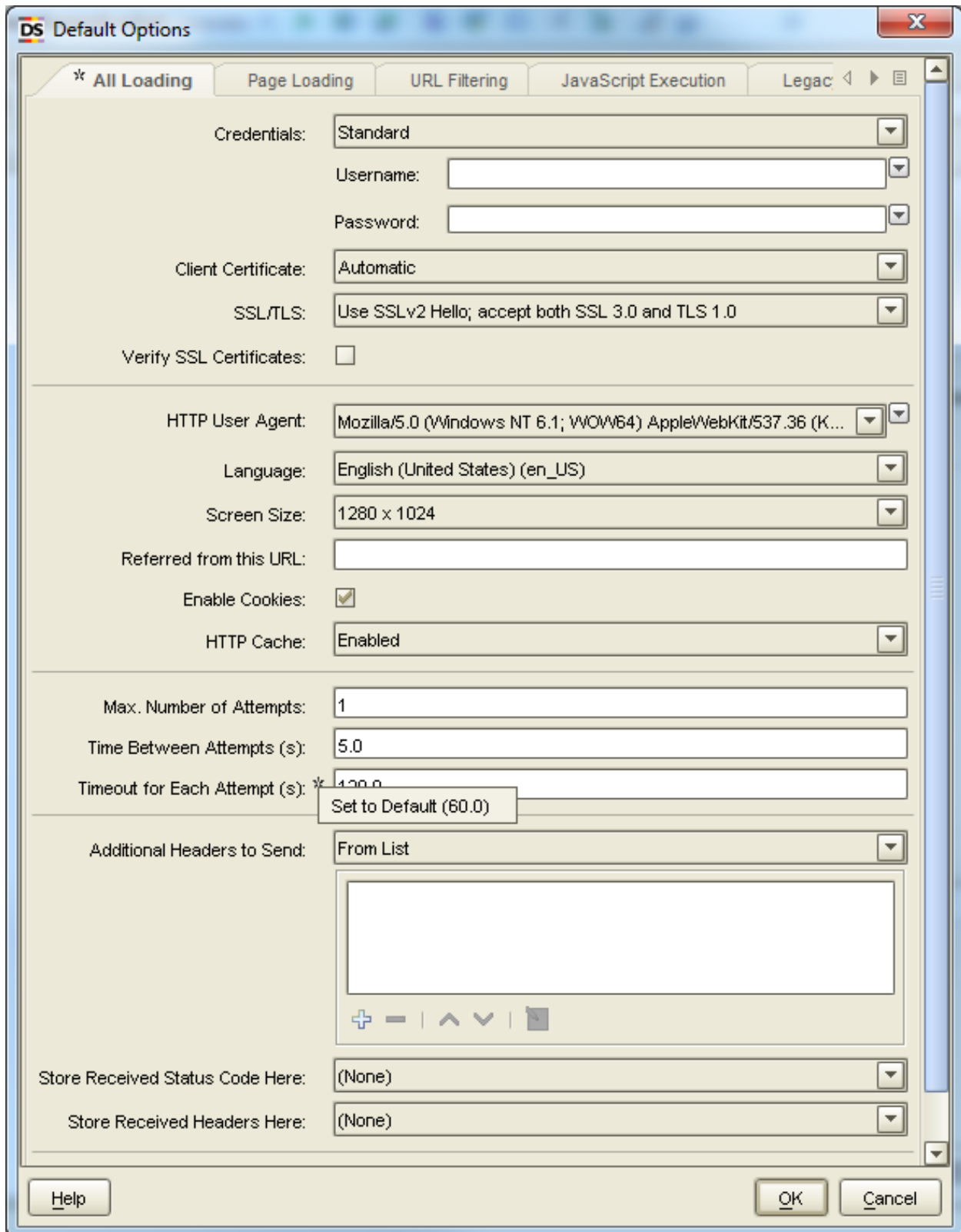

The preceding figure shows the Timeout for Each Attempt property on the Options dialog box.

Show Changes works differently on the Options window when it is used to configure step options. You can generally configure options in two places:

- From the Robot Configuration
- On steps that may depend on these options

In both places, you click a button to open the Options window to configure the options, but the default value is different for each situation. If you open the window from Robot Configuration, the default is a fixed application default, which displays the values provided by Design Studio. If you open the window from a step configuration, the default is the one defined under Robot Configuration (robot default). That is, a step inherits the option values from the robot configuration unless they are explicitly changed for the step. For example, if the option "Enable Cookies" is cleared in the robot configuration, all steps that depend on this option also use this setting unless you have explicitly changed them for the step. An asterisk on a step option indicates the step uses a value different from the one defined in the robot configuration, which is not necessarily different from the application default.

There is another way in which an asterisk on the step's Options dialog has a different meaning than on the Robot Configuration's Option window. For options on the step's Option window, an asterisk means that the given option is deliberately set to a fixed value, which is not necessarily different from the corresponding Robot Configuration value. Also, the value is not influenced by any changes in the corresponding Robot Configuration value. For example, if initially the Timeout for Each Attempt property for a step is set to 120 and the corresponding value under the Robot Configuration is 60, an asterisk appears next to the option. If the Robot Configuration value is changed to 120 so that the two values are actually the same, the step's value is still marked with an asterisk. If the value for the robot is again changed from 120, the value for the step stays unchanged at 120. If you change the step's value back to its default value (the value from the Robot Configuration) using the context menu or double-click, the step's value uses the Robot Configuration value and subsequently follows any changes made.

Another situation where the default value may depend on other configuration choices applies to [error handling](#) step configuration.

Migrate a Robot to a Different Browser Engine

Kapow uses a browser to interact with web sites or web applications. Kapow currently comes with two different browsers, each optimized for different purposes: the Classic engine for legacy web applications and the Default (Webkit) engine for modern web applications. However, these browsers might not be compatible with every internal application or Internet web site. If you encounter problems using any of the browsers, you can migrate your robot to other browser type in the Design Studio using the following procedure.

Migrating a Robot to the Classic Browser

1. Right-click a robot in the tree view and select **Migrate**.
2. Select files that you want to migrate, such as robots and snippets and click **Next**.
3. Specify whether to backup your files, select the backup method and click **Finish** on the Backup step.

After Kapow migrates your robot, you can see that the color of the robot icon has changed.

Note When migrating a Webkit robot that has steps with legacy waiting criterion, this waiting criterion is converted to "Wait real time for timer events" and "Max wait for time out."



Migrating a Robot to the Default Browser

1. Right-click a robot in the tree view and select **Migrate**.
2. Select files that you want to migrate, such as robots and snippets and click **Next**.
3. Specify whether to backup your files, select the backup method and click **Finish** on the Backup step. After Kapow migrates your robot, you can see that the color of the robot icon has changed.

Note When migrating a robot from the Classic to the Default browser engine, the robot is checked for the "Wait real time for timer events" or "Max wait for time out" settings in the robot configuration. If the settings are found, Design studio shows a warning that these configuration settings will be lost during the migration. This is applicable only to the robot configuration. If any step has the "Wait real time for timer events" or "Max wait for time out" settings, they will be converted into a legacy waiting criterion.

Configure Variables

When creating a new robot, you usually start by configuring its variables. Of course, you can reconfigure the variables at any time during the robot's lifetime, such as changing the initial value of a variable.

1. In the Robot Editor, below the Step View, select **Variables View**.
The variables you specify become part of the robot state given as input to the first step of the robot. The Variables View shows a list of variables, together with details on the selection. The icon next to the variable indicates the variable type as follows:
 - Input Variable 
 - Global Variable 

The following Variables view contains three variables: one input variable, one normal variable, and one global variable.

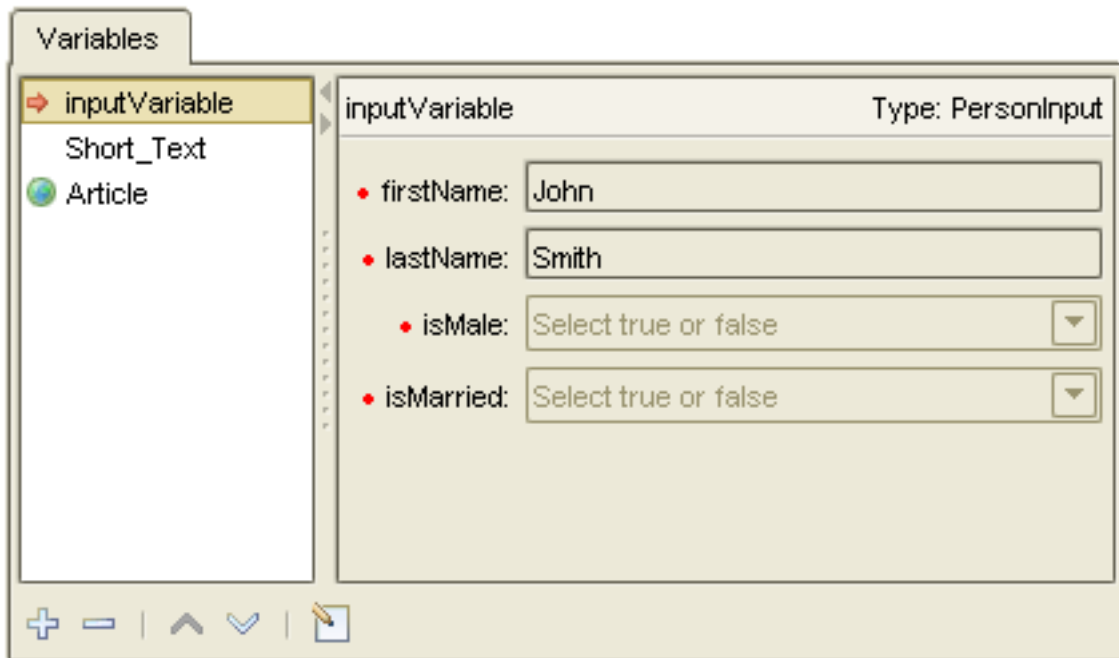

The Variables View shows the values of the variables at the current step. Because these values result from the execution of the robot, you cannot change them directly. However, you can add or remove variables.

2. To add a new variable, click **Add** , or right-click the Variable and select a type.

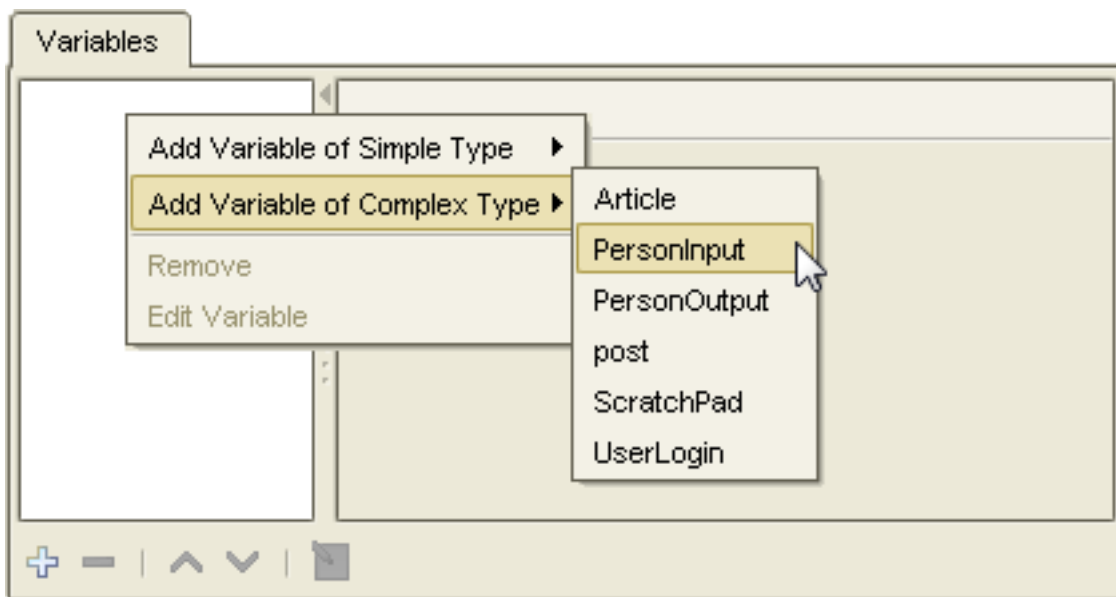

The Edit Variable window appears.

Note If the variable is added using the right-click method, where a type is already selected, the window opens with the pre-selected type.

Note This is also the window used to configure an existing variable, either by double-clicking it or by clicking the  button.

3. In the Edit Variable window, enter a name for the variable.
The name must adhere to naming standards. For example, spaces are not allowed. When you click OK, you are notified if the name is invalid. Change an invalid name or click **Cancel**.

Note Use the variable configuration window to edit initial values. In other words, this dialog box does not, as the Variables view, show current values. The values you provide are used at the start of the execution.

4. Select a variable type.
See [Variables and Types](#) for more information about types and their connection to variables.
5. Complete the input fields based on the type.
Use these fields to provide the variable with initial values. You do not have to manually give the variable a name.
6. Click **OK**.
If you have not entered a name, you are prompted to generate a name from the type name.
7. Use the **Global** and **Use as Input** check boxes to configure a variable as input to the robot or global.
If a variable is used as input, it makes it possible to supply the robot with values for that variable when running it on a RoboServer. For input variables, the values entered for attributes should be regarded as test input and used only when you are working with the robot in Design Studio. When the robot is run on RoboServer, the input values are overridden (replaced) by values supplied by the client that runs the robot. Note that variables of simple types cannot be used as input, as their usage is as temporary variables, which are internal to the robot.
8. If you want the variable to keep its value during the entire robot execution, select **Global**.
Global variables provide a way to create counters and do other kinds of computation across iterations and branches. Global variables can also be used for accumulation of data across iterations or branches, such as accumulating a text consisting of comma-separated values.
This is different from normal variables, whose values are not kept across loop iterations and branches.

Note In Design Studio, the values of the global variables depend on which steps you have executed to get to the current step. Unless care is taken to execute the right sequence of steps, the values are different from when the robot is actually executed.

9. To remove a variable, right-click the variable and select **Remove**.
Alternatively, select a variable and click **Delete**  below the list.

Use Device Automation

Requires a Desktop Automation License.

Use in Smart re-execution mode.

Device Automation is wrapped in a step inside a website robot to enable you to run it in the Management Console, or as a Kapplet, or as a service. Also, using Device Automation as a step in a robot gives an opportunity to combine it with a website robot and transfer data between Automation Devices and websites.

Device Automation Workflow

A Device Automation workflow may consist of the following parts.

1. Install and configure Device Automation on remote computers. See [Configure Device Automation Agent](#).
2. Create an Automation Device mapping in the Management Console. See [Map Automation Device](#)
3. Create a robot in Design Studio.
4. Run a robot to automate the devices.

Note When automating terminal computers, do not install Automation Device Agent and do not create an Automation Device mapping.

Configure Automation Device

Device Automation Prerequisites

This topic provides a list of components that must be installed and configured on the Automation Devices before you can use Kapow.

Java Access Bridge

To automate applications on remote devices with Kapow, install Java 32-bit on your device (JRE or JDK) and enable the Java Access Bridge in the Java Runtime Environment used by the application. We recommend using the latest available Java version.

For JRE 7 or Later

To enable Java Access Bridge for Java version 7 or later, navigate to the `bin` directory in the Java installation directory and run the following command.

```
jabswitch -enable
```

For JRE6

Follow this procedure to install Java Access Bridge 2.0.2 on a Microsoft Windows 32-bit system. For older applications that require Java version 1.6, copy the following files to the specified destination directories, where `%WINDOWS_HOME%` is the directory where Microsoft Windows is installed (for

example, C:\WINDOWS), and %JAVAHOME% is the directory where your JDK or JRE is installed. The following are examples of directory names for Java SE 6 Update 24.

- JDK: C:\Program Files\Java\jdk1.6.0_24\jre
- JRE: C:\Program Files\Java\jre6

The following table lists Java Access Bridge Windows Libraries and Related Files for Windows 32-Bit

Java Access Bridge File	Destination Directory
WindowsAccessBridge.dll	%WINDOWSHOME%\SYSTEM32
JavaAccessBridge.dll	%JAVAHOME%\bin
JAWTAccessBridge.dll	%JAVAHOME%\bin
accessibility.properties	%JAVAHOME%\lib
access-bridge.jar	%JAVAHOME%\lib\ext
jaccess.jar	%JAVAHOME%\lib\ext

See <http://www.oracle.com/technetwork/java/javase/downloads/jab-2-0-2-download-354311.html> and <http://docs.oracle.com/javase/accessbridge/2.0.2/setup.htm#installing-jab-32-bit> for more information.

Perform the following to test that you have installed Java Access Bridge properly.

1. Run the SwingSet2 application and then run the JavaMonkey.exe application.
2. Select **File > Refresh Tree** in the Java Monkey application and the SwingSet2 application should appear.

Alternatively, you can use the JavaFerret.exe application.

Device Automation on Windows XP

Windows XP prerequisites are listed in the UI Automation article on the Microsoft website.

<https://msdn.microsoft.com/en-us/en-en/library/windows/desktop/ee684009.aspx>

If you get the error: "Module automationnative not found", install the following update.

<https://support.microsoft.com/en-us/kb/2999226>

On some systems Windows Update is not available, but there is a workaround to install updates.

1. Create a c:\temp\976571 folder.
2. Use the following command to extract the contents of the MSU file:

```
Expand -F:* c:\kb976571\Windows6.1-KB976571-v2-x64.msu c:\temp\976571
```

 This command extracts multiple files, from the Windows6.1-KB976571-v2-x64.cab file.
3. Run the following command:

```
DISM.exe /Online /Add-Package /PackagePath:c:\temp\976571\Windows6.1-KB976571-v2-x64.cab
```

See <https://blogs.technet.microsoft.com/askcore/2011/02/15/how-to-use-dism-to-install-a-hotfix-from-within-windows/> for more information.

Configure Device Automation Agent

Once your computers meet all the necessary requirements for device automation, you can install and configure the Automation Device Agent on remote computers.

1. Install Java 32-bit (JRE or JDK) on remote devices and check that Java Access Bridge is enabled on your devices. See [Device Automation Prerequisites](#).
2. Download and install the Kapow Device Automation on your remote computer.
3. Edit the `server.conf` file on your Automation Device. The file is located in your Kapow installation directory under **DeviceAutomationService > conf** directory. See the table with `server.conf` options below.
4. Start the Device Automation service.
Check that the device is registered in the Management Console under **Admin > Devices** tab.

Admin > Devices		
Expand All Collapse All		
Cluster/Device	Status	Labels
Production	Running	
kk80beta2.emea.kofax.com:49998	Available	win2003,sap

The following table lists available options in the `server.conf` file.

Option	Value and Description
"singleUser"	false (default) true Set to false to automatically register the Automation Device Agent with the specified Management Console. For direct connection to the Automation Device, set to true and specify a token.*
"hostName"	Name or IP address of the computer running the Automation Device Agent.
"commandPort"	49998 (default) Reassign this port for the Automation Device if necessary.
"caFile"	empty (default) You can communicate with the Management Console using SSL. If the default certificate in <code>node.js</code> is not used, you can specify a path to another certificate file using this parameter.

Option	Value and Description
"token"	empty (default) If the "singleUser" option is set to <code>false</code> , leave this option empty. If you use the direct connection to the Automation Device (<code>"singleUser": true</code>), specify a token. It can be any token you define.
"drivers"	["automationnative"] (default) This is the default driver for automating native Windows and Java applications. Leave this parameter as is.
"automationnative"	{ "useLegacy": false } (default) { "useLegacy": true } Set <code>useLegacy</code> option to <code>true</code> if you are running Automation Device Agent on a 32 bit Windows system.
Management Console Options	
"hostName"	Name or IP address of the Management Console the device must register with.
"port"	Connection port of the specified Management Console.
"schema"	Connection protocol of the specified Management Console.
"path"	empty (default) The part of the path to the standalone Management Console after the port number. For example, if your Management Console is deployed on Tomcat at <code>http://computer.domain.com:8080/ManagementConsole/</code> , specify <code>"/ManagementConsole/"</code> in this parameter. Leave this parameter empty for the embedded Management Console installation.
"user"	empty (default) User name to authenticate on the specified Management Console.
"password"	empty (default) Password to authenticate on the specified Management Console.
"pingInterval"	5000 (default) Time interval for the Automation Device Agent to ping the Management Console.
"cluster"	Production (default) Cluster name on the specified Management Console.
"labels"	"label1,label2" (default) Labels to distinguish the Automation Devices.

* The direct connection to the Automation Device is recommended only for creating and debugging a robot in Design Studio. When the `singleUser` option is set to `true`, you get the following message when starting the Device Automation Agent.

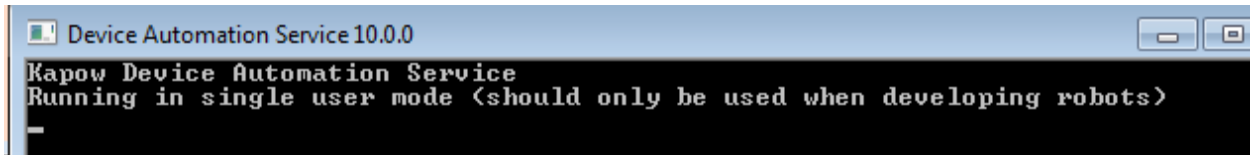

Automation Device Mapping

Preliminary mapping of an automation device makes it possible to access this device from a project in Design Studio. We recommend using the Management Console Based Device Mapping option, because this way you can always be sure that the robots you create will work on the dedicated Management Console with the specified Automation Devices despite changes in the network infrastructure.

The Device Mapping option in the Device Mapping Configuration is recommended for developing and debugging your robot in Design Studio.

Note For automating terminal devices, do not install the Device Automation service on your remote computer or create a device mapping in the Management Console.

Map Automation Device

To map an Automation Device, do the following.

1. Click **New Automation Device Mapping** on the **File** menu or right-click a project in the Projects list and select **New > Automation Device Mapping**.
2. If you started the Automation Device Mapping wizard from the File menu, provide a name and select a project that the device will be associated with. Otherwise, provide a name of the Automation Device. Click Next.
3. In the Automation Device Mapping Configuration step, select either **Management Console Based Device Mapping** or **Device Mapping**.

Management Console Based Device Mapping

This option helps you connect to Automation Devices using mappings in the Management Console. Configure the following.

- **Management Console:** Select the Management Console to use the mappings from.
- **Cluster Name:** Type cluster name on the selected Management Console.
- **Required Labels:** Type one or more labels of the Automation Devices. The labels must be separated by commas.

Device Mapping

This option helps you connect to Automation Devices directly. Configure the following.

- **Host:** Type the Automation Device host name or IP address.
- **Port:** Type the port number to connect to the Automation Device.
- **Token:** Type the token specified in the remote hub settings on the selected Automation Device.

Configure Device Mapping

To edit the Automation Device Mapping, either double-click the device mapping in a project, or right-click the device mapping and select **Configure**. In the **Configure Device Mapping** window, select either **Management Console Based Device Mapping** or **Device Mapping**.

Management Console Based Device Mapping

This option helps you connect to Automation Devices using mappings in the Management Console. Configure the following.

- **Management Console:** Select the Management Console to use the mappings from.
- **Cluster Name:** Type cluster name on the selected Management Console.
- **Required Labels:** Type one or more labels of the Automation Devices. The labels must be separated by commas.

Device Mapping

This option helps you connect to Automation Devices directly. Configure the following.

- **Host:** Type the Automation Device host name or IP address.
- **Port:** Type the port number to connect to the Automation Device.
- **Token:** Type the token specified in the remote hub settings on the selected Automation Device.

Use Terminals with Device Automation

Kapow supports connection to and interaction with 3270, 5250 and stream based (vt2xx) terminals.

Note You do not need to install the Device Automation service on your remote computer or create a device mapping in the Management Console when automating a device with a terminal.

SSH / Telnet Settings

The underlying Kapow SSH client is based on Putty and can potentially be configured to access any system that putty can access. You can configure all the same parameters as you can with a putty session, but instead of requiring the actual putty client to define sessions, you can define session settings by adding parameters to the connection URL.

The headless terminal does not automatically detect the code page on the server. This is why sending and receiving non-ASCII characters requires you to specify the code-page to use for character encoding and decoding. If you do not specify a code page, the robot assumes the server's locale is set to UTF-8. You can specify the code page by using the `LineCodePage` parameter. Kapow terminal is built using "libicu" for character encoding. Use the libicu converter explorer at <http://demo.icu-project.org/icu-bin/convexp?s=ALL> to inspect code pages and their aliases.

The following is a list of the most commonly used parameters.

TermWidth	Sets the terminal width (default is 80).
TermHeight	Sets the terminal height (default is 24).
PublicKeyFile	Specifies the path to a putty formatted *private* key.
TerminalType	Sets the terminal type (default is "xterm").

LineCodePage	Specifies the code-page to use for character encoding and decoding (default is UTF-8).
--------------	--

To set the parameters on your session, append them to the URL, as follows when you enter the value into the Open step.

```
ssh://<username>@<hostname>?TermWith=160&TermHeight=48&LineCodePage=UTF-16
```

SSH Authentication and Security Guide

When automating applications using SSH, the user can be authenticated in four different ways.

1. The underlying ssh client will prompt for a password. The password can be entered using "Enter Text" step followed by a "Press Key" step (return).
2. An unencrypted private key can be placed on the file system of Design Studio and your RoboServers. Add `PublicKeyFile=<path to key>` line to the connection URL. The connection URL could look like the following.

```
ssh://<username>@<hostname>?PublicKeyFile=<path to key file>
```

It is important that the key file is putty formatted. On Linux you can use **puttygen** to transform an open-ssh private key.

3. An encrypted private key can be placed on the file system of Design Studio and your RoboServers. Add `PublicKeyFile=<path to key>` to the connection URL. The underlying ssh client should prompt for a passphrase upon connection. To enter the passphrase, use "Enter Text" step followed by a "Press Key" step (return).
4. Use pageant on Windows and ssh-agent on linux with an encrypted key on the local file system.
 - On Windows, run pageant as the same user running the RoboServer and add the key.
 - On Linux, run `ssh-agent` and `ssh-add` and copy the `SSH_AUTH_SOCK` and `SSH_AGENT_PID` environment variables to the RoboServer and Design Studio environment. You can do it by appending the lines to `RoboServer.conf` and `DesignStudio.conf` as follows.
 - `set.SSH_AUTH_SOCK=<value as outputted from ssh-agent>`
 - `set.SSH_AGENT_PID=<value as outputted from ssh-agent>`

Or by having them already in your environment when starting the RoboServer and Design Studio.

The authentication methods above are listed from the least secure to the most secure as follows.

1. Anyone able to read the robot can extract the password and log onto the system.
2. The attacker would have to have the private key from your file system, so obtaining the robot from a Management Console is not enough.
3. The attacker would need both the robot and the private key file.
4. The attacker would need to obtain the passphrase for the private key to gain access.

Basic Terminal Tutorial

See [Use Terminals with Device Automation](#) for information on terminal prerequisites and settings.

In this tutorial we will connect to a terminal, login, run some commands, and extract information from the terminal.

1. Open an existing project or create a new project (in Smart Re-Execution (Full) mode) and add a new Device Automation step.

2. Add variables that will contain a login name and a password to login to terminal. Also add a variable that will contain the output text. Add the variable with the output to the Return step (=textVariableName)).
3. In the Device Automation editor, add the Open step with the following parameters: Open, OpenStep, local and specify the URI of the terminal. In this tutorial we connect to the 5250 terminal with the following connection string `tn5250://Kapow_5250terminal:11623`.

Where `tn5250` is the terminal type, `Kapow_5250terminal` is the terminal name or IP address, `:11623` is the terminal connection port number.

Note To re-run your device automation step robot for a terminal with an Open step, close the Device Automation Editor, refresh your project in Design Studio, and open the Device Automation step again. If you re-run the robot without closing the terminal, another terminal window opens and the robot may fail to execute.

Click **Single Step** to execute a step.

4. If the terminal needs an Enter key press, right click the terminal in the Device window and select Press Key step. By default it selects Enter as a key.
5. Right click the User id field in the terminal in the Device window and select **Enter Text > From Variable > login** and select the variable that contains the user name. Click **Single Step** to actually type this text into the text field.
6. To shift to the Password field, add the Press Key step and in the Key field, select **Standard Keys > Tab**. Click **Single Step**. The cursor should move to the Password field.
7. Right click the Password field in the terminal window and select **Enter Text > From Variable** and select the variable with the password. To actually type this text into the text field, click **Single Step**.
8. To log in, right-click the terminal in the Device window and select **Press Key** (Enter by default).
9. If the terminal needs an Enter key press, right click the terminal in the Device window and select Press Key. By default it selects Enter as a key.
10. After you execute required commands, you can extract the information from the terminal window. To extract a text line, right-click a row, select **Extract Context into > variableName**. Click **Single Step**. The Variables branch in the State view shows the value you extracted.

If you want to take a screenshot of the entire terminal window (you need to add a binary variable to the Return step (=binaryVariableName)), right-click the screen element in the Device Tree view and select **Extract Image into > binaryVariableName**. Later you can convert the information from the binary variable to an image in your website robot. Click **Single Step**.

Once you extract the information from the terminal, you can return to the website robot editor window and use the extracted information.

Expressions in Device Automation

The set of expressions in Device Automation is an extension of that in Robot Language. See [Expressions](#) for more information. The syntax is implemented in EBNF.

The table below shows the syntax of currently implemented Excel-style expressions. Note that Excel-style expressions must start with the equal (=) sign.

Expression name	Expression syntax
expr	= orExp ifExpr

Expression name	Expression syntax
ifExpr	= orExpr?'ifExpr':ifExpr
orExpr	= andExpr andExpr 'orExpr
andExpr	= relExpr relExpr'&&'andExpr
relExpr	= addExpr addExpr relOp addExpr
relOp	='==' '!=' '<'>' '<=' '>='
addExpr	= mulExpr mulExpr+'addExpr mulExpr-'addExpr
mulExpr	= unExpr unExpr*'addExpr unExpr/'addExpr unaryExpr%'addExpr
unExpr	= factor -'unExpr !'unExpr
factor	='true' 'false' number stringLiteral fieldAccess ('(expr)'
number	= <Integer> <Decimal>
stringLiteral	= <Double quotes ("") enclosing a sequence of any character exceptdoublequotes, control characters or backslash ('\')>
fieldAccess	= identifier identifier.'fieldAccess
identifier	= <A valid Java identifier>

The plus sign (+) operation can be applied to Text, Numbers, Integers, and their combination. It also works if one argument is Text and the other is Boolean, but not on any other types.

Example: Excel-style Expression Examples

- `!=((12-8.1)*3-68==115.0)?true:false`
In this example we match the negation of the expression in brackets to true or false. Note that we can match the result against text or other expression.
- `=3*(12-5.0)/(45%2)`
The percent sign (%) in this expression represents the residue of division.
- `=true&&false||!b1`
This expression translates to the following: true AND false OR NOT b1.

You can use variables instead of numbers in the examples above.

Variables in Device Automation

The Device Automation robot can take input from the legacy robot and can use the same variable types with some additions.

- You can use a complex variable and its attributes as input to Device Automation workflow.
- You can use all complex types from your project to create Record variables in Device Automation robots. Record variables are variables created within the Device Automation workflow.
- You can assign Record variables to each other.
- You can assign attributes of Record variables to values with the same type or to another attributes or simple variables with the same type.

For more information about variables in Kapow, see [Variables and Types](#).

Debug Robots

This section explains how to debug a robot using the debug mode built into Design Studio. To confirm that the robot does what you expect, use debug mode to execute a robot the same way it will be executed by RoboServer.

Basic Debugging

1. To switch to debug mode, click **Debug Mode**  or the Debug button in Design Studio.

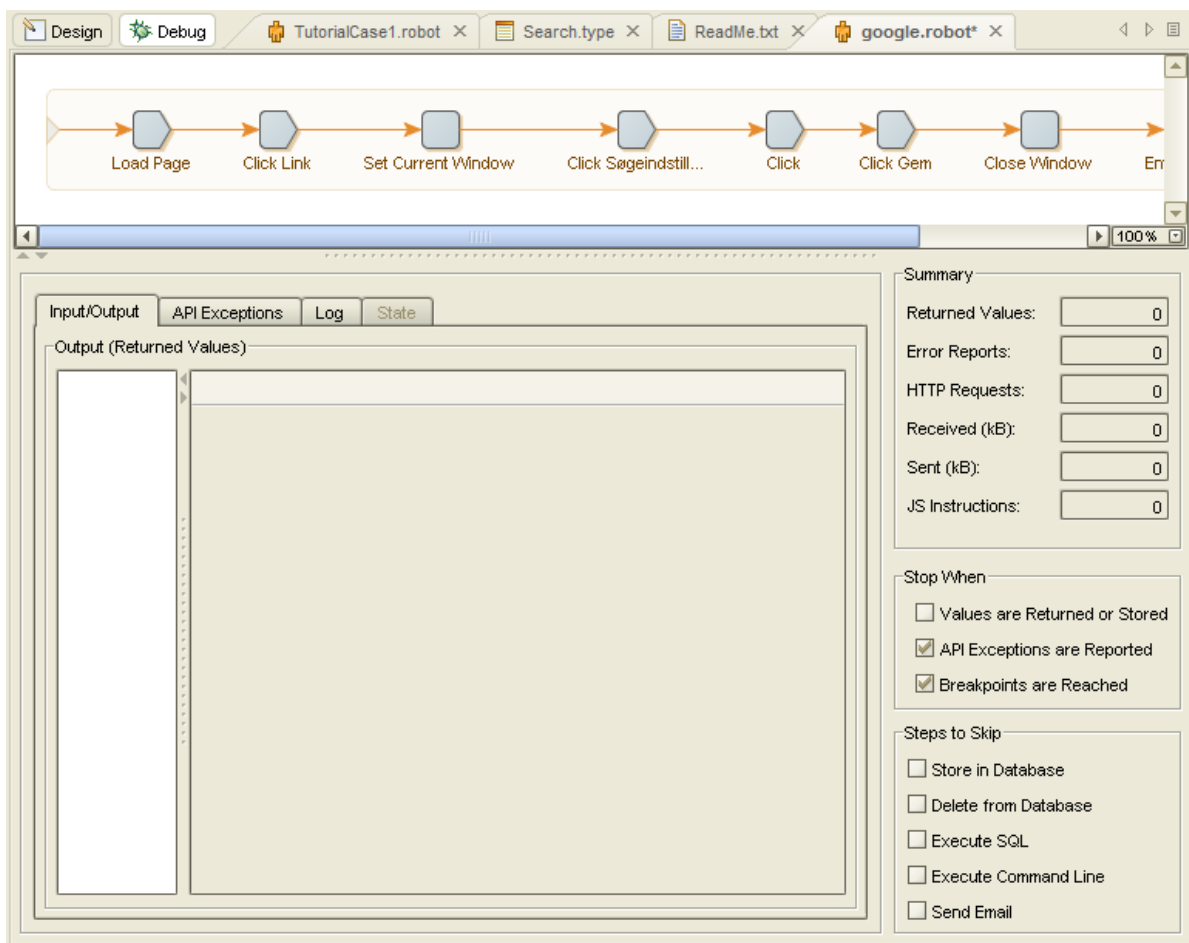

2. To start debugging the robot, click **Play** .
3. In the Robot view you can watch the robot execute in debug mode. You can also watch the results in the main panel. In the Input/Output tab:
 - The Input panel shows the input variables.

Note If the robot has no input variables, the Input panel is not shown.

- The Output panel shows all values returned so far during the execution.
- The API Exceptions tab shows all API exceptions generated during the execution.
- The Log tab shows what has been written to the log during the execution.
- The State tab shows the robot state, if any.
- The Summary panel (to the right of the main panel), shows a summary of the execution. This summary contains the number of returned values, the number of API exceptions generated, statistics on the number of HTTP requests, the amount of sent and received data, and the number of JavaScript instructions executed.

Note It is important to understand that execution in debug mode is independent of the execution done in design mode in Design Studio. Therefore, debug mode has its own current step and its own current robot state, independent of the current step and current robot state in design mode. In debug mode, the current step is the step that is about to be executed, or is being executed in the debugging process, and the current robot state is the input to that step.

4. Click **Stop**  to stop debugging.

You can stop the debugging at any time.

5. To stop debugging when a certain event occurs, enter a **Stop When** action.

Here, you can select whether the debugging should stop when values are returned, when API exceptions are reported, and when breakpoints are reached.

Of course, debugging always stops when the execution of the robot has completed.

When debugging has stopped, you can see the reason for the stop in the status bar at the bottom of the Robot Editor.

If the debugging has stopped before the execution of the robot is complete, you can watch the current robot state in the State tab. The Variables, Windows, Cookies, and Authentications sub-tabs show the robot state in the same way as in the State View in Design Studio. The API Exception sub-tab shows the API exception, if the execution stopped because an API exception was reported.

6. If debugging has stopped before the execution of the robot is complete, click **Play**  to resume debugging.

You can also click **Restart**  to restart debugging. This cancels the current debugging process and makes the debugger ready to start a new debug operation from the start of the robot.

Note The debugging is also restarted automatically whenever the current robot is modified or replaced by another robot in Design Studio.

7. If the robot has input variables, you can edit the variables in the Input panel. Press Enter to restart debugging with the new input values.

You cannot edit the input values while a debug is running. To change the input values, you must first restart the debugging.

Debug from the Current Location in Design Mode

1. To start debugging from the current location, in Design Studio, Design Mode, click **Return From Location** .

The Robot Editor switches to debug mode and executes, as directly as possible, to the location that is current in design mode.

When that location is reached, debugging is stopped.
2. Click **Play**  to continue debugging from this location.

This feature is useful to debug a part of the robot, such as a specific branch or a specific iteration of a loop action.

If Design Studio is already debugging the robot when you click **Return From Location** , it must restart the debugging before it executes to the location, and prompts you for permission.
3. Click **OK**.

Return to Design Mode from a Debugging Location

During debugging, you can return to a location using Go To Design, or GOTO. The following steps demonstrate returning to Design Mode for both options.

1. When debugging has stopped at some location in the robot, in debug mode, click **Go To Design Location**  to switch back to design mode at the same location.

This allows you to closely examine that location in design mode, and perhaps modify the steps around that location, or modify some other part of the robot.

Alternatively, you can switch to design mode and go to the location where a value was returned.
2. On the Input/Output tab, select the value in the Output panel and click **Goto** in the lower right corner.

This is useful if a value has not been extracted correctly, and you want to find out why.

You can also switch to design mode and go to the location where an API exception was reported, or where an error occurred.
3. When you view an API exception in the API Exceptions tab or the API Exception sub-tab in the State tab, click **Goto** next to the location code to go to the location where the API exception was generated. Click **Goto** to the right of a specific error, to go to the location where that error occurred.

This is useful when you want to find the reason for the error and fix the problem.
4. When finished with design mode, you can resume the debugging. If you haven't modified the robot, you can click Play .

If you have modified the robot, the debugging is automatically restarted, so you cannot resume it directly. Instead, you can click **Debug From Location**  to start a new debugging session from the current location in design mode.



Use Breakpoints

While debugging, you can set a breakpoint to make Design Studio stop at a specific step.

1. In the Robot View, right-click a step and select **Toggle Breakpoint**.

The breakpoint is indicated by the Breakpoint  icon in the step.



During debugging, Design Studio stops at the breakpoint.

2. To stop debugging when a certain action takes place, enter **Stop When** parameters.
3. Click **Play**  to resume debugging.
4. To remove a breakpoint, right-click the step and select **Toggle Breakpoints**.
5. To remove all breakpoints from multiple steps, select one or more steps and click **Remove Breakpoints**.
All breakpoints are removed from the selected steps.
6. To remove all breakpoints in a robot, click **Remove All Breakpoints** .
All breakpoints are removed from the robot.



Single Stepping

You can use single stepping to execute one step at a time in debug mode. Single Stepping is useful if you want to examine the execution very closely.

Note You can single-step when Design Studio is ready to start a new debug, or when it has stopped during a debug.

1. To execute the next step, click **Single Step** .
When that step has been executed, execution is stopped.
2. Click **Single Step**  again to execute the next step, and so on.
3. To resume normal execution, click **Play**  at any step.

Step Into

1. If you used the [Group step](#) to create a group containing several steps, create a breakpoint at the group step in the same way a step was created at any other step.
 - If the group is collapsed using [Single Stepping](#), Design Studio treats the group as a single step and will not enter any of the grouped steps.
 - If the group is expanded, the steps in the group are visited when using single stepping.
 - If a group is collapsed, using the Step Into  icon, instead of the Single Step  icon, it results in the debugger stepping into the group and visiting each step.
2. To leave the group and advance the debugger to the step following the Group step, click **Step Out** .

Design Studio Settings

Use the following tabs on the Design Studio Settings window to set preferences for Design Studio:

- [General Settings](#)

- [Text Files](#)
- [Robot Editor](#)
- [Local Databases](#)
- [Proxy Servers](#)
- [Certificates](#)
- [Bug Reporting](#)
- [Management Consoles](#)

General

When you open the Design Studio Settings window, the General tab appears by default. Use this tab to set general preferences for Design Studio.

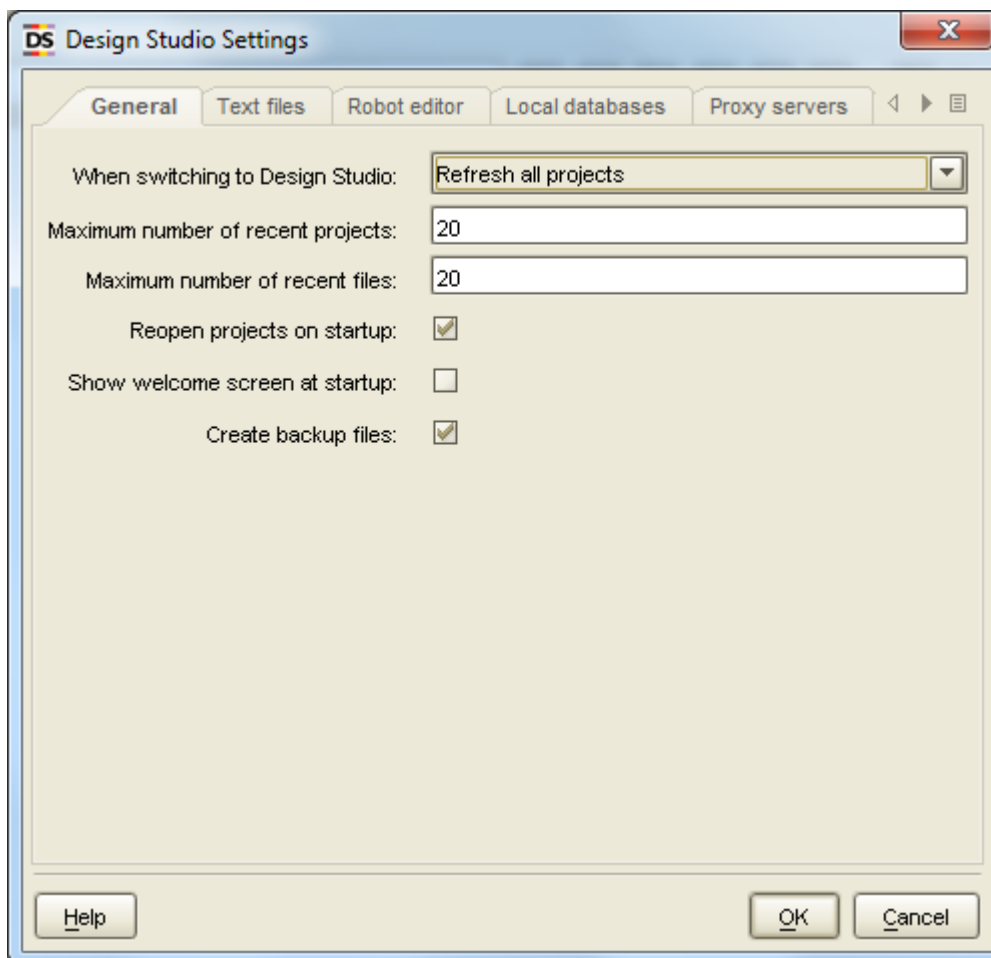

The following table describes the options on the General tab.

Option	Description
When switching to Design Studio	Indicates what happens when the user switches to Design Studio.
Maximum number of recent projects	Lists the maximum number to include in the local history of recent Design Studio projects. Users can access the list by selecting File > Recent projects .
Maximum number of recent files	Lists the maximum number to include in the local history of recent Design Studio files. Users can access the list by selecting File > Recent files .
Reopen projects on startup	When selected, the most recent project is reopened when Design Studio is started.
Show welcome screen at startup	When selected, the Welcome screen is shown when Design Studio is started.
Create backup files	When selected, backup files are created whenever a saved file is changed. Backup file names end with a tilde (~) character.

Text Files

Use the "Text files" tab to set preferences for text files used in Design Studio.

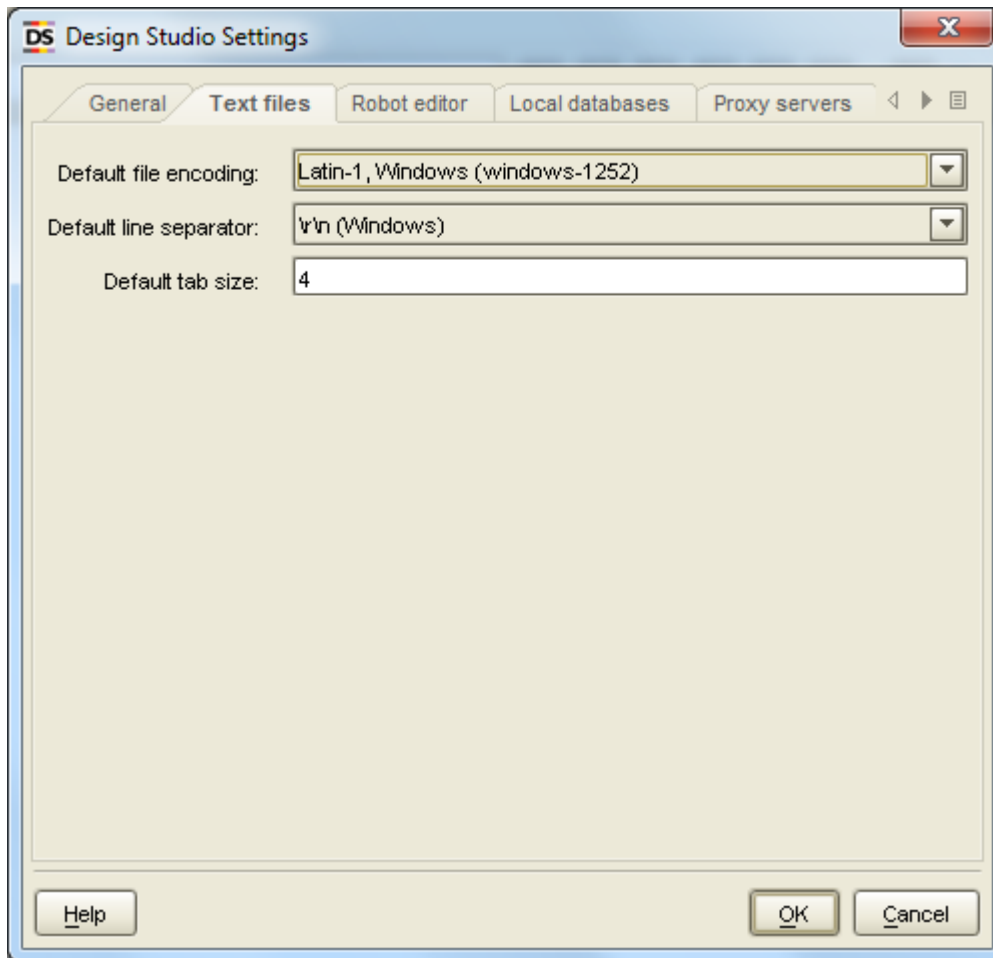

The following table describes the options on the "Text files" tab.

Option	Description
Default file encoding	Specifies the default encoding of text files.
Default line separator	Specifies the default line separator in text files.
Default tab size	Specifies the default tab stop in text files.

Robot Editor

Use this tab to set preferences for the Robot editor.

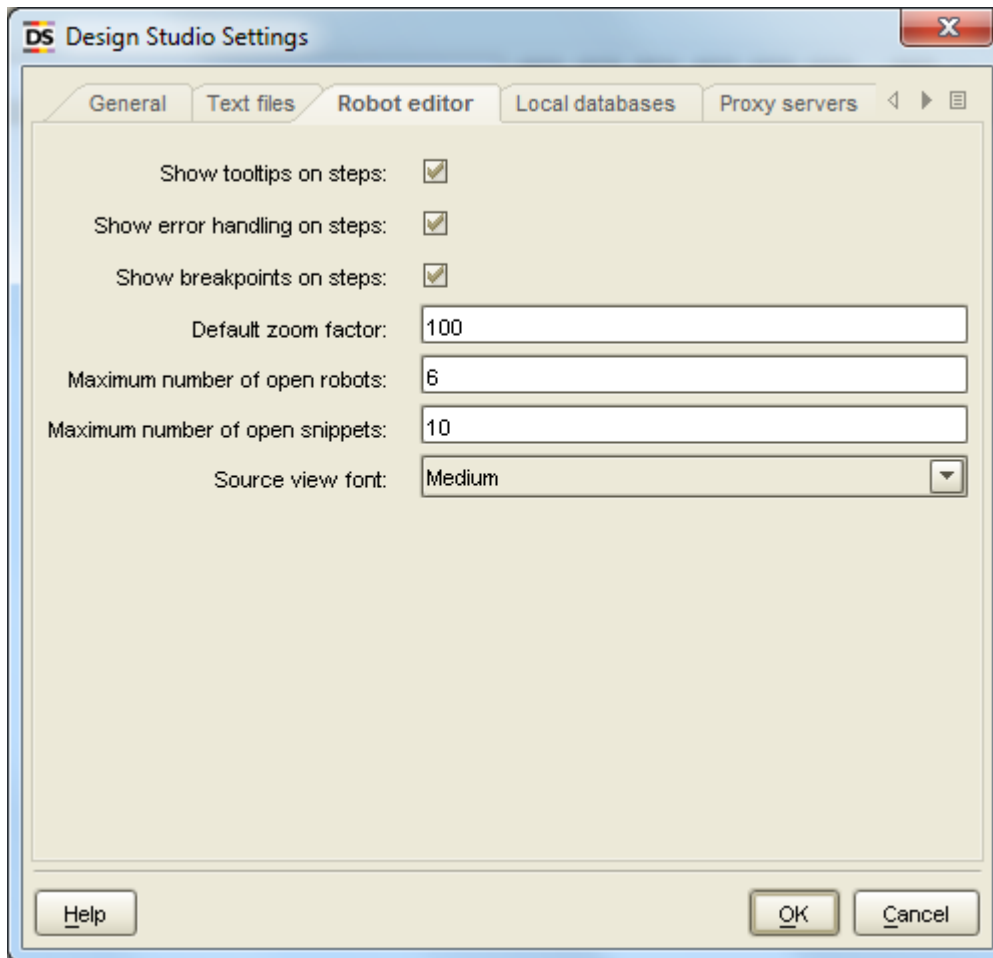

The following table describes the options on the "Robot editor" tab.

Option	Description
Show tooltips on steps	When this checkbox is selected, tooltips are shown for robot steps.
Show error handling on steps	When selected, robot steps with custom error handling are marked with a symbol.
Show breakpoints on steps	When selected, robot steps with a breakpoint are marked with a symbol. When the debugger is run, execution is stopped at the step that is marked.
Default zoom factor	Lists the zoom factor to apply when robots are opened in the robot editor. You can manually adjust the zoom factor from the lower right corner of the robot editor.
Maximum number of open robots	Lists the maximum number of robots to open in the robot editor. Upon attempts to exceed the maximum, the user is prompted to close a robot.
Maximum number of open snippets	The maximum number of open snippets in the editor. If the maximum number of snippets have been opened, the user is asked to select which snippet(s) to close when attempting to open more snippets.

Option	Description
Source view font	Specifies the point size of the text font in the source view (the bottom section of Design Studio).

Local Databases

Use the "Local databases" tab to create a database in Design Studio. Note that databases created in Design Studio are only available in Design Studio.

To make the database available both in Design Studio and on the server, the databases must be configured in the [Management Console](#).

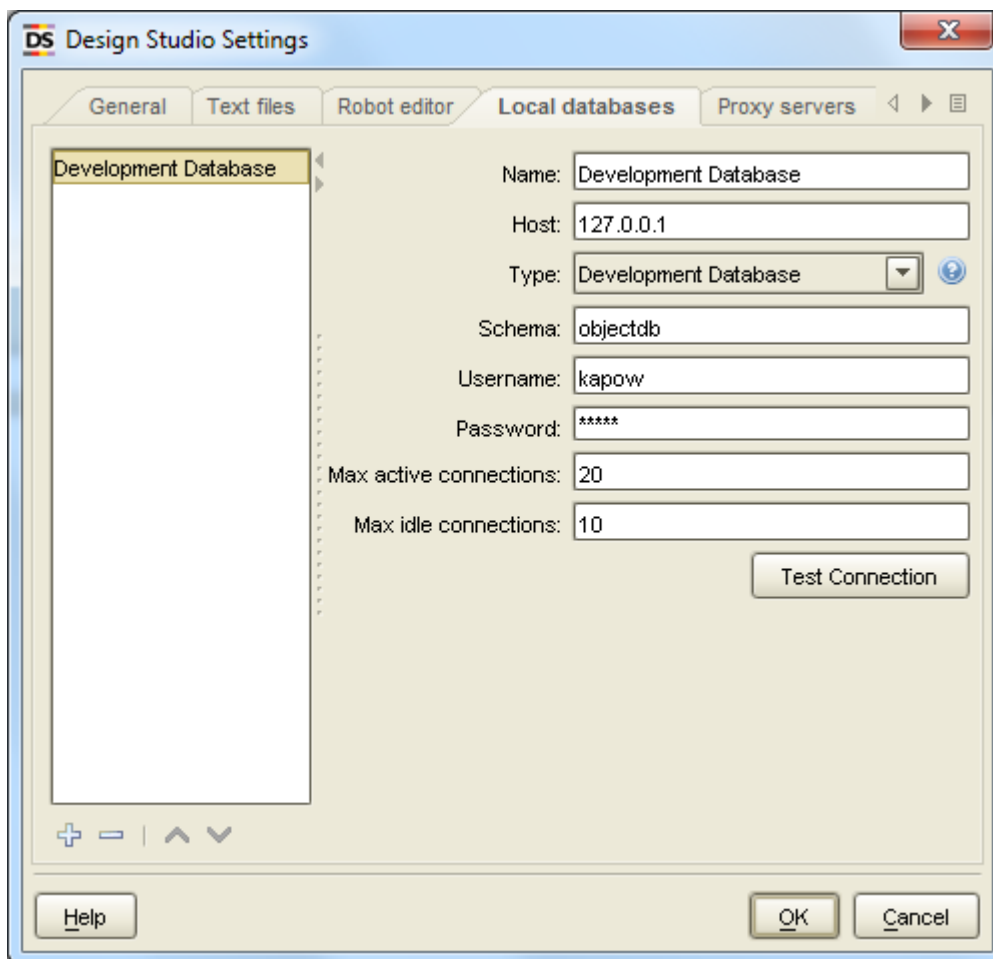

A list of connections created are shown on the left. You can create new connections, remove connections, or change their order using the buttons below the list. The currently selected connection is configured in the right side of the window. The field name, host, type and schema are mandatory and must be specified.

The different database types are defined in the Management Console and automatically distributed to Design Studio at startup. New database types must be created in the Management Console.

Option	Required	Description
Name	Yes	A name for uniquely identifying the database in Kapow. The name is used for internally referencing the database and it may only contain alphanumeric characters and underscores.
Host	Yes	The host name of the database server. This can be an IP address, or the fully qualified domain name, such as myhost.kapowtech.com.
Type	Yes	The type of database, such as Oracle. The different types of databases are configured in Management Console and provided automatically at Design Studio startup.
Schema	Yes	The name of the database schema (or catalog).
User Name	No	The user name for the database.
Password	No	The password for the database.
Max Active Connection	Yes	The maximum number of concurrent connections to the database that Kapow (RoboServer or Design Studio) create. The connections are managed by a connection pool, which means that existing connection is reused before creating new connections.
Max Idle Connection	Yes	The maximum number of idle connections allowed. If more connections are created due to a heavy load, they are closed automatically when no longer needed.

To test the current connection, click **Test Connection**.

Note This will only test the connection to the database; it will not test that you have the proper permissions in the database.

Connecting to Oracle: If you are using an Oracle database, In the Username field, you must enter a username and a role. For example, if the username is "sys" and the role is "sysdba," you should enter "sys as sysdba" in the Username field.

Proxy Servers

Use the Proxy Servers tab to specify the number of proxy servers that can be used by Design Studio.

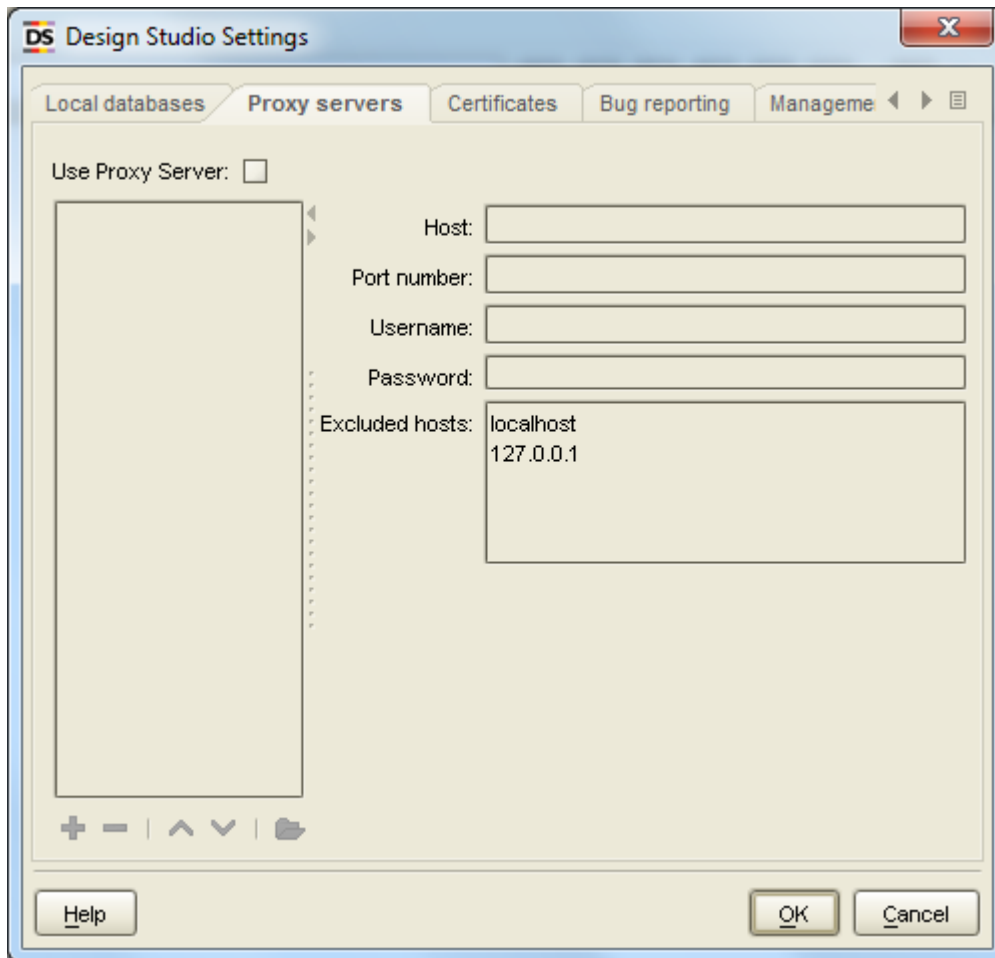

The following table describes the options on the "Proxy servers" tab.

Option	Description
Use Proxy Server	When selected, the use of a Proxy Server is enabled.
Host	The host name of the proxy server, which can be an IP address, or the fully qualified domain name, such as myproxy.kapowtech.com.
Port Number	The port number on the proxy server. Leave this blank to use the default proxy server port 8080.
User Name	The user name to use if the proxy server requires a login.
Password	The password to use if the proxy server requires a login.
Excluded Hosts	Here, you can specify a list of host names that the proxy server should not be used for. Specify one host name per line. Each host name can be an IP address or a fully qualified domain name, such as www.kapowtech.com.

Use the Import button under the proxy server list to import a list of proxy servers. The file may hold an arbitrary number of proxy server definitions, each of which must comply with the following format:

```
proxyName.proxyServerUse = true
    proxyName.proxyServerHost = host name or IP address
    proxyName.proxyServerPort = port number
    proxyName.proxyServerUserName = user name
    proxyName.proxyServerPassword = password
    proxyName.proxyServerExcludedHostNames = list of hosts
```

Where proxyName is a name to identify a particular proxy server. Each proxy server must have its own unique proxyName.

When multiple proxy servers are specified, a new proxy server is selected every time a robot is run.

You can also specify a proxy server for an individual robot. This is done when you configure the robot in the Robot Configuration window in Design Studio. Such a proxy server overrides the proxy servers specified here. See [Configuring Robots](#) for more information. Furthermore, the proxy server is changed during robot execution with the [Change Proxy](#) action.

See [Using Proxy Services](#) for more details.

Certificates

Use the Certificates tab to specify whether a robot should verify the identity of a web server that it accesses via HTTPS. Such a verification is routinely (and invisibly) done by ordinary browsers to detect phishing attacks. However, the verification is often not necessary when robots collect information, because the robots only access the web sites that they have specifically been written for. Thus the verification it is not enabled by default.

Verification is done in the same way a browser performs verification.

The web server's certificate is checked based on an installed set of trusted HTTPS certificates similar to those you can configure in a browser. See the *Kapow Developer's Guide* for more information about HTTP certificates.

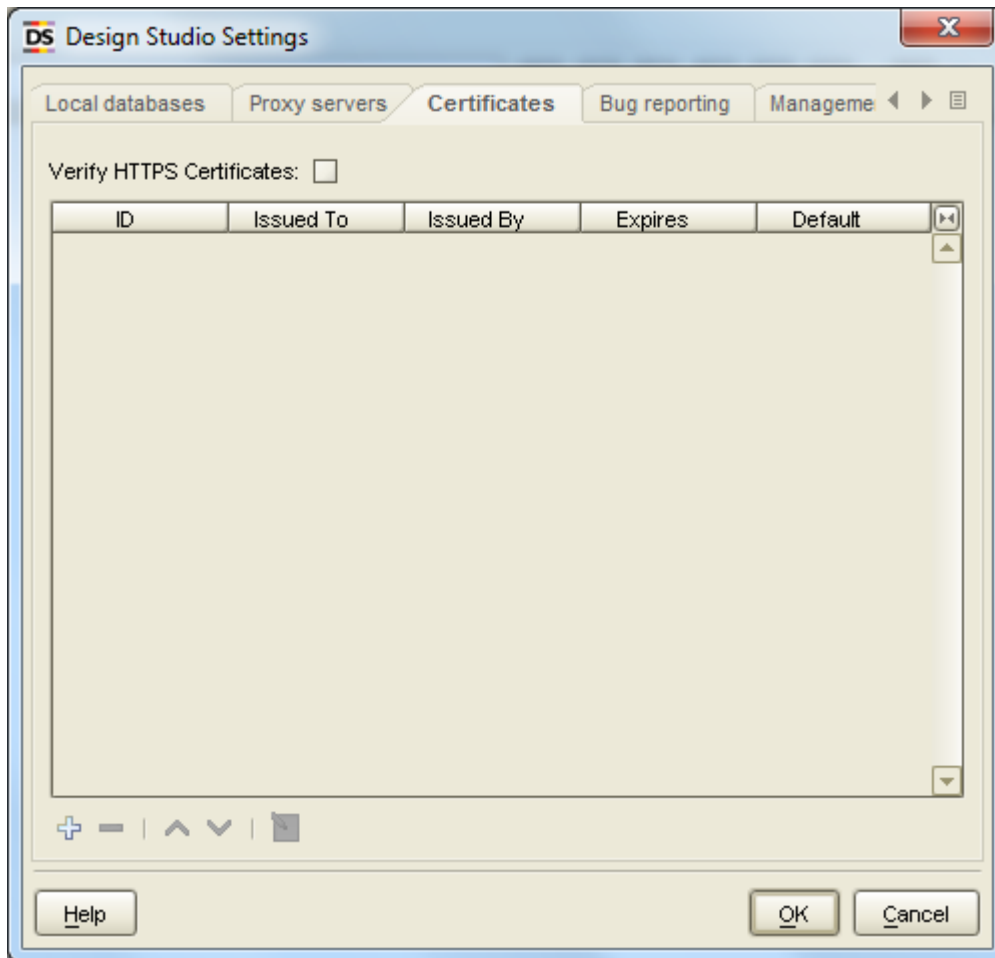

The following table describes the options on the Certificates tab.

Option	Description
Verify HTTPS Certificates	When selected, a robot verifies a web site's certificate when accessing it over HTTPS. Verification is done based two sets of trusted certificates: the set of root certificates and an additional set of server certificates.
HTTPS Client Certificates	A list of client certificates that the robots can use. Use the buttons under the list to add or remove certificates.

Note that root certificates are installed with Design Studio just as root certificates are installed with your browser. They are found in the Certificates/Root folder in the application data folder. See the *Kofax Kapow Installation Guide* for more information.

Some HTTPS sites may use certificate authorities that are not included by default. In this case, you need to install the appropriate certificates for Design Studio to load from these sites. Most often, these would be installed in the Certificates/Server folder in the application data folder.

For the purpose of handling HTTPS sites, it does not matter whether you add certificates to the set of root certificates or the set of server certificates.

To install a certificate, you need to obtain the certificate as a PKCS#7 certificate chain, a Netscape certificate chain, or a DER-encoded certificate. You install the certificate by copying it to one of the folders mentioned above. The name of the file containing the certificate does not matter.

Bug Reporting

Use the Bug Reporting tab to set preferences for emailing bug reports related to internal Design Studio errors. When an internal error occurs in Design Studio, the user can send a bug report with details about the error. The user can also send a bug report manually, by selecting the Report Bug action from the Help menu.

Users are generally encouraged not to change the default settings on this tab unless absolutely necessary.

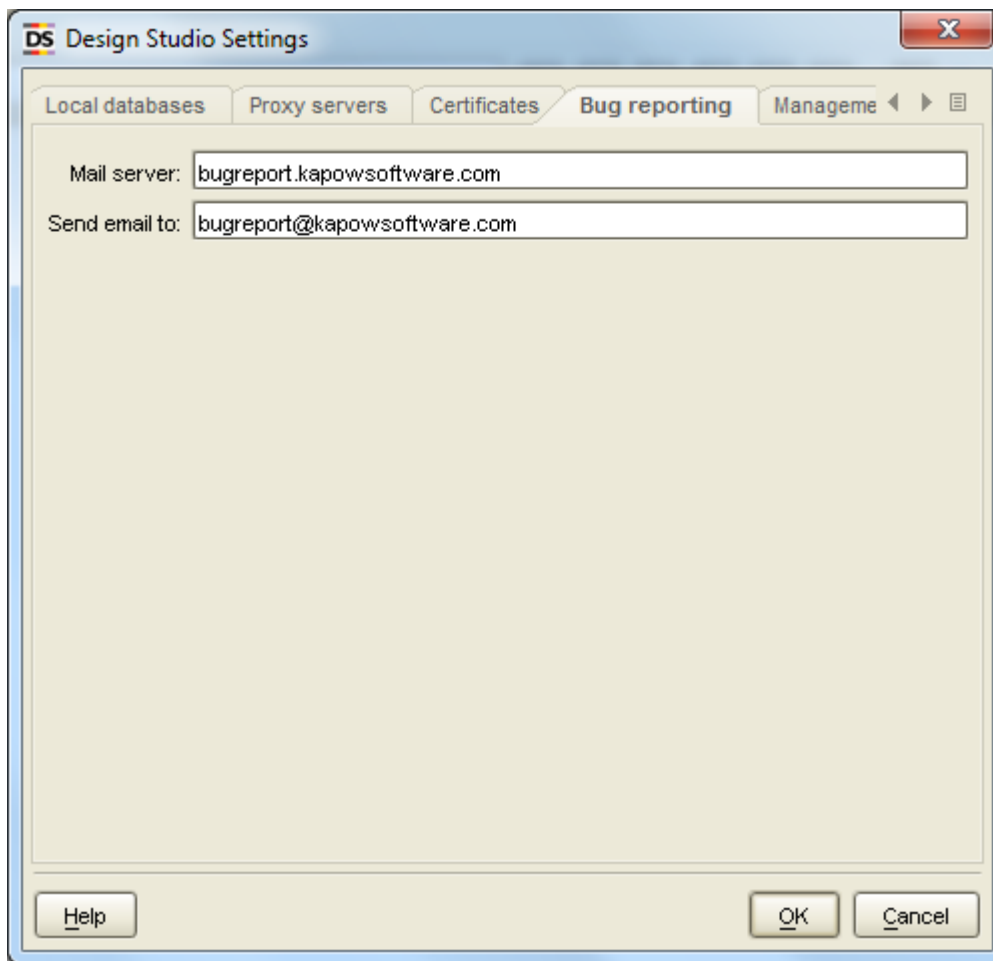

Option	Description
Mail server	Lists the mail server to use when sending bug reports.
Send email to	Lists the email address to which bug reports should be sent.

Management Consoles

Use the Management Consoles tab to configure connection settings to Management Consoles. The URL must be unique, but you can configure several connections to the same Management Console with different protocols, user names and passwords. The first time you start Design Studio and specify a license server, that server is automatically added to the list of Management Consoles.

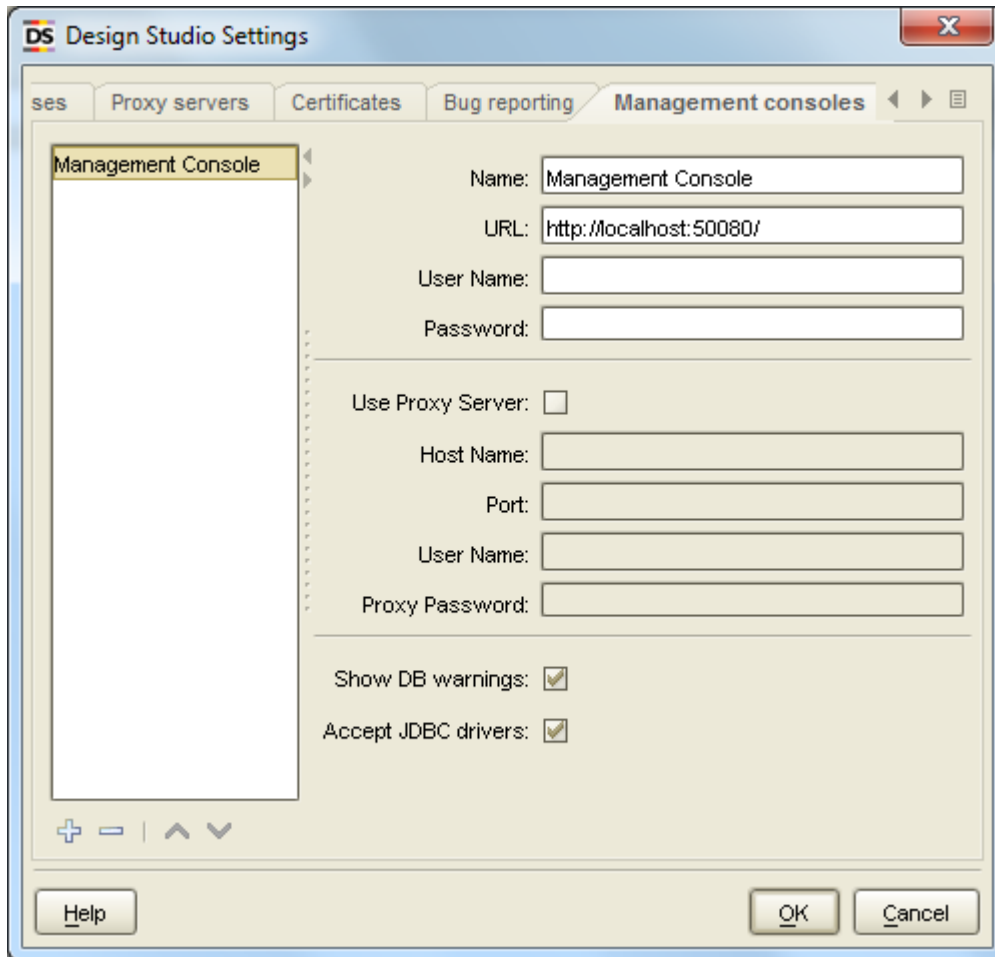

Name

Name of the Management Console.

URL

A URL to connect to the Management Console. Specify the protocol by typing either `HTTP` or `HTTPS` and a port number. For example, `http://localhost:50080/`. You can also use an IP address in this field.

User Name

The user name required to access the Management Console, if any.

Password

The user's password, if any.

Show DB warnings

When selected, database warnings, such as missing tables, are shown at the top of the robot editor.

Accept JDBC drivers

When selected, JDBC drivers are distributed from Management Console to Design Studio. Users should rarely need to disable this option.

Chapter 5

Management Console

The Management Console is a web-based interface providing point and click monitoring and management of the Kapow platform servers.

In the Management Console, you can:

- Enable collaboration and sharing using the repository.
- Manage user roles and permissions, and centrally administer the solution.
- Schedule robots from the repository.
- Browse extracted data and export to MS Excel.
- Access detailed logs of production results and errors.
- Monitor RoboServer health and resource usage in a graphical dashboard.
- Configure clusters of multiple RoboServers.
- Deploy robots from Design Studio to the repository.
- Run Kapplets.

Before proceeding, you may want to take the [Management Console Beginner's Tutorial](#).

Introduction to Management Console Structure

The Management Console is divided into five functional areas.

Dashboard

The Dashboard gives you a quick overview of the Management Console. The information is presented through portlets, which show the health of your RoboServers, schedules, and robots.

Kapplets

A Kapplet is a web-based user interface used to run a robot without any programming.

Schedules

A schedule is a plan for running one or more robots, typically at pre-planned points in time and in a repeating fashion. A schedule does not run robots itself; it merely provides the plan for when the robots should be run (which is done by passing them to the configured servers).

Repository

Robots, type definitions and resources can be uploaded from Design Studio to the Management Console repository or uploaded manually through the web interface of the Management Console. Uploaded robots can be executed as part of a Schedule or through client code that executes robots using the Kapow Java or C# APIs. You can also use the APIs to programmatically query or update the repository.

Data

The Data View allows you to see the data your robots have stored in databases or to export this data to Excel or XML.

Logs

Use logs to view the execution history of your schedules. If database logging is enabled, you can also view the RoboServer logs which contain details of every robot execution.

Admin

Use the Admin section to configure settings for the Management Console. It also enables you to manage the clusters of RoboServers and their settings, as well as manage projects and permissions. This is also where you configure the license and create/restore backups.

Note Some features such as High Availability may not be available, depending on your license key.

Naming Policy

Note the limitations when using "." in file names:

- It is not possible to upload files and create folders starting with ".".
- It is not possible to create a database (under cluster) and a database mapping (under project) using a name starting with ".".

Start the Management Console

The Management Console component is an optional part of a RoboServer. You start the Management Console by starting a RoboServer and instructing it to function as a Management Console, it may still also run the RoboServer functionality. For information on starting and using a RoboServer, see the *Kapow Administrator's Guide*.

A RoboServer with Management Console functionality may be started with the Start Management Console item in the Start menu (on Windows). On Linux and Unix variants, you can use the command line:

```
RoboServer -MC
```

This starts a RoboServer as Management Console only, and thus is not capable of running any robots. The Management Console's web interface is accessible by connecting to the port configured in Settings. See the "RoboServer Configuration" in the *Kapow Administrator's Guide* for more information on Configuring the Embedded Management Console. If you start the Management Console this way, it cannot be restarted or shut down via Control Center or the ShutDownRoboServer program.

You can also use the following command to start the Management Console:

```
RoboServer -p 50000 -MC
```

This starts a RoboServer listening on a socket at port 50000, and providing Management Console functionality via a web interface on a configured port (the port is configured in Settings).

Regardless of how the Management Console is started, a license key must be entered into the web interface before it can function as a license server for RoboServer and Design Studio instances.

For production scenarios, we recommend that you start one RoboServer with the Management Console but not add that RoboServer to a cluster. That way, you prevent Management Console starvation that may occur if it is denied access to resources that are in use by the RoboServer. After setting up the RoboServer running the Management Console, you can start as many RoboServers as you like using the parameter `-p 50000`. These are the only RoboServers that should be added to the RoboServer Clusters on the [Clusters tab](#).

Management Console Configuration and User Interface

The Management Console has a web-based user interface, which makes it easy to access from any machine on the same network. If it is installed on the machine named *hostname*, you simply need to point your browser to:

```
http://hostname:50080
```

The port number 50080 is configurable as described in "Configuring the Embedded Management Console" in the *Kapow Administrator's Guide*.

Use the tabs at the top of the window to navigate within the Management Console.

Most subsections of the Management Console display items of a certain type in a table. When there are many items to display, they are divided into pages. The **Schedules per page** setting can be used to select how many items (schedules in this case) to display at the same time. Please note that this number does not adapt automatically to the height of the browser window. Thus empty space below the table does not always mean that you are seeing the last items - it may also mean that the "per page" setting is too low compared to the window height.

At the bottom of the table you can navigate between the individual pages of display, thus moving upwards and downwards within the same table. The  button refreshes the display.

The tables support sorting. Click any column heading to sort by that column. Click the same column heading again to reverse the sorting order. Sorting is performed on the whole table, not on each page individually. Thus if you have more than one "page," you may see a completely different set of rows if you change the sorting order.

Starting from Kapow version 10, all RoboServers must auto register to the Management Console. Therefore, the URL and credentials for the Management Console along with the cluster name must be specified when starting the RoboServer (either at the command line or using the [RoboServer Settings](#) application).

Dashboard

The Dashboard contains portlets which display the status of various areas of your system. When you first access the dashboard it will contain four portlets; add additional portlets to the dashboard by selecting them from the list, and pressing the **Add** button.

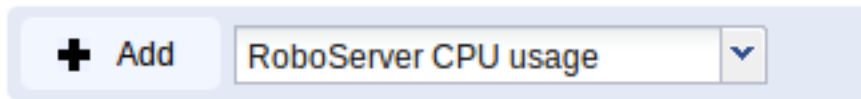

If you have a large screen, you may benefit from selecting to display the portlets in 3 columns rather than 2. Each portlet contains a toolbar with four buttons.



The first button minimizes the portlet, the second refreshes the portlets data, the third displays info about the portlet, the fourth closes the portlet (it may be added again). Whenever you add, remove, or rearrange any of the portlets on the dashboard, the layout is stored in a cookie inside your browser so that the next time you visit the dashboard, your previous layout is restored.

To get more information, point to the datapoint on a graph. You can see the time and value of the datapoint as well as the name of the series, such as the RoboServer name.

The dashboard contains the following portlets:

Most Errors, by Robot - last 100 runs

The graph shows the 100 latest runs for the 10 robots with the most errors (relative to extracted values). You can click a point on the graph, and the Management Console will switch to the log view, and display the information for this particular run. Notice that the Y-axis is logarithmic. For this graph to work you must enable [database logging](#) on at least one cluster.

Summary, last 24 hours

Displays a summary for each project in the Management Console. Use this view to see the 20 most recent executions of each schedule. The health bar gives a quick overview of the status of each project and schedule. Each color on the health bar denotes the status of the schedule execution:

Red

Indicates that at least one schedule error occurred. A schedule error is any non-robot error that occurred during the execution of the robot.

Orange

Indicates that at least one of the robots that executed in this schedule gave an error (and that there were no schedule errors).

Yellow

Indicates that the schedule was ignored because it was already executing.

Green

Schedule executed successfully; no schedule errors or robot errors.

The size of each color on the health bar is relative to the number or schedule runs with the given status.

RoboServer memory usage

Displays the memory usage over time (last 55 hours) for each RoboServer listed on the [Clusters Tab](#)

RoboServer CPU usage

Displays the CPU usage of the RoboServer process. If you have multiple RoboServers, there will be a graph for each one.

RoboServer KCU usage

Displays the KCU usage of each of the RoboServers.

RoboServer Wait Time

The time a RoboServer has waited for KCU to become available. If there is any wait time, the performance of your robots can be increased by acquiring a license with more KCUs.

Total bytes loaded

Displays the total bytes loaded (last 55 hours) for each RoboServer listed on the Clusters tab. The graph resets at midnight.

Total executed robots

Displays the number of executed robots (last 55 hours) on each RoboServer listed on the Clusters tab. The graph resets at midnight.

Concurrent robots

Displays the number of concurrent robots for each RoboServer listed on the Clusters tab. The graph resets at midnight.

Total HTTP requests

Displays the total number of HTTP requests loaded by each RoboServer listed on the Clusters tab. The graph resets at midnight.

Records in Log Database

Displays the number of records for "Robot run," "Robot message," "Schedule run," and "Schedule message" in the log database (make sure to configure the log database in **Admin > Settings** tab. See [Logs](#) for more details).

Records in Analytics Database

Displays the number of records for all RoboServers.

Note The availability of the Analytics functionality depends on the license.

Kapplets

In the Management Console, Kapplets are separate entities you can manage on the Kapplets tab.

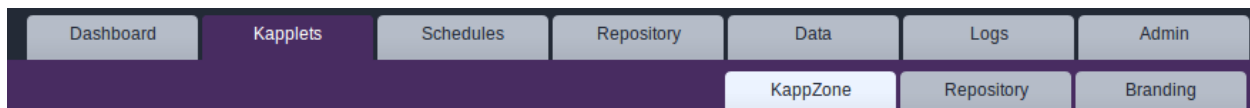

Select this tab to view the subsections.

KappZone

View all Kapplets you are currently allowed to use. From here you can install Kapplets to be available in My KappZone. See [Invoking Kapplets](#).

Repository

View a list of currently defined Kapplets . Here you can view, delete, and edit Kapplet definitions. To create new Kapplets, open the Kapplets User area. See [Creating Kapplets](#).

Branding

Kapplet Administrators use the Branding tab to customize the basic appearance of Kapplets. See [Customizing Kapplet Branding](#).

Note Not all Management Console users can use or administer Kapplets. Rights are assigned in the project Permissions tab. Note that security options are not as strict for the Standard edition, which gives all users permission to view and edit Kapplets.

See [Kapow Kapplets](#) for information about building and using Kapplets.

Schedules

The Schedules subsection enables you to manage the schedules on this Management Console. A schedule denotes a selection of robots and plans for running them. Running the schedule means running the selected robots (in parallel or sequence) optionally executing pre- and post-run scripts or robots.

The following information is displayed for each schedule in the list of schedules. The information is presented in columns. Some of the columns are hidden by default, and can be shown by clicking the down arrow on the column header, and selecting the columns.

Column	Description
Active	When Active, the schedule runs as planned. You may want to make a schedule inactive for several reasons, such as: <ul style="list-style-type: none"> Because the function performed by the schedule currently is not needed. Because errors have been found in the robots and you don't want the schedule to run before you have fixed these errors. Because you want to trigger the schedule manually each time it should run. This may be appropriate for some robots and schedules, for example for preparation or clean-up tasks.
Name	The name of the schedule.
Project Name	The name of the project that the schedule belongs to (useful when the 'All' project is selected).
Robot count	A combination of total and active robots. If all robots are active it will simply list the number of active robots; if 2 of 3 robots are active it will list 2 (3).
Total robots (hidden by default)	The total number of robots in the schedule. (To see the robots, edit the schedule as described below.)
Active robots (hidden by default)	The number of active robots in the schedule. (To see the robots, edit the schedule as described below.)
Next Run	The time when the schedule is planned to run next.
Previous Run	The time when the schedule was last run.

Column	Description
Interval	The planned interval between two consecutive runs of the schedule.
Total Runs	How many times the schedule has been run.
Created By (hidden by default)	The name of the user that created this schedule.
Modified By (hidden by default)	The name of the user that last modified this schedule.
Object DB (hidden by default)	(The Object DB is a legacy feature, and used with collection robots prior to version 7.2.) The name of the database to store values extracted by this schedule's robots. When not empty, a Database Storage Environment is passed along with the robots to RoboServer.
RoboManager DB (hidden by default)	(The RoboManager DB is a legacy feature, and used with collection robots prior to version 7.2.) The name of the database to store log information data about robots run via this schedule. When not empty, a Database Robot Info Environment and a Database Message Environment is passed along with the robots to RoboServer.
Cluster (hidden by default)	The cluster that the schedule executes on.
Delete	Click this button to delete the schedule.
Edit	Click to edit the schedule or to view more details on a specific schedule. You can also edit a schedule by double-clicking the row.
Run/Stop	Click to manually run the schedule. This is especially useful for inactive schedules. If the schedule is already running, it will be stopped. That is, all its running robots are stopped as quickly as possible. The schedule is displayed as "running" until all its robots stop executing.
Errors	The number of schedule errors during the last run of the schedule. Schedule errors do not include robot errors. Schedule errors prevent the schedule from running, such as a deleted cluster or errors in pre- or post-processing. Note To see Errors (and Robot Errors), make sure the log database is set up in the Management Console settings (see Settings->Log Database) and that database logging is enabled on the RoboServers via the logging cluster settings . For more information, see Logs .
Robot Errors	The number of robot errors that occurred in robots run by this schedule.

To create a new schedule, click **Add** above the list of schedules. If the current project selection is All, when clicking the **Add** button, you have to select an actual project before you can add a new schedule.

To copy an existing schedule, right click a schedule and select **Create Copy**.

Clicking  in the "Edit" column or double-clicking anywhere in the row for an existing schedule brings up the "Edit Schedule" dialog box, which is useful for changing the schedule or viewing all details about it.

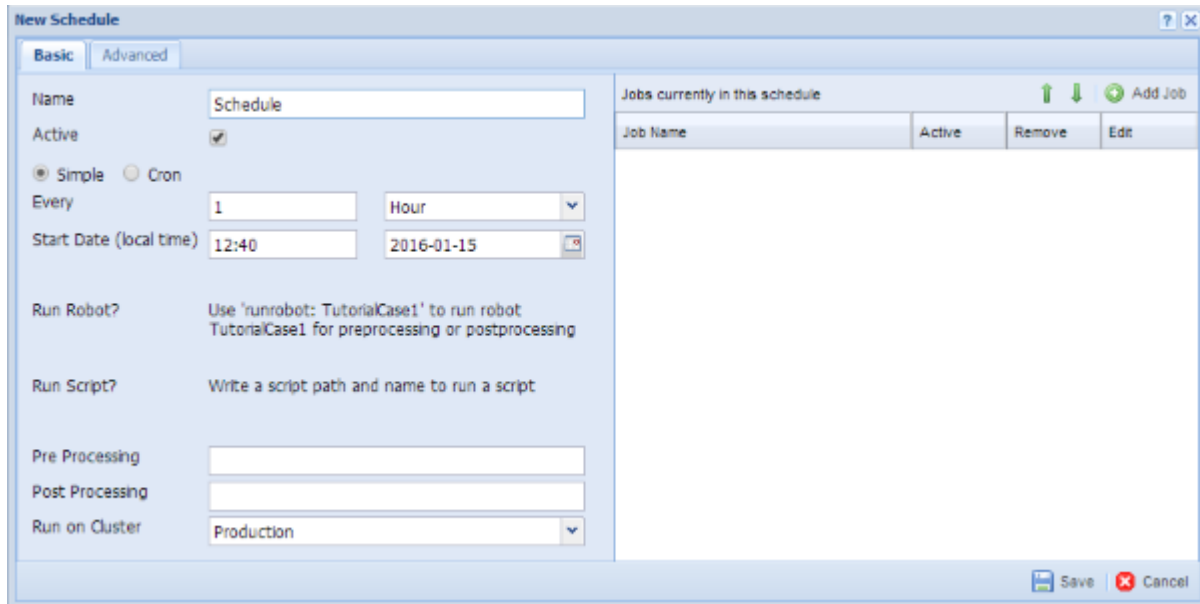

The dialog box contains two tabs: "Basic" and "Advanced". The Basic tab contains everything necessary for setting up a normal schedule. On the Advanced tab you can configure runtime constraints.

The following information can be configured for schedules:

Field	Description
Name	The name of the schedule.
Active	An active schedule is marked with a check mark.
Simple / Cron	Used to select between two different ways of defining the time plan for a schedule.
Every	(Available only for Simple schedules.) The desired time interval between two consecutive runs of the schedule. This is entered as an integral number with a unit, such as "1 minute" or "3 hours".
Pattern	(Available only for Cron schedules.) A pattern defining when the schedule should be run. See Cron Schedule for details of the format.
Pre-processing	The name of a script or robot that will be run as part of the schedule, before any other robots are run. <ul style="list-style-type: none"> To run a script, the "Allow File System and Command Line Access" must first be enabled in the RoboServer settings. These settings are found in the installation folder or from the start menu on Windows. The script file can be a windows .cmd or a Linux.sh file. The field must contain the absolute location of the file, such as c:\scripts\truncatedb.cmd. You must remember to copy the scripts when importing projects or restoring backups. For a robot, use for example runrobot: TutorialCase1 to run the TutorialCase1 robot from the repository.
Post-processing	The name of a script or robot to run as part of the schedule, after all other robots have been run. See pre-processing above for details.

Field	Description
Run on cluster	The name of the cluster to run this schedule on.
Robots (to the right)	See the table with a list of jobs below.
Execution Time Limit (Advanced tab)	Set the maximum execution time for each robot in the schedule. When a robot has executed for this period of time, the server will stop it, and an error will be logged.
Extracted Values Limit (Advanced tab)	Select the maximum number of values each robot may output. If the robot outputs more than this number of values, the server will stop it, and an error will be logged.
Run robots sequentially (Advanced tab)	If checked, the robots will execute in the order listed on the basic tab.
Use Email Notification (Advanced tab)	Check to receive an email whenever a robot fails. If several robots in a schedule fail, you will get one email for each robot each time the schedule runs. Email notification works only if you configure an SMTP server in the Options Tab and enter the desired email addresses in the following field.
Email Addresses (Advanced tab)	A comma-separated list of email addresses to which notifications are sent. The first listed address is used as both a sender and receiver address.

On the right-hand side you see the list of jobs that will run when the schedule triggers.

Column	Description
Job Name	The display name of the job. This is selected when the job is created.
Active	When Active, the job runs when the schedule is run. You may want to make a single job within a schedule inactive for several reasons, such as: <ul style="list-style-type: none"> Because the function performed by the job currently is not needed. Because errors have been found in the robots and you don't want the schedule to run before you have fixed these errors. Because you want to trigger the job manually each time it should run.
Remove	Click to remove the job from this schedule. This will not delete any robots referred to by the jobs.
Edit	Click to edit the job.

To add jobs to the schedule, click  **Add Job** in the upper right-hand corner. This will open a wizard that will take you through the steps of creating a job.

The Help button in the upper right-hand corner of the Schedules tab opens the Management Console help in your browser.

Alternate schedule creation

It is also possible to create a schedule from the [Robots Tab](#). This is done by selecting any number of robots, right-clicking and choosing **Create Schedule** from the context menu. This opens the New Schedule window with the robots already added.

Add Jobs

1. On the New Schedule window, Basic tab, click  **Add Job**.
A wizard appears to guide you through the job creation.
2. On the **Select job type** window, select an option. Available options include "A single robot" and "A group of robots based on name".

Job Type	Description
Single Robot	This option adds a job that runs a single robot. If you need to pass input to a robot, specify the necessary parameters.
Multiple Robots	This option adds a job that runs any number of robots which path name matches a given criteria. The criterion are: "Robot path starts with", "Robot path contains", and "Robot path matches pattern". The robot groups are evaluated every time the schedule starts; therefore, new robots matching the selected criteria will automatically run.

3. Click **Next**.
See the [Add a Single Robot](#) or [Add a Group of Robots](#) topics based on the Job Type you select.

Add a Single Robot

The wizard for adding a single robot contains one to four steps, depending on the robot you select. The wizard follows the flow outlined in this topic. The four rectangles correspond to the four possible steps.

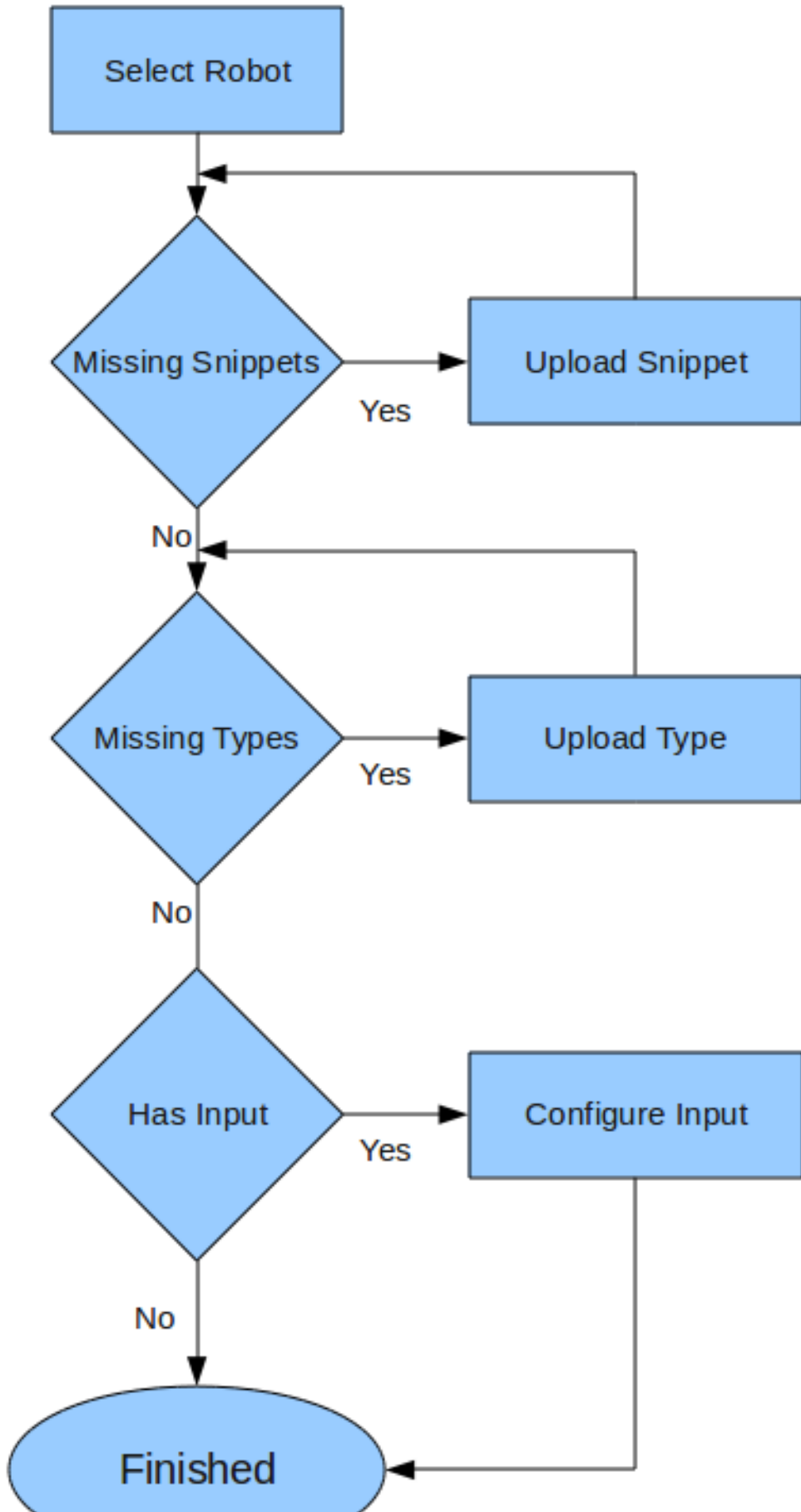

1. Select a robot in the Robot list of the **Select Robot** step.
2. If all snippets and types used by the robot are already uploaded, and the robot does not have any input variables, you can click **Finish**; otherwise click **Next**.
If the selected robot uses any snippets that have not been uploaded to the Management Console repository, you must upload them now.
3. In the "Upload missing snippets" window, browse to the missing snippet and click **Upload**. You can also specify a folder in the "Select folder" list.
If the selected robot uses any types which have not been uploaded to the Management Console repository, you must upload them now.
4. In the " Upload missing types" window, browse to the missing type and click **Upload**. You can also specify a folder in the "Select folder" list.
The configure input for your robot window appears.
5. Configure the robot input used when it runs as part of this schedule.

Configure input for test.robot

alltypes

anInt: 1

aNumber: 1.23

aBoolean:

aCharacter: \$

aShortText: æøåÆØÅ

aLongText: æ

aPassword: ••••

aHTML: <html>bla

Help < Back Next > Finish Cancel

6. If an attribute is of a binary type, you can use the drop down list to select a resource that is already uploaded, or click **Upload** to upload one.
If an attribute is required, it is underlined with red.
7. Complete all required fields and click **Finish**.

Add a Group of Robots

You can select to add a single job that will run all robots with path names that match the given criteria. The criteria is evaluated when the schedule is run, so any robots uploaded after the job is created will be included if they match the configured criteria.

Because the criteria is evaluated at runtime, any errors such as missing snippets/types will be logged as errors in the Schedule Run log. The same is true if a robot that uses input variables is run because it matches the criteria.

The wizard for creating a group based on a path name criteria contains a single step.

The screenshot shows a dialog box titled "Configure criteria". It has a "Display Name:" field containing "Test robots". Below this are three radio button options: "Robot path starts with:" (selected), "Robot path contains:", and "Robot path matches pattern:". The "Robot path starts with:" option has a text input field containing "test". Below these options is a list box labeled "Robots matching criteria:" which contains two entries: "testrobot/NewsMagazine.robot" and "testrobot/SimpleExtract.robot". At the bottom of the dialog, there are buttons for "Help", "< Back", "Next >", "Finish", and "Cancel".

1. On the "Configure criteria" window, select the criteria type. Available options are the following: "Robot path starts with", "Robot path contains", and "Robot path matches pattern".

The list at the bottom will display one or more robots matching the selected criteria. As long as you don't edit the Display Name field, it will change depending on your criteria selection, but once you start editing it, the automatic naming is disabled.

2. Click **Finish**.

You can click **Finish** even if no robots match the configured criteria, since you can later upload a robot that will match.

If you have many robots it may take some time to refresh the list of robots matching the selected criteria.

Note When this job type is added to a schedule configured to run its jobs sequentially, you cannot control the order within the group of robots matching the criteria (but they will be executed sequentially).

Repository

The Management Console keeps a repository of robots, types, snippets, resources and OAuth credentials. Topics in the Repository chapter help you manage your assets.

Note You can filter the list of items in the table by applying filters in the Filter text box. See [Filtering](#) for more information.

Robots

This subsection helps you manage the robots in the repository on a per project basis. In order for robots to be able to run in a schedule, they have to be uploaded to the repository. When the robot is uploaded, it is copied into the repository. Thus, if changes are later made to the robot in Design Studio, it needs to be uploaded again (this can easily be done from within Design Studio). Doing so will not remove the robot from schedules with which it is already associated. Rather, these schedules will use the new version of the robot the next time they run.

Each robot belongs to a project. At the top of the Robots tab, you can select the project for which robots are shown.

Within a given project, you cannot have two different robots with the same name in the repository. They will be considered the same robot, and the one you upload last will overwrite the previous one. Different projects can contain robots with the same name.

The robots are displayed in a table, with a default of 40 robots per page. The information is structured in columns as follows.

Note You can filter the list of items in the table by applying filters in the Filter text box. See [Filtering](#) for more information.

Column	Description
Name	The name of the robot. If the robot uses a type or a snippet which is not present in the repository, the name will be marked in red.
Folder	The name of the folder specified to store the robot files. By default, the files are stored in the Root folder. You can create a new folder to store the files. The folder name is displayed in the column if the selected folder is other than Root. Folders are also shown as part of the robot name in the Robot Runs view on the Logs tab. When deleting a robot, you can delete an empty folder.
Project Name	The name of the project that the robot belongs to (useful when viewing all projects).
Version	The Kapow version last used when editing the robot.
Size	The size of the robot in bytes.
Schedules	The names of the schedules that will run the robot.
Delete	Click to delete the robot from the repository. The robot is automatically removed from any schedules used to run it. If you don't have a copy of the robot in the file system, it is irrevocably lost.

Column	Description
Input Types	Types used in input variables in the robot. To execute the robot, .type files corresponding to each of these types must be present
Returned Types	Types of values returned by the robot. When executing the robot via the API, it may return values of these types. To execute the robot, .type files corresponding to each of these types must be present.
Stored Types	Types of values stored in a database by the robot. To execute the robot, .type files corresponding to each of these types must be present.
Snippets used	Names of the snippets used by this robot. If a robot uses snippet A and snippet A uses snippet B, only snippet A will be listed here.
Created By (hidden by default)	The user name of the user who first uploaded the robot. This feature is only available when running a stand-alone Management Console.
Modified By (hidden by default)	The user name of the user who last modified the robot. This feature is only available when running a stand-alone Kapow.
Last Modified	The date of the most recent modification of the robot.
Run Now	Click this button to start immediate execution of the robot on RoboServer. This feature is not available for robots that take input.
API	Click this button to see an example Java or C# code for executing the robot on RoboServer.
REST	This will open a window that allows you to invoke the robot as a REST service.
SOAP	This will open a window that allows you to invoke the robot via SOAP.
Download	Click to download a copy of the robot from the repository and save it to the file system.

Right-clicking a robot brings up the following menu:

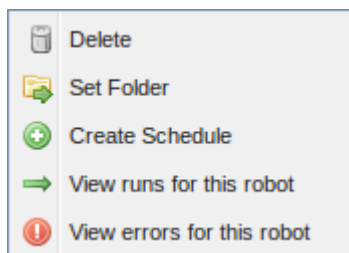

The Delete, Set Folder, and Create Schedule options are available when multiple robots are selected. If you have multiple robots selected and create a schedule, the **New Schedule** dialog box will open with all the selected robots added. If any robot added this way requires input, you will have to add it later.

Clicking **"Add Robot"** in the upper left corner opens a window for uploading a new robot. If you upload a robot with the same name as an existing one, the existing one will be replaced, with no changes to schedules that run it. If you upload a new robot, it is not added to a schedule automatically; you will need to do this yourself.

An alternative way of uploading a robot is to use one of the Upload functions in Design Studio. This works in exactly the same way, except that Design Studio also uploads the necessary types and snippets. If your Management Console Repository contains multiple projects, you will be prompted to choose which project to upload the robot into.

Execute Robots

Once a robot has been uploaded to the Management Console, it can be executed in 4 different ways. Most often you will execute robots as part of a schedule or as a Kapplet, but they can also be executed programmatically either through the Java/.Net APIs or as RESTful services.

API

On the Robots tab, click the API column to access the code generation window, where you can generate template code for Java or .NET.

Before you start using the API to execute robots, we recommend you to read the relevant chapters in the *Kapow Developer's Guide* to understand how the API works.

REST

You can execute robots as RESTful services. This allows you to invoke a robot from any programming language, or directly from a browser using JavaScript.

On the **Repository > Robots** tab you can find a column named REST. Clicking this column brings up a window that allows you to test your robot as a service.

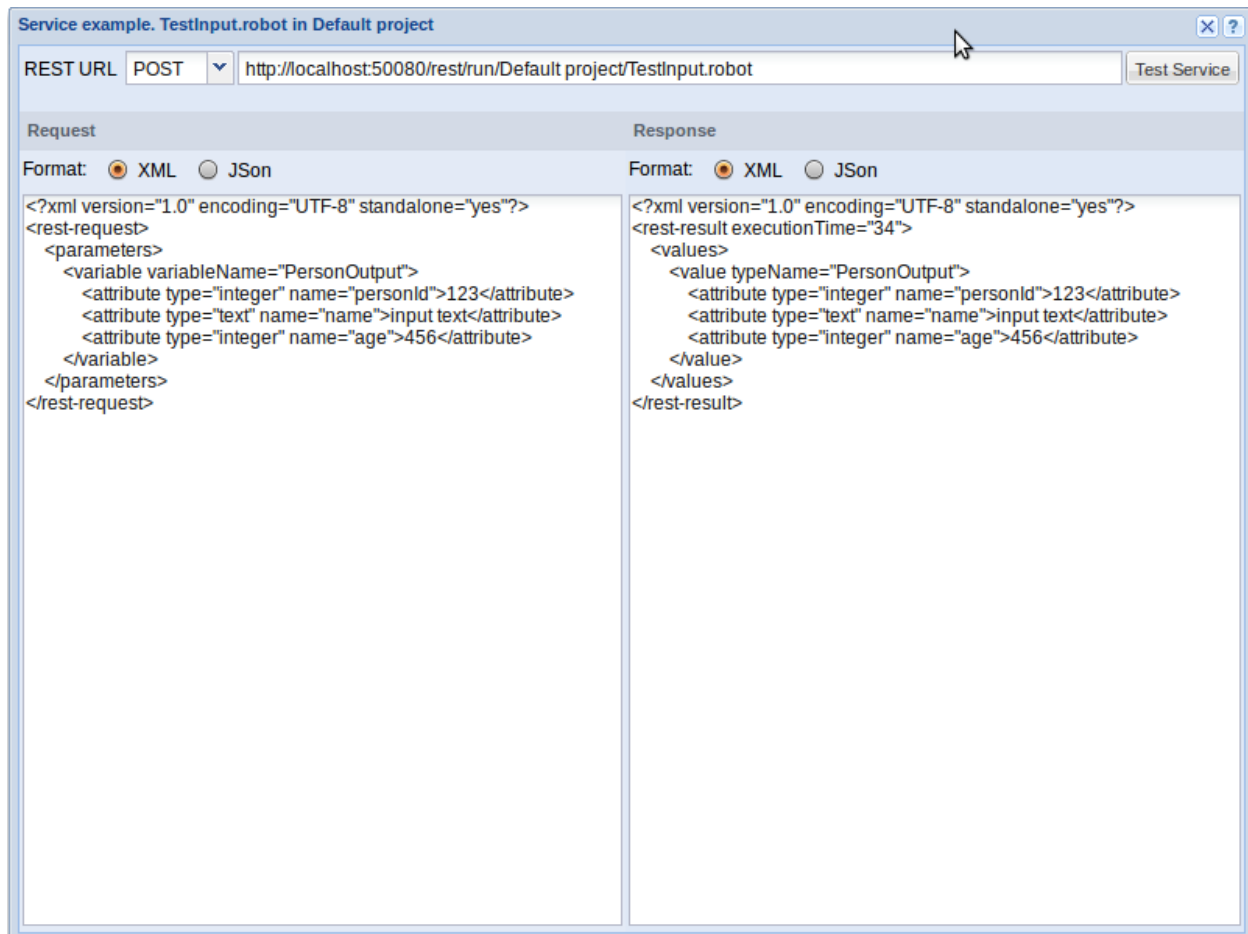

Use the Request pane of the service window to construct a request. Click **Test Service** to execute the robot. The result is then displayed in the Response pane of the window.

The format buttons allow you to configure the formats of the request and responses while testing, but when you call the service from code, the format is controlled by the `Accept` and `Content-Type` HTTP headers. The `Accept` header specifies the desired response format, and the `Content-Type` header specifies the request format.

Robots that require input must be invoked using POST. Robots without input may be invoked using either GET or POST.

REST services are easily invoked from a robot by using the "Call REST Web Service" action.

If the project or robot name contains any non-ASCII characters, make sure that the URL is encoded properly (UTF-8 URL encoding). This is automatically done in robots, but if the service is called from code, the developer is responsible for encoding the URL.

Note Robots that run as services will stop the first time the robot generates an API exception. This is different from scheduled robots, which will continue to run regardless of any API exception generated by the robot. You should think of REST services as something short-lived, such as a Google search or translating a sentence.

Each robot that is run as a service uses a request thread. When the Management Console is running embedded in a RoboServer, there is a maximum of 40 request threads. These 40 threads are used for all types of HTTP requests, such as users accessing the Management Console, uploads from Design Studio, and the Repository API. If you need to run a higher number of concurrent REST services, you will need to install a standalone version of the Management Console on Tomcat so that you can control the number of request threads.

SOAP

Robots can initiate SOAP requests to communicate with programs installed on other computers, pass necessary information, and return a response.

On the **Repository** > **Robots** tab click the SOAP column to access a window for editing and testing your SOAP request.

SOAP example. LongRunning.robot in Default project

Input format: Normal Flat

WSDL URL:

Request URL:

SOAPAction:

Request	Response
<pre><SOAP-ENV:Envelope xmlns:SOAP-ENV="http://schemas.xmlsoap.org/soap/envelope/"> <SOAP-ENV:Header/> <SOAP-ENV:Body> <LongRunning> <inputType1> <test>42</test> </inputType1> </LongRunning> </SOAP-ENV:Body> </SOAP-ENV:Envelope></pre>	

Use the Request pane in the service window to construct a request. Click **Test Service** to execute the robot. The result is then displayed in the Response pane.

Input Format

"Normal" or "flat" refers to the structure of a SOAP request message. For example, if a robot myRobot expects input variables var1 and var2, both of a type that has attributes attr1 and attr2, then "normal" would expect a SOAP message that looks like the following

```
<myRobot>
  <var1>
    <attr1>Some value</attr1>
    <attr2>Another value</attr2>
  </var1>
  <var2>
    <attr1>More input</attr1>
    <attr2>and some more</attr2>
  </var2>
</myRobot>
```

The "flat" structure would require the SOAP message to look as follows:

```
<myRobot>
  <var1__attr1>Some value</var1__attr1>
  <var1__attr2>Another value</var1__attr2>
  <var2__attr1>More input</var2__attr1>
  <var2__attr2>and some more</var2__attr2>
</myRobot>
```

The flat structure was introduced for compatibility reasons.

WSDL URL

The URL for the WSDL of the project that this robot belongs to. Note that this URL is identical for all robots of the same project.

Request URL

When running a robot, an HTTP POST request should be sent to this URL.

SOAPAction

When running a robot, a HTTP header called SOAPAction should be present with the value shown.

Request

This field is pre-filled with an example SOAP message. All input attributes will have default/test values. It can be edited before pressing Test Service.

Response

A non-editable field which contains output from a robot run.

If there are errors in the input parameters or errors during the robot run, a SOAP Fault message is shown (containing a reason and some details for the error).

Important Notes

- Project names can contain characters that are not allowed in WSDL; therefore project names might be different in WSDL/SOAP messages. More specifically, all characters not a-z, A-Z, 0-9, or _ will be replaced by _.
- Similarly, robot names may appear different. They are converted similarly to project names, but when a robot name is changed, a special suffix (such as _1234) is also added.
- Currently SOAP 1.1 is supported.

Types

This subsection lists the types that have been uploaded to the Management Console Repository. At the top of the Types tab, you can select the project which types should be displayed.

When a schedule runs, the robots linked to it are executed on RoboServer. Many robots require types as definitions of either input, output or both. These types must be added to the repository (in the same project as the robot) or running the robot will fail.

When you upload a type to the repository, it is copied into the repository. Thus, if changes are made later to the type in Design Studio, it needs to be uploaded again. Since each type name must be unique (within each project), uploading the type again overwrites the previous version.

You can create database tables from types.

Multiple types with the same name can be uploaded only if they are placed in separate projects.

Note You can filter the list of items in the table by applying filters in the Filter text box. See [Filtering](#) for more information.

The following information is displayed for each type.

Column	Description
Name	The name of the type.
Folder	The name of the folder specified to store types. By default, the files are stored in the Root folder. You can create a new folder to store the files. The folder name is displayed in the column if the selected folder is other than Root. When deleting a type, you can choose to delete an empty folder.
Size	The size of the type in bytes.
Project Name	Displays the project the type belongs to (useful when viewing all projects).
Delete	Click to delete the type from the Repository. If you don't have a copy of the type in the file system, it is irrevocably lost.
Last modified	The timestamp for the last change of this type.
Download	Click to download a copy of the type from the Repository and save it in the file system.
Created By (not shown by default)	The user name of the user who first uploaded the type. This feature is only available when running a stand-alone Kapow using LDAP.
Modified By (not shown by default)	The user name of the user who last modified the type. This feature is only available when running a stand-alone Kapow using LDAP.

1. Click **Add Type** in the upper left corner
The Upload type window appears.

Note Types may implicitly be uploaded with the aid of Design Studio. This happens when you use Design Studio to upload a robot that uses the type. Because Design Studio knows about the dependencies between robots and types, it always uploads the necessary types along with the robot.

- To remove a type, click in the **Delete** column.
You will be prompted to confirm the deletion. If the type is used by a robot or snippet, the confirmation message will include the usage count. If you delete a type that is used by a robot or snippet, the robot (or robots using the snippet) will no longer be able to execute. You can also delete an empty folder.

Create Database Table from Types

To create a database table from one or more types uploaded to the Management Console, follow the procedure.

- Select one or more types on the Types tab under the Repository tab.
- Right-click the selected types and choose **Create database table**.
The Create table window appears.
- In the Create table window, select one of the configured database mappings defined in a project and select whether to generate SQL code to drop tables. Click **Generate SQL**.
A SQL editor opens, containing SQL code to generate (and drop if you selected **Generate SQL to drop tables**) the tables from the selected types on the selected database. Edit the code and click **Execute SQL**.

After the SQL code has been executed, a message is issued with an execution state (success or errors with description). Click **OK** to dismiss the message and close the windows.

Snippets

This subsection lists the snippets that have been uploaded to the Management Console Repository. At the top of the Snippets tab, you can select the project which snippets should be displayed.

When a schedule runs, the robots linked to it are executed on RoboServer. Some robots use snippets, which must be available in the repository (in the same project as the robot) or running the robot will fail.

When you upload a snippet to the repository, it is copied into the repository. Thus, if changes are later made to the snippet in Design Studio, it needs to be uploaded again. Since each snippet name must be unique (within each project), uploading the snippet again overwrites the previous version.

Note You can filter the list of items in the table by applying filters in the Filter text box. See [Filtering](#) for more information.

The following information is displayed for each snippet.

Name	Description
Name	The name of the snippet.

Name	Description
Folder	The name of the folder specified to store snippets. By default, the files are stored in the Root folder. You can create a new folder to store the files. The folder name is displayed in the column if the selected folder is other than Root. When deleting a snippet, you can delete an empty folder.
Input Types	Displays the project the snippet belongs to (useful when viewing all projects).
Returned Types	Types used in input variables in the snippet. To use this snippet in a robot, the .type files corresponding to each of these types must be present.
Stored Types	Types of values returned by the snippet. To use this snippet in a robot, the .type files corresponding to each of these types must be present.
Snippets used	Types of values stored in a database by the snippet. To use this snippet in a robot, the .type files corresponding to each of these types must be present.
Size	Name of the snippets used by this snippet. If a snippet uses snippet A and snippet A uses snippet B, only snippet A will be listed here.
Delete	The size of the snippet in bytes.
Created By (hidden by default)	Click to delete the snippet from the Repository. If you don't have a copy of the snippet in the file system, it is irrevocably lost.
Modified By (hidden by default)	The user name of the user who last modified the snippet. This feature is only available when running a stand-alone Kapow using LDAP.
Last modified	The timestamp for the last change of this snippet.
Download	Click to get a copy of the snippet out of the Repository and save it in the file system.

1. To add a snippet, click **Add Snippet** in the upper left corner.

The "Upload snippet" window appears.

You may upload multiple snippets by the same name only if they are placed in separate projects.

Note Snippets may implicitly be uploaded with the aid of Design Studio. This happens when you use Design Studio to upload a robot that uses the snippet. Because Design Studio knows about the dependencies between robots and snippets, it always uploads the necessary snippets along with the robot.

2. To remove a snippet, click in the **Delete** column.

You will be prompted to confirm the delete. If the type is used by a robot or snippet, the confirmation message will include the usage count. If the snippet is used by other snippets or robots, the confirmation message will include the usage count. If you delete a snippet that is used by a robot (or a snippet used by this robot), the robot will no longer be able to execute. Any robot that is missing a required snippet, will be listed with its name in a red font on the Robots tab. When deleting a snippet, you can delete an empty folder.

Resources

This tab shows the resources uploaded to the Management Console. These resources can be used as input for scheduled robots that have an input variable with binary attributes. (See [Using Local Files in Robots](#) for information on how to add and load such a variable to the robot.)

Note You can filter the list of items in the table by applying filters in the Filter text box. See [Filtering](#) for more information.

The following information is displayed for each resource.

Column	Description
Name	The name of the resource.
Folder	The name of the folder specified to store resources. By default, the files are stored in the Root folder. You can create a new folder to store the files. The folder name is displayed in the column if the selected folder is other than Root. When deleting a resource, you can delete an empty folder.
Size	The size of the resource in bytes.
Project Name	The name of the project the resource belongs to (useful when viewing all projects).
Delete	Click to delete the resource from the Repository. If you don't have a copy of the resource in the file system, it is irrevocably lost.
Download	Click to download a copy of the resource from the Repository and save it to the file system.
Created By (not shown by default)	The user name of the user who first uploaded the resource. This column will only contain relevant information when running a stand-alone version of Kapow that has an individual user login.
Modified By (not shown by default)	The user name of the user who last modified the resource. This column will only contain relevant information when running a stand-alone version of Kapow that has an individual user login.

1. In the upper left corner of the tab, click **Add Resource**.
The Upload resources window appears.
2. Browse for the file to upload.
3. Select a project from the Into Project list.
4. Click **Upload**.

Resources added in the dialog box for configuring input for a scheduled robot, or added directly from Design Studio are then uploaded.



Device Mappings

This tab shows mapped Automation Devices available for robots. You can create [mappings](#) to the devices on this tab from the Design Studio.

Note You can filter the list of items in the table by applying filters in the Filter text box. See [Filtering](#) for more information.

The following information is displayed for each device mapping.

Column	Description
Mapping	Name of the device mapping.

Column	Description
Label	Label of the device mapping. You can use the labels to filter the devices you want to automate with your robot.
Edit	Click  to modify mapping settings in the Edit Device Mapping dialog box.
Delete	Click  to delete the mapping from the Management Console.

To create a new Automation Device mapping, click **New Device Mapping** on the Device Mappings tab, specify the new mapping name and labels, and click Save.



Databases

This tab lists database mappings of the selected project. You can link your robot to different databases in a cluster by using mappings and you can create new mappings on this tab. Database mappings have project scope; you cannot have database mapping objects with the same name in one project. After you install Kapow, a default database mapping "objectdb" is added to the Default Project, which is pointing to the Production cluster's default Development Database.

Important Database mapping in the Management Console was introduced in version 9.6.0. Previous versions of RoboServers would not be able to use it, but instead will use the pre 9.6 version mechanism of connecting to the database.

You can use space, parentheses, and hyphens for database mapping names. For example, "Development Database (MySQL)" is a valid database mapping name.

Note You can filter the list of items in the table by applying filters in the Filter text box. See [Filtering](#) for more information.

Column	Description
Name	Database mapping name.
Project Name	The name of the project that the mapping is assigned to (useful when viewing all projects).
Database	Name of the database the object is mapped to.
Cluster	Name of the cluster the object is mapped to.
Edit	Click  to modify mapping settings in the Edit Database Mapping dialog box.
Delete	Click  to delete the mapping from the Management Console.
	<p>Note If you delete the last mapping of a database, this database will not be available in the Design Studio even if a cluster has been selected to provide Design Studio with shared databases.</p>

For more information on database mapping, see [Map Databases](#) in the [Design Studio](#) section.

OAuth

This tab contains the OAuth applications and users that have been authenticated using the Management Console. The credentials of the users can be used as input to robots in a schedule, allowing them to access APIs on behalf of the authenticated user without having access to the username and password.

Please consult the [OAuth section](#) of the documentation for more information on how to create and manage robots that access APIs that are protected by OAuth.

Data

The Data view allows you to view and export data extracted by Robots.

In the upper left corner of the Data view, you can see the Database navigation tree along with a project selector. You can view data from the databases for each project. To view data from a given project, select it, and the database mappings defined in that project will be shown in the database navigation tree. Next to the project selector is a refresh button for use when the databases have changed, in which case it will re-populate the database navigation tree to show the new information.

When you click a database mapping name, the tree opens, and you can see the various schemas in the database. When you click a schema you can see the Kapow tables in that schema. When you click a table, the contents of that table are loaded into the data grid on the right pane. Once the data is loaded, a number of filters become visible in the Filters window. The filters work exactly like the filters on the [Logging Tab](#). Binary and `longtext` attributes are not filterable.

If you click the Delete column, a window will open allowing you to delete one or more rows for the table. Double clicking a row will bring up a window with the content of that row, allowing you to copy the data.

Above the data grid, you can see an Export bar, containing 4 buttons. The first 3 buttons allow you to export the table data to either Excel, XML, or CSV format. The fourth button allows you to see previous export, and download them again. The exports are automatically deleted the next time the Management Console starts, also the oldest exports are deleted when the number of exports exceeds 100. There is no limit to the number of rows you can export to CSV or XML, but Excel files are limited to 10000 records, to prevent the system from running out of memory.

The list of schemas/catalogs available under each database in the navigation tree, is controlled by the permissions of the user who's credentials are used (in the cluster settings database configuration).

Logs

This tab is used to view the logs created by the Management Console and by the RoboServers' database logging. The Schedule Runs and Schedule Messages are Management Console logs that report information on schedules. The remaining logs are RoboServer logs containing information on the status of the RoboServers and on robots and robot runs. Both the Management Console logs and the RoboServers logs are written to the logging database, thus requiring that a logging database be set up in the Management Console settings (see [Log Database](#)) and that database logging is enabled on the RoboServers via the [logging cluster settings](#).

Errors	Robot Errors	Schedule Name	Run Id	Project Name	Start	Stop	MC Server	Warnings	Delete
0	0	Copy of Schedule3	11757	Default project	2012-04-16 16:19:00	2012-04-16 16:19:33	kg-linux	0	[Delete]
0	0	Schedule1	11758	Default project	2012-04-16 16:19:00	2012-04-16 16:19:00	kg-linux	1	[Delete]
0	0	Schedule15	11759	Default project	2012-04-16 16:19:00	2012-04-16 16:19:00	kg-linux	1	[Delete]
0	0	Schedule3	11760	Default project	2012-04-16 16:19:00	2012-04-16 16:19:00	kg-linux	1	[Delete]
0	0	Schedule4	11761	Default project	2012-04-16 16:19:00	2012-04-16 16:19:33	kg-linux	0	[Delete]
0	0	Schedule5	11762	Default project	2012-04-16 16:19:00	2012-04-16 16:19:28	kg-linux	0	[Delete]
0	0	Schedule9	11763	Default project	2012-04-16 16:19:00	2012-04-16 16:19:00	kg-linux	1	[Delete]
0	0	Copy of Schedule3	11748	Default project	2012-04-16 16:18:00	2012-04-16 16:18:21	kg-linux	0	[Delete]
0	0	Schedule1	11749	Default project	2012-04-16 16:18:00	2012-04-16 16:19:24	kg-linux	0	[Delete]
0	0	Schedule11	11750	Default project	2012-04-16 16:18:00	2012-04-16 16:19:32	kg-linux	0	[Delete]
0	0	Schedule14	11751	Default project	2012-04-16 16:18:00	2012-04-16 16:18:50	kg-linux	0	[Delete]
0	0	Schedule15	11752	Default project	2012-04-16 16:18:00	2012-04-16 16:19:23	kg-linux	0	[Delete]
0	0	Schedule2	11753	Default project	2012-04-16 16:18:00	2012-04-16 16:18:00	kg-linux	1	[Delete]
0	0	Schedule3	11754	Default project	2012-04-16 16:18:00	2012-04-16 16:19:33	kg-linux	0	[Delete]
0	0	Schedule5	11755	Default project	2012-04-16 16:18:00	2012-04-16 16:18:30	kg-linux	0	[Delete]
0	0	Schedule9	11756	Default project	2012-04-16 16:18:00	2012-04-16 16:19:06	kg-linux	0	[Delete]
0	0	Copy of Schedule3	11741	Default project	2012-04-16 16:17:00	2012-04-16 16:17:05	kg-linux	0	[Delete]
0	0	Schedule1	11742	Default project	2012-04-16 16:17:00	2012-04-16 16:17:00	kg-linux	1	[Delete]
0	0	Schedule15	11743	Default project	2012-04-16 16:17:00	2012-04-16 16:17:00	kg-linux	1	[Delete]
0	0	Schedule3	11744	Default project	2012-04-16 16:17:00	2012-04-16 16:17:00	kg-linux	1	[Delete]

You select one of the log views, by clicking the icon next to the log to view.

The page layout for each log is identical. When you click the a number of filters are displayed to the left, and the data is loaded into the grid to the right. A "Results per page" field is available under the filters.

The screenshot shows a light blue control panel. On the left, the text 'Results per page:' is followed by a text input field containing the number '20' and a small downward-pointing arrow icon. Below this are three buttons: 'Add Column', 'Reset', and 'Update', each with a light blue gradient and rounded corners.

- Add Column adds columns to and removes columns from the grid to the right.
- Reset clears any filter configuration entered.
- Update loads the grid with data based on the configuration of the filters.
- The list box controls the number of results per page (for the next update).

If there are more results than the number selected per page, you can navigate to the next page using the controls under the data grid. Pressing Enter in any filter text field triggers an update of the grid.

You can set up the retention policy for your logs in the [RoboServer Log Database](#) by specifying a number of days to keep the logs and a number of messages in the robot run. The logs are cleaned on a daily basis by deleting the oldest messages first. The default values are 10 days and 500 messages.

Schedule Runs

Displays execution information for each schedule that executes, such as when the schedule started and when it finished.

Use the context menu to navigate to the individual schedule message, or to the robots that were executed as part of this schedule run.

If you click in the Delete column, a window opens to delete the run and messages. When deleting, you always have to delete the messages, but you can keep the run information if you like. You can delete this run and messages, or all runs or messages matching the current filter. Deleting many runs or messages might take some time.

Schedule Messages

Displays individual message entries for a given schedule run. This allows you to see exactly why a schedule failed to run.

Note To find robot errors for a given schedule run, select "View robot view errors" from the context menu.

You can delete one or more records by clicking the Delete column. This will open a window in which you can select to delete only this message, all messages matching the current filter, or all RoboServer log messages (the option to delete message matching a filter is disabled if there are more than 500 matching results. This is due to performance).

Note To see Schedule Runs and Schedule Messages, set up log database (see [Log Database](#)) and enable logging on the RoboServers via the [logging cluster settings](#).

RoboServer

Displays general messages from RoboServer or the Management Console. Double-click or use the context menu to open the message in a separate window, making it easier to copy the error message.

You can delete one or more records by clicking the Delete column. This will open a window in which you can select to delete only this message, all messages matching the current filter, or all RoboServer log

messages (the option to delete message matching a filter is disabled if there are more than 500 matching results. This is due to performance).

Robots

This is a simple summary view of all robots ever run (for as long as data is available). If you double-click a row or use the context menu, you will navigate to all runs for the given robot.

Robot Runs

Displays information for each robot run. This log contains a number of extra fields that are not shown by default, but can be added by clicking the Add Column below the filters. Double-clicking a row takes you to all messages logged during this run, which is also available through the context menu. The context menu also allows you to view all runs for the same robot, or view the input this robot was given when this run was executed.

If you click the Delete column, a window opens allowing you to delete the run and messages. When deleting, you always have to delete the messages, but you can keep the run information if you like. You can delete this run and messages, or all runs or messages matching the current filter. Deleting many runs or messages might take some time.

Robot Messages

Displays individual error messages belonging to a robot run. Double-clicking a row brings up a window that allows you to easily copy the error message. Using the context menu, you can navigate to the run this message belongs to.

For robot errors, the Location Code column in the data grid contains a link. When you click the link a small .robotDebug file is downloaded. If you open the file with Design Studio, the robot will be loaded, the input from the run will be set, and the robot will navigate to the location of the error, allowing you to quickly debug errors.

Admin

Use this tab to administer the Management Console.

Task View

Display the robots and other tasks executed by the Management Console.

RoboServers

Add or delete RoboServers and clusters, and configure cluster settings. View running robots.

Devices

View available Automation Devices registered with the Management Console.

Projects

Create and delete projects.

Users

View information on the Management Console users.

Settings

Configure Management Console settings.

Backup

Create and restore backups and import/export projects.

License

Enter license information or view information on the current license and Design Studio seats in use.

Task View

The Task view shows the scheduled robots, as well as pre- and post-processing tasks that have been started by the Management Console's Scheduler. The Task view gives an overview of the current activity across all servers and robots; if you want to know about the outcome of previous robot runs, you should inspect the [Logs](#).

Because of update delays, short-running robots may never (or almost never) appear on this tab.

The following information is displayed for all currently running robots.

Column	Description
Name	The name of the task that is running.
Schedule	The name of the schedule that the task runs within.
Project Name	The name of the project that the task belongs to.
Status	<p>The task may be in one of the following states:</p> <p>Queued The task is queued and waiting for execution. A task may be queued for the following reasons:</p> <p>No Servers There are currently no servers in the cluster, or all servers are offline. The task will start to execute when a server is added, or an offline server comes online.</p> <p>No Capacity All servers are executing at maximum capacity. The task will start to execute when other tasks finish and capacity becomes available, or if additional server are added to the cluster.</p> <p>Waiting for other task The task may be waiting for another task to finish. Post-processing may not be run until all robots have finished, and robots may not be run before pre-processing has finished. Also, if robots on a schedule are configured for sequential execution, robots will remain queued until the previous robot completes.</p> <p>Running The task is currently executing.</p>
Last status change	The time of the last status change.
Stop	Click to stop the task even though it has not finished running.
Input	This column shows a summary of inputs for the running robot.



Note When you point to a column, a pop-up text shows all the available information whereas the text in the actual column is usually shortened due to lack of space.

RoboServers

This section enables you to manage clusters and RoboServers known to the Management Console. All servers in the list can be monitored using the portlets on the Dashboard. By default, the list contains one cluster containing one RoboServer, namely the one that also runs the Management Console functionality. In larger setups with multiple RoboServers and clusters, we recommend that the Management Console be deployed on a standalone web container (if license permits), or on a RoboServer that is not used for running robots. See the *Kapow Administrator's Guide* for additional information about configuring the Management Console.

The following information is displayed for each server. Note that for RoboServers version earlier than 9.4, some of the information is not available.

Column	Description
Cluster/Server	<p>For Clusters The name of the cluster that is suffixed by SSL if the cluster uses SSL. If the cluster has unapplied settings, they are also shown here in blue. If the cluster has invalid settings, the name will be displayed in red.</p> <p>For RoboServers The name and port of the RoboServer. If the RoboServer is incorrectly configured, the name will be displayed in red. If you hover over the red name, a tooltip will inform you of the error.</p>
Version	The version of the software on the running RoboServer.
KCU	The number of KCUs assigned to this cluster. KCUs in a cluster are distributed evenly between online RoboServers in the cluster. To adjust the KCUs on a cluster, click the Assign KCUs button.
Running Robots	The number of robots currently running on the RoboServer.
Queued Robots	The number of queued robots on the RoboServer
Max Robots	The maximum number of concurrent robots on the RoboServer. Can be configured in the Clusters settings.
Uptime	The uptime of the RoboServer. Allows you to see when the server was started or restarted.
Command line (hidden)	The command line the RoboServer was started with.
CPU count (hidden)	Number of CPUs assigned to the RoboServer process, for example if CPU affinity has been assigned.
Memory Limit	The maximum amount of memory assigned to the JVM the RoboServer runs in.
Above Limit	Shows whether the server is operating above its memory threshold (80% default). If this limit is reached, the RoboServer will queue the robot instead of starting it.
Duration (Accum.)	Shows the total time the RoboServer has been in the Above Limit state.
Max Queue (hidden)	The maximum number of robots that can be queued on the RoboServer. Can be set in the Clusters settings.
License Type	The license type of the RoboServer: Production or Non-Production.
Cluster Mode/Server Status	For clusters, shows the Cluster Mode. For RoboServers, shows if the server is Online or Offline.
Temp Profiling	Indicates whether profiling has been temporarily enabled for a given server. The setting will be cleared upon server restart.

Column	Description
Last Updated	Click to delete the cluster/server from the Management Console. This will remove any associated information from the Dashboard portlets.
Settings	Click  to modify cluster settings in the Cluster Settings dialog box.
Delete	Click Delete  to delete the cluster/server from the Management Console. This will remove any associated information from the Dashboard portlets.

The Robot Runtime view contains detailed information about running robots. The top bar of the Robot Runtime view contains the following:

- Robot on: - Shows which cluster or server the view currently displays robots for.
- Filter by - Helps you to filter the list by Robot, Project, or Execution Id, or to disable the filter by selecting the blank line. Filter matching is case sensitive and the filter will select those robots that contain the entered text as a substring in either the Robot, Project, or Execution Id field.
- Robots per page - Limits the maximum number of robots displayed on a page.
- Refresh Every - Sets the refresh rate of the view (default is one second).

Click the column header to sort any column in ascending or descending order. The default sorting is by Start Time Client.



Double-click a row in the table to open the Robot's information in a window. The window shows the same information available in the Robot Runtime view that it is a snapshot of the information at the time you open the window. The information is not updated even if the robot stops executing.

Click Refresh  to refresh the information in the table.

The following information is displayed for each running or recently completed robot. The table shows Robots either from one RoboServer or from all RoboServers if a Cluster is selected.

Column	Description
Robot	Name of the robot
Server	Name of the server that runs the robot
Project	Name of the project that the Robot belongs to. View the list of projects on the Repository > Robots tab.
Robot URL	<p>A URL that the Robot is identified by. When you build the execute request for a RoboServer, you can either specify a file://URL or a Library:/, which specifies whether the robot should be loaded from the file system or the library.</p> <ul style="list-style-type: none"> ▪ File system URL - file://C:/Kapow/Robots/Library/Input.robot ▪ The Library URL - Library:/Input.robot <p>The execute request for a Robot may look like this:</p> <pre>Request request = new Request("Library:/Input.robot")</pre>

Column	Description
Robot Library	<p>A type of Robot library. The following types exist:</p> <ul style="list-style-type: none"> ▪ Design Studio Robot Library ▪ Embedded File-based Robot Library ▪ Repository Robot Library ▪ URL File-based Robot Library ▪ URL Folder-based Robot Library <p>See "Programming with Robots" in the <i>Kapow Developer's Guide</i> for more information. Also see Robot Libraries in the Reference section of this help system.</p>
Start Time Client	The time when the Robot was started. The time is displayed in time zone of the browser running the Management Console.
Execution ID	Robot execution ID.
Current Step	The step the Robot is currently executing.
Execution Path	The sequence of steps the Robot has performed.
Location Code	A code assigned to a step that you can view in Design Studio.
Step Execution Time	Current step execution time in seconds.
Executed Steps Limit	Shows the maximum number of steps the robot is allowed to execute. If the limit is reached, the robot is stopped.
Status	<p>Robot's current status.</p> <ul style="list-style-type: none"> ▪ Running - Currently running ▪ Queued - Queued for running when possible ▪ Completed - Finished executing on RoboServer. This status is assigned to Robots that: <ul style="list-style-type: none"> ▪ Completed successfully ▪ Completed with errors ▪ Failed ▪ Were forced to stop <p>Robots with Completed status are removed from the table after one minute from completion.</p>
KCU Point Cost	KCU points spent for running the Robot. KCU Point Cost is equal to KCU-Point Usage from Design Studio.
KCU Wait	Amount of time the Robot has been unable to execute because the KCU Points (for this second) had already been spent.
Loaded Bytes	Bytes loaded during a Robot execution.
Extracted Values Limit	An upper limit on the number of object extractions. If the robot extracts more objects than indicated by this property, then an error message is generated or the robot is stopped.
Execution Time Limit	An upper limit on the total robot execution time. If the robot does not complete within this time limit, then an error message is generated and the robot is stopped. The property value is specified in seconds.
Last Output Time	The time when the last extraction was performed.
Emails Sent	The number of emails sent by the robot.
Stopping	Whether the robot is in the process of shutting down.
Output Count	The number of objects that the robot has generated.

Column	Description
Executed Steps	The number of steps the robot has executed.
Stop If Connection Lost	When this flag is set, the robot will stop if it loses the connection to the Management Console.
Stop On API Exception	When this flag is set, the robot will stop if it generates an API exception.
Log	Click  to open the Log tab.
Stop	Click  to stop robot execution.
Schedule	Click  to open the Edit Schedule dialog box.

Create a Cluster

When you create a cluster, specify the name of the cluster and the cluster type. If you create a non-production cluster, you can assign KCU from the non-production license, and similarly if you create a production cluster, you can assign KCU from the production license. If you select the SSL option, all RoboServers in the cluster must use the SSL RQL service.

After creating a cluster, you can add RoboServers to the cluster.

Context Menu

The grid contains a context menu, which has rarely used functionality that is not available from the bottom menu. The following are context menu items:

Cluster Settings

Brings up the [Cluster Setting](#) dialog box.

Stop RoboServer

Brings up a dialog box that allows you to stop/reboot the selected RoboServer.

Dump Threads

Sends a request to the selected RoboServer to perform a full thread dump, which opens in a separate window. It is also possible to get a thread dump of the Management Console. For details see "Tomcat Management Console" in the *Kapow Administrator's Guide*.

Load Distribution and Failover

When a cluster needs to execute a robot, it finds the RoboServer with the highest number of available slots. Available slots are calculated based on how many robots are already running on the RoboServer and how many robots it can run concurrently (the maximum concurrent robots in the [Clusters Settings](#).)

If a RoboServer in a cluster goes offline, the KCU is automatically distributed evenly among the remaining RoboServers.

Change the Cluster Mode

You can set three different modes to a cluster: Normal, Maintenance or Pending Maintenance. The Maintenance mode is used to set clusters into a mode where nothing is run on them. The point is to be able to update [cluster settings](#) in a way that ensures that all robots in a given schedule use the same settings, and that settings are not changed in the middle of schedule runs. The table below explains the different modes.

Cluster Mode	Description
Normal	Cluster operates normally with schedules and individual robots executed as expected. Cluster settings are not "applied" to the RoboServers so that settings are not changed in the middle of schedule runs.
Maintenance	No robots are allowed to run on the cluster (unless initiated from the API, as described after the table). For cluster settings to be applied to the RoboServers, a cluster MUST be in Maintenance mode.
Pending Maintenance	<p>When you select one of the following ways to set a cluster to Maintenance mode, Pending Maintenance mode goes into effect until all robots stop running on the cluster.</p> <p>Stop All Robots and Schedules Now Attempts to stop all currently running robots. Any queued robots are de-queued and not run. This is the fastest way of setting a cluster to Maintenance mode.</p> <p>Finish Currently Running Tasks and Stop Ensures that all robots that have been started and are currently running will finish before the cluster goes into Maintenance mode. A schedule running several robots where some are queued and some running, will only have its currently running robots run; any queued robots are de-queued.</p> <p>Finish Currently Running Schedules and Stop Ensures that all running and queued robots are finished. This means that any started schedules will finish before the cluster is set into Maintenance mode.</p>

1. Click **Change Cluster Mode** above the cluster list.

The Change Cluster Mode window appears.

Note You can also right-click a cluster in the list and select the appropriate submenu item.

2. In the **Cluster** field, select the cluster to change.
3. In the **Cluster Mode** field, select a Maintenance option to transition into Maintenance mode.
The cluster modes are, as the name implies, only relevant on a cluster level. As such, they are a way for the Management Console to control when tasks can be executed on clusters. They do not, however, control the individual RoboServers. This means that robots started from the API are not stopped when going into Maintenance mode. Therefore, the settings of a RoboServer can be updated while API robots are running. It is guaranteed, though, that a robot will not have its settings updated during its execution. For instance, if databases are updated while one or more API robots are running, the robots will use the databases that were configured when they started. Next time they are run, they will use the new settings.

Configure Cluster Settings

The cluster settings are sent to each RoboServer in the cluster. Through the cluster settings one can configure, for instance, which databases are available for robots executing on the RoboServers.

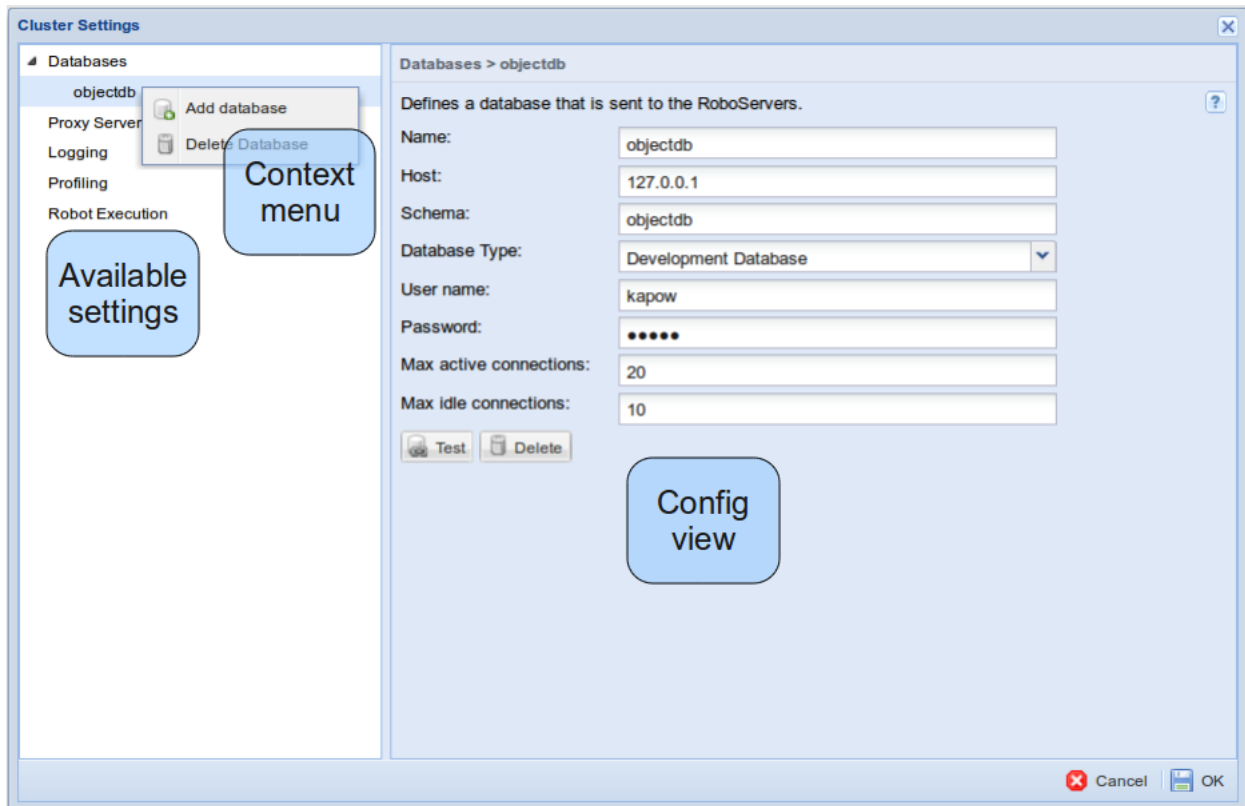

1. Right-click a cluster and select **Cluster Settings**.

Optionally, in the **Settings** column, click .

The Cluster Settings window appears.

2. Configure the options as needed.

Note When modifying the cluster settings, any changes are indicated in bold so that one has an overview of the changes made before confirming by clicking OK.

3. Click **OK**.

In order for the settings to be sent to the RoboServers, they must first be applied. Applying settings is done by setting the cluster into maintenance mode (see [cluster modes](#) for more information). If the cluster is in maintenance mode, when you click OK, the settings are applied right away. If the cluster is not in maintenance mode, the following window appears:

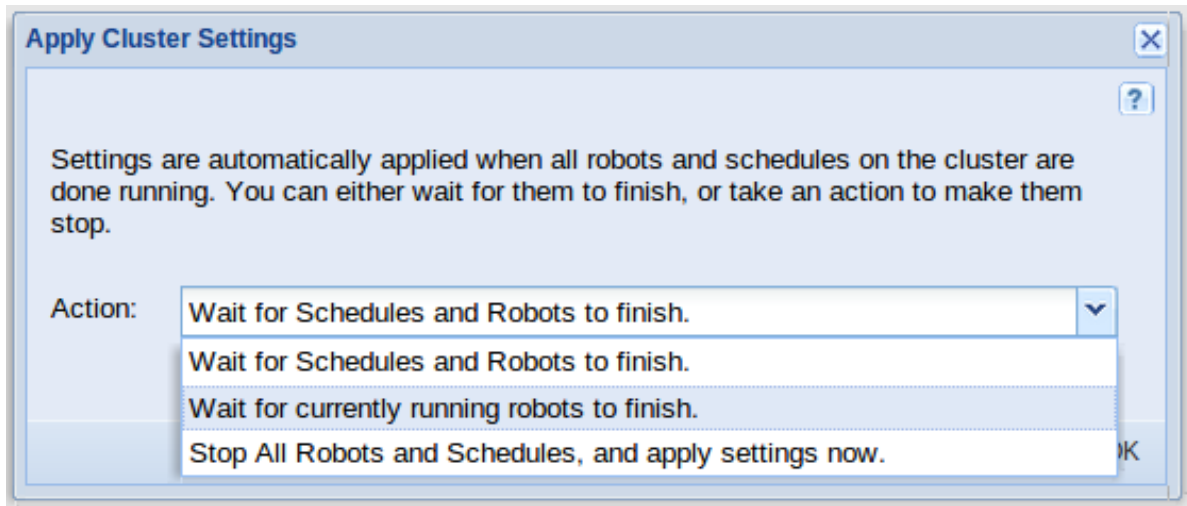

4. In the Action field of the Apply Cluster Settings window, select how you want to transition the cluster into Maintenance mode in order to apply settings.

When the settings are applied, the cluster returns to Normal mode.

Cluster Databases

You can add or delete a database on the Databases menu of the [Cluster Settings](#) window.

The databases defined on a cluster are available to robots running on the cluster RoboServers via [database mappings](#). A database uses a database type. Database types are defined in the [Management Console settings](#).

If a cluster is selected to provide Design Studio with [Shared Databases](#) and [database mappings](#) pointing to these databases exist in the [Repository](#), the databases that are defined on the cluster are also available in Design Studio. You can check database mappings on the **Repository > Databases** tab.

For users upgrading from pre 9.2.0 versions, it is possible to import databases from the legacy db.properties files in which databases were previously defined. This is done by selecting the Databases node in the tree, and clicking **Import Databases From File**. This will open a window in which the contents of the file can be pasted.

See [Database Connections](#) for more information on database properties.

To add a new database, you can either select the database category, and click **Add Database**, or right-click the database category and click **Add**.

Note To connect to a specific database, Kapow needs the JDBC driver for this database type. The driver can be downloaded from the provider of the database. For example, `sqljdbc4.jar` that is used with a Microsoft SQL Server database can be downloaded from the Microsoft website. To provide the driver for Kapow to use, upload it to the Management Console under **Admin > Settings > Database Drivers > Upload Driver Jar**.

By default, you can upload driver jars to the Management Console when you connect to it as administrator from localhost (otherwise, the Upload Driver Jar button is disabled). This setting can be changed in **RoboServer Settings > Management Console tab > JDBC Driver Upload**. Important: start RoboServer Setting as the user running the Management Console process. After making changes in the RoboServer Settings, restart the Management Console for the changes to take effect.

The **Add Development Database** button creates a database connection to the pre-installed Kapow development database.

1. On the **Cluster Settings > Databases** window, select **Add Database**.
Optionally, you can right-click the database category and click **Add**.

Note To import databases from legacy properties files, select the database category and click **Import Databases From File**.

When the window appears, paste the contents of the file to import.

2. Complete the following database detail.
 - Name
 - Host
 - Schema
 - Database Type
 - User name
 - Password
 - Max active connections
 - Max idle connections
3. Click **Test**.
4. Click **OK**.

Proxy Servers

You can configure a list of proxy servers to use on the RoboServers. If only a single proxy server is defined, that one is used. If a list of proxy servers is defined, for the first connection a random proxy server is selected. The following connections then use the proxy servers in round-robin order.

See [Using Proxy Services](#) for more details on using proxy and [Design Studio, Proxy Servers](#) for more information on proxy server properties.

To add a new proxy server, either select the proxy server category and click **Add Proxy Server**, or right-click the proxy server category and click **Add**. You can import proxy servers from legacy properties files by selecting the proxy servers category and clicking **Import Proxy Servers From File**. This opens a

window in which you can paste the contents of the file to import. The file must have the format described at the bottom of the [Proxy Servers](#) topic.

1. On the Cluster Settings window, Proxy Servers, select **Add Proxy Server**.
Optionally, you can right-click the proxy server category and click **Add**.

Note To import proxy servers from legacy properties files, select the proxy server category and click **Import proxy servers from legacy property files**.

A window appears in which you can paste the contents of the file to import.

2. Complete the following Proxy Server details.

- Host name
- Port number
- User name
- Password
- Excluded host names

3. Click **OK**.

Cluster Logs

You can enable or disable logging options for the cluster RoboServers.

Database Logging

If database logging is enabled, the RoboServers will log to the [RoboServer Log Database](#) defined in the Design Studio settings. If Log Robot Input To Database is selected, the robot inputs are logged to the database.

Note A RoboServer log database **MUST** be configured and enabled for database logging to work. If no database has been configured, the cluster settings will be invalid (you will be informed of this, so you can correct the problem).

log4J

Using log4j you can control where the log goes using an ordinary log4j.properties file. The log4j.properties file is located in the Configuration directory of the Kapow Application Data Folder, for example, `C:\Users\name.lastname\AppData\Local\Kapow\10.0.0\Configuration`. See the *Kofax Kapow Installation Guide* for more information.

The default log4j.properties file logs all robot run information, robot messages and server messages into a file. The logs are placed in the Logs folder in the application data folder. More advanced setups include storing in the Windows event log, rotating files, and the syslog. See the log4j manual for details.

When enabling this log, RoboServer will log using three different loggers.

Logger	Description
log4j.logger.kapow.servermessagelog	Used for server logging that is not tied to a particular robot run.
log4j.logger.kapow.robotrunlog	Used to log information about starting and stopping robots, including the execution time.

Logger	Description
log4j.logger.kapow.robotmessagelog	Used to log robot messages, such as information related to error handling. Also includes profiling, if it is set up to be output to the log.

E-mail Logging

This will send an e-mail whenever a robot logs an error message or the server has an error message.

Property	Description
To Address	Who should receive the e-mail. You can add multiple addresses separated by ",".
From Address	The from address to be used on the e-mails.

Profiling

If you enable profiling of robots you can see the execution time for the individual steps and the entire robot. This is very useful if you have a slow running robot and want to improve performance.

Profiling is configured using the following properties.

Property	Description
Output Type	If you choose Summary, only one statement summarizing the execution is written to the profiling log for each robot execution. If you choose Detailed, a detailed statement is written to the profiling log for every step executed in a robot, provided the execution time of the step is above the threshold defined by the Threshold property.
Output Target	This controls where the profiling information is sent: to the console, a file, or the log.
Threshold	This threshold defines the smallest execution time (in milliseconds) for a step to warrant inclusion in profiling information.
Log page URL in wait messages	If checked, the page URL is printed before the page load wait time.

Robot Execution

Use this section to define properties for RoboServer robot execution. Specify how many robots can run concurrently on the (individual) RoboServers, and how many can be queued. See "Product Configuration" in the "Runtime" section of the Kapow Administrator's Guide for help on assigning the proper values.

Property	Description
Max concurrent robots	Maximum number of robots allowed to execute concurrently on each RoboServer.
Max queued robots	Maximum number of robots allowed to reside in the queue on each RoboServer.

Devices

This tab shows available Automation Devices that are registered with the Management Console. To register an Automation Device in the Management Console, specify the Management Console's details and set the "singleUser" option to `false` in the Automation Device Agent configuration file. For more information, see [Automation Device Mapping](#).

The following information is displayed for each device.

Column	Description
Cluster/Device	<p>For Clusters The name of the cluster.</p> <p>For Devices Either IP address or name of the Automation Device and a port used to connect to the device.</p>
Status	<p>Current status of the device. The status can be as follows.</p> <ul style="list-style-type: none"> ▪ Available: The Automation Device Agent is running and no one is connected to the device. ▪ In Use: The Automation Device Agent is running and either a Design Studio or a RoboServer is connected to the device. Note that only one connection can be established with the automation device. ▪ Offline: Either the remote device is off or the Automation Device Agent is not started.
Label	Label of the device mapping. You can use the labels to filter the devices you want to automate with your robot.

Projects

Use the Projects section of the Admin tab to configure which projects are available in the Management Console.

Projects are a way to segment robots, types, snippets, resources and schedules. Robots only have access to the type, snippets and resources contained in the project they belong to. Names of robots, types, etc. also need only be distinct within a project.

Note that if you delete a project, all of the robots, types, snippets, resources, and schedules associated with it are deleted as well.

By default, the Management Console contains a single project.

When deploying the Management Console on a standalone web container, you can also configure project permissions for users based on their group membership (for instance LDAP groups). For details, see the "Tomcat Management Console" section of "Project Permissions" in the *Kapow Administrator's Guide*.

The project name is used as a foreign key in the log tables to determine who has permission to view the log files. This means that when you rename a project, all existing Robot Runs and Robot Messages belonging to this project must be updated to reflect the new name. Otherwise they will not show up when

the logs are filtered by project. If the Management Console is connected to the logging database when you rename a project, the Management Console will automatically rename the Robot Run/Message entries in the log database. However if it is not connected, or the connection is lost during the update, the administrator must manually run the following SQL to update the log tables.

```
UPDATE ROBOT_RUN SET projectName = '<newName>' where projectName = '<oldName>';
UPDATE ROBOT_MESSAGE SET projectName = '<newName>' where projectName = '<oldName>';
```

Where `<oldName>` is the old project name, and `<newName>` is the new project name.

Rest and SOAP Services

Robots can be exposed as Rest or SOAP services. If you open the Services tab of the "Edit project" dialog box, you can configure the runtime for these services.

Edit Default project

Basic | Permissions | **Services**

Robots can be invoked as RESTful services. Here you select the cluster used to execute robots for this project. When REST services are invoked directly from a browser (using XMLHttpRequest) you must disable authentication and fill in Access-Control-Allow-Origin. Access-Control-Allow-Origin controls which domains may call the service, you may use * to allow all. When authentication is disabled, anyone with access to the application can invoke these services, so be careful when selecting which robots to put into this project.

Service Cluster: Production

Authenticate REST/SOAP requests:

Access-Control-Allow Origin:

Save Cancel

By default, Rest/SOAP services are protected by basic authentication. When invoking the services directly from a browser (using XMLHttpRequest), you have to disable the authentication, as you would otherwise be exposing login credentials in the JavaScript source files. When calling Rest/SOAP services from a programming language like Java, Ruby, C#, etc, it is a good idea to have the services protected by authentication (assuming that you can keep the credentials stored in a secure manner).

There are certain restrictions when calling a Rest/SOAP service from a browser, unless the service is located on the same web server as the web page from which it is invoked. When calling a Rest/SOAP service from another domain (referred to as CORS Cross-Origin Resource Sharing), you have to include certain headers for the client to be allowed to process a resource from another domain. The Access-

Control-Allow Origin is one such header. If you call a Rest/SOAP service in a cross-domain fashion, you must specify the domain, from which the page that generated the request was loaded. If a page on <http://example.com> contains a page with JavaScript that generates a request to a service located on <http://kapowsoftware.com>, then the service response from <http://kapowsoftware.com> must contain the header `Access-Control-Allow-Origin: http://example.com` or built-in security mechanisms in the browser will prevent it from processing the cross-origin response. You may use `*` as a wildcard, which means that any domain can invoke your Rest/SOAP service in a cross-domain fashion.

Manage Users and Groups

Use this tab to manage users and groups that can be granted access to the Management Console and projects. The security model is role-based; that is after you create a user, you must add him or her to one or more groups, which are associated with specific roles in one or more projects. It is a good idea to create groups first, because a user will not be able to login, until he or she is added to a group that is granted a view role inside at least one project.

The Users tab helps you create new users and edit, remove, and reset passwords for selected users. To manage groups, click Groups. To go back to the Users tab, click Users.

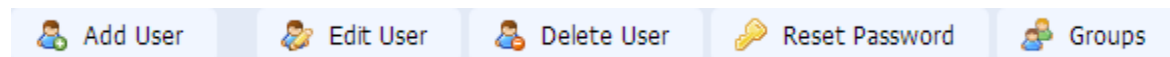

The Groups tab helps you create, remove, and edit groups.

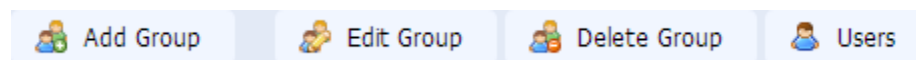

The following information can help you understand some Kapow user management principles.

There are two ways to run the Management Console: embedded in a RoboServer with any license and on a standalone Tomcat server (requires enterprise license). For information about Management Console on Tomcat, see "Tomcat Management Console" in *Kapow Administrator's Guide*.

When the Management Console runs in embedded mode, there are two types of user management, single user or multi user. This is configured using the RoboServer Settings (RoboServerSettings.exe) application located in the `/bin` subfolder of the Kapow installation folder.

To enable multi user mode, do the following:

1. In the Kapow installation folder, `/bin` subfolder, double-click **RoboServerSettings.exe** to run the RoboServer Settings application.
2. On the Management Console tab, select **Enable User Management**.
You can also specify an administrator name and password.
3. On the General tab, select **Register to a Management Console** and specify the URL, name, password and cluster name for the Management Console where you want to enable multi user mode.
4. Restart the Management Console for the changes to take effect.

Depending on your license and the way you run the Management Console, you can manage user access as follows:

- Single user - only available in Embedded mode
- Internal user management - available in both Embedded and Standalone mode
- External user management (LDAP or CA SiteMinder) - only available in Standalone mode with enterprise license

Note When you run the Enterprise version on a Tomcat server, Management Console is always in the multi-user mode and you can choose to manage your users either in the Management Console (like in the embedded mode) or get the user credentials from your corporate LDAP server.

Settings

Use this tab to configure the Management Console. Click **Save** for the changes to take effect. Additional options, which affect how you connect to the Management Console (such as port numbers and security settings) are configured in the Settings application as described in the Embedded Management Console Configuration topic of the *Kapow Administrator's Guide*.

RoboServer Authentication

In this section, you configure the credentials (user name and password) that the Management Console will use when running robots on the RoboServers belonging to the configured clusters. The Management Console will use the same set of credentials for all RoboServers. These credentials must match the configuration as described in the Requiring Authentication section of the *Kapow Administrator's Guide* for all the configured RoboServers.

RoboServer Log Database

This is the logging database used by the Management Console to store Schedule Runs and Schedule Messages as well as all RoboServers belonging to clusters where database logging has been enabled in the [cluster settings](#). The database is configured in the same way as the [cluster databases](#).

The following cleanup thresholds can be configured for the RoboServer log database.

Property	Description
Keep robot and schedule statistics for (day)	Specify the number of days to keep the robot and schedule statistics. According to the cleanup settings you define, the old data is deleted on a daily basis.
Max messages in robot run	Specifies the maximum number of messages in the robot run. The log automatically cleans up the database when the number of robot messages in the database exceeds this threshold. The cleanup deletes the oldest robot runs and the messages for the deleted runs. If you experience performance problems with the log database, you can lower this threshold. To store more historic messages, you can increase this threshold.

To use a database for logging, you must prepare your database server by either creating a new database (schema), or simply making sure an existing database is available. You must obtain a username and password with rights to create tables, drop tables, create indexes, drop indexes, select, insert, update, and delete in the database.

Both the Management Console and RoboServer will create the log tables automatically when they are started (if the tables do not already exist). However, you may also create them using the [Scripts for Creating Database Tables](#).

Scripts for Creating Database Tables

The SQL scripts for creating and dropping tables in your database are located in the `documentation\sql` directory in your Kapow installation directory. For example, `C:\Program Files (x86)\Kapow 10.0.0 x32\documentation\sql` on the Windows system. The name of the script file includes the name of the database the script is intended for.

Note SQL scripts are installed together with Kapow documentation and if you install Design Studio.

SQL Scripts for Database Tables

The `sql` directory contains four subdirectories with different scripts as follows:

- `altosoftsession`: Scripts for creating and dropping tables for single sign on with Altosoft
- `logdb`: Scripts for creating and dropping logdb tables
- `mc`: Scripts for creating and dropping Management Console tables
- `statistics`: Scripts for creating and dropping Statistics (KAFKA) tables

Important The IBM DB2 database must have a table space with a page size of at least 8192 KB to create all tables.

The Management Console uses a 3rd party scheduling component called Quartz. Quartz also requires a number of tables which must reside among the other platform tables. These tables are also created automatically when the Management Console starts, or may be created manually using the scripts.

The following is a Quartz verification script.

```
select count(*) from QRTZ_SIMPLE_TRIGGERS;
select count(*) from QRTZ_BLOB_TRIGGERS;
select count(*) from QRTZ_CRON_TRIGGERS;
select count(*) from QRTZ_TRIGGER_LISTENERS;
select count(*) from QRTZ_CALENDARS;
select count(*) from QRTZ_FIRED_TRIGGERS;
select count(*) from QRTZ_LOCKS;
select count(*) from QRTZ_PAUSED_TRIGGER_GRPS;
select count(*) from QRTZ_SCHEDULER_STATE;
select count(*) from QRTZ_JOB_LISTENERS;
select count(*) from QRTZ_TRIGGERS;
select count(*) from QRTZ_JOB_DETAILS;
```

Analytics Database

This tab helps you to set up your connection to the database used by the Kofax Insight dashboards. The database is configured similarly to the [RoboServer Log Database](#).

The following cleanup threshold can be configured for the Analytics database.

Property	Description
Keep RoboServer statistics for (day)	Specify the number of days to keep the statistics for. According to the cleanup settings you define, the old data is deleted on a daily basis.

You must prepare your database server by either creating a new database (schema), or simply making sure an existing database is available. You must obtain a username and password with rights to create tables, drop tables, create indexes, drop indexes, select, insert, update, and delete in the database. For more information, see [RoboServer Log Database](#).

If you plan to using HTTP request authentication in Kofax Insight, create a [single sign-on](#) database.

Note The availability of the Analytics functionality depends on the license. If you have a license for Analytics, the Analytics Database configuration panel is present on the **Admin > Settings** tab in the Management Console.

SMTP Server

This section allows you to configure a mail server used for sending notifications to Kapplet users (if notification is selected when starting the Kapplet), and for sending e-mail log messages if e-mail logging has been enabled in the [cluster databases](#).

NOTE: for Kapplet notification e-mails to work, a from address must also be specified under [Kapplet Result](#).

The SMTP server is configured using the following properties.

Property	Description
Host	The SMTP server host name.
Port	The SMTP server port.
User	If the SMTP server requires authentication then enter the user name here.
Password	If the SMTP server requires authentication then enter the password here.
Encryption	<ul style="list-style-type: none"> ▪ NONE: Credentials and email are sent in clear text. ▪ TLS: TLS encryption is used. This only works if the SMTP server has a trusted certificate (if the server has a self-signed certificate it must be exported and imported into the JVM's truststore using the keytool utility). Uses the STARTTLS SMTP extension. ▪ SMTPS: SMTP over SSL. A secure channel of communication is established, over which the Credentials a email is sent. This is rarely supported by SMTP servers, but will work even if the server uses a self-signed certificate.

Base URL

The application base URL is used to generate results links in Kapplets, so that the e-mails contain results residing on the Management Console server.

Note Typically, the base URL is configured automatically, and it is not necessary to change it.

Proxy Server

This section allows you to specify the proxy server through which the Management Console connects to external servers, for instance when generating OAuth security tokens for accessing external APIs.

The proxy server is configured using the following properties.

Property	Description
Use Proxy Server	True if a proxy server should be used, false to use a direct connection.
Host	The proxy server host name.
Port	The proxy server port.
User	If the proxy server requires authentication, enter the user name here.
Password	If the proxy server requires authentication, enter the password here.

Kofax Insight Dashboards

You can enable Kofax Insight dashboards in Kapplets and specify a server URL to connect to.

After you select Allow Dashboards and specify a URL in the Server URL, restart your Kapplets. The Main Navigation menu should contain the NEW DASHBOARD menu item.

To create a new Kapplet with a connection to the Kofax Insight dashboards, click **NEW DASHBOARD** and specify all necessary parameters.

You can also specify the [single sign-on parameters](#).

Single Sign-On

You can configure a database connection to a single sign-on (SSO) database that will be used for HTTP request authentication by the Kofax Insight dashboards. Create the SSO database beforehand just like other databases for use with Kofax Insight. All necessary tables are created by Kapow. For more information, see *Kofax Analytics for Kapow Administrator's Guide*.

Specify all parameters for the kapplet to connect to the database that is used by the Kofax Insight dashboards.

- Host: Specify a server name that runs the database used by the Kofax Insight dashboards.
- Schema: Specify a schema name.
- Database type: Select a database type from the list.
- User name: Type a user name to connect to the selected database.

- Password: Type a password to connect to the selected database.

Shared Databases

Shared databases are sent to all Design Studio clients being activated by (getting license from) the Management Console.

To simplify the user interface, these databases are configured on a cluster.

- To make databases available in a certain cluster and in Design Studio clients, select the cluster in the Shared Databases window and make sure a [database mapping](#) exists that points to this database. You can check database mappings on the **Repository > Databases** tab. Choose **All Clusters** to make databases from all clusters available in Design Studio clients.
- To define a special set of databases that are available for Design Studio, you can create a special cluster. This approach may be useful if you prefer not to send production databases to Design Studio.

The default cluster named Production is automatically created for shared databases.

Kapplet Result

Use this section to configure Kapplet results settings.

Property	Description
From address	Sets the e-mail address used to send results emails. Note that results e-mails also require a properly configured SMTP server .

Database Types

You can define the database type, such as MySQL. A database type consists of the following properties.

Property	Description
Name	The name identifying the database type.
JDBC driver	The JDBC driver class of the driver (the driver must be uploaded under Database Drivers).
Connection URL template	<p>A template string defining how connection URLs for databases of the given type look. Possible variables to use in the template string are the following:</p> <p>\${ServerName} Defines the server name (host) of the database server.</p> <p>\${Schema} Defines the schema (or database/catalog depending on database vendor) of the database.</p> <p>An example of a connection string template is 'jdbc:mysql://\${ServerName}/\${Schema}'. This string defines the connection string for a MySQL database running on the default port (no port is specified), on the server given by \${ServerName} and using the schema given by \${Schema}. The variables are given values when databases of the given type are created (see the cluster databases section).</p>

Property	Description
Validation query	The validation query for a database is the query to use when validating connections to the given database. Such queries vary greatly between different types of databases.

The database types are also sent to Design Studio clients.

To add a new database type, select the database type category, and click [Add Database Type](#). Alternatively, right-click the Database Type category and select [Add Database Type](#).

Note Kapow does not support adding new database types. However, you can modify the database types in order to add a type that defines a database server running on a non-standard port or requiring a [different authentication method](#).

Database Drivers

The Database Drivers section contain uploaded database JDBC drivers. These drivers are required by the various databases types. As with database types, uploaded database drivers are also sent to Design Studio clients. Note that if you run your Management Console on, for instance, a MySQL database, you need to provide Tomcat with the MySQL driver. This means that MySQL databases will work when used in the Management Console (on the Log tab or when testing the connection). However, for the MySQL databases to also work on all RoboServers, it is necessary to upload the MySQL driver here so that it can be sent to the RoboServers (and Design Studio).

Note The Derby JDBC driver is not distributed with the Enterprise Management Console. See [Apache Derby](#) Web site for Derby JDBC driver download information. We recommend using MySQL or another enterprise-class database with your Enterprise Management Console.

Hint

On certain database types, you may need to tweak parameters or settings to store files larger than a certain size. For instance, on MySQL databases, you may have to increase the value of the "max_allowed_packet" variable, which in many installations is set to 1 MB (meaning that database drivers larger than 1 MB cannot be stored). Please consult the documentation for your database if you encounter problems when uploading drivers. To help identify any problems, you will receive an error message, and the Management Console log will contain further details.

Security Note

By default, only the admin user is allowed to upload JDBC drivers while accessing the Management Console from the localhost. If you are running the Management Console in embedded mode, you can change this behavior in the RoboServer Settings application. Refer to the "Embedded Management Console Configuration" section in the *Kapow Administrator's Guide*, for further details. If you are running the Management Console in Tomcat, refer to the "Security" section under "Tomcat Management Console" in the *Kapow Administrator's Guide*.

Back Up Management Console

Use the Backup tab to copy all or part of the Management Console configuration into a file for backup or export purposes. If necessary, you can use the file to perform a restore or import operation.

Note You can restore backups created in Kapow version 9.2 or later. For earlier versions, contact Kapow technical support for assistance in migrating your data.

It is important to understand the difference between creating/restoring a backup and exporting/importing a project.

A backup contains all of the Management Console configuration including all schedules and all projects in the repository, and can be restored only in its entirety. It may be used to restore the system after data loss, or when upgrading to a later version of Kapow. In the latter case, you will create a backup of the old instance of the Management Console and restore it into the new instance. See [Restoring a Backup](#) for more information on restoring from an instance of the Management Console prior to release 8.1.

Note Prior to release 8.1, "Create Backup" was named "Export"; the term "export" is now used only for "Export Project."

Use **Export Project** to create a file with information pertaining to a single project. This comprises the schedules, robots, types, and resources within the project. Such a file may be used to copy schedules, robots, and so on, from one Kapow system to another, for example when moving from a test environment into production. It is possible to import into an existing project on the target system; in this case, items from the file are merged into the project, overriding present items when names match. It is also possible to do a selective import that includes only some items.

Creating a Backup

1. To create a backup, in **Admin > Backup**, click **Create Backup**.
The Create Backup window appears.
2. Click **Create Backup**.
3. When the backup is complete, select **Click to download**.
You can open the backup files, or click **Save**.

Exporting a Project

When exporting a project, you must select the desired project in this window. Then click **Create** to create the desired backup/export file; this may take a while. When the file is ready, a download link appears. The link is active only while the window is open; you cannot copy the link and use it after closing the window.

1. To export a project, in **Admin > Backup**, click **Export Project**.
The Create Export window appears.
2. Select the project to export.
3. Click **Create Export**.
4. When the export project is complete, select **Click to download**.
You can open the export files, or click **Save**.

Restoring a Backup

When restoring an export from a Management Console prior to release 8.1: As described above, it is possible to restore from a backup made with an earlier release of the Management Console. Three caveats should be kept in mind: First, the terminology was changed in release 8.1. Previously, the term

"export" was used for what is now named "backup". That is, if you want to migrate contents from a Management Console prior to release 8.1, you must use its "Export" function to create an export file. Secondly, this file must be converted to the new backup file format with the aid of the "Upgrade Pre-8.1 Management Console Export" feature in the Tools menu of Design Studio. Thirdly, the new project based permissions introduced in 8.2 mean that permissions from a previous version can not be upgraded automatically. After you restore an older backup, you have to assign project permissions manually.

Note Starting from Kapow 9.5.0, the threshold for cleanup has been changed from a number of records to a number of days; thus the number of days is set to 10 in case of old backup with a number of records 50000 or more (the old default). If the number of records is less, the number of days is scaled back accordingly.

1. To restore a backup, in **Admin > Backup**, click **Restore Backup**.
The Restore Backup window appears.
2. Browse to the backup file to restore.
3. Click **Restore**.
4. When the restore is complete, click **OK** and then click **Close**.

Importing a Project

1. To import a backup, in **Admin > Backup**, Click **Import Project**.
The Import Project window appears.
2. Select the items to import.
Available options include:
 - Import Schedules
 - Import Robots, Types and Snippets
 - Import Resources
 - Import OAuth
 - Import Master Kapplets
 - Import Permissions
3. Browse to the backup file to import.
4. Click **Import**.
5. When the import is complete, click **OK** and then click **Close**.

License

Use the License tab to enter a new license or view the current license. The Management Console has room for two license keys: A Production and a Non-Production key. If your production environment is completely separated from your development/QA environment, you need to install two Management Consoles: one contains the Production license key, while the other contains the Non-Production license key. In mixed environments, a single Management Console should contain both keys.

This tab also shows information on the Design Studio seats currently in use (Design Studio clients that have received a license from this Management Console and are currently active).

Note Some items in the list are shown only if you have appropriate license. For example, if you have a license for Analytics, the Kofax Analytics for Kapow: Yes item appears in the About the Current License table.

Add Database Type

This topic provides steps to add a modified database type in the Management Console. As an example, we will add a Microsoft SQL Server that requires Windows Integrated Security.

1. In the Management Console, go to **Admin > Settings** tab and click **Database Types**.
2. Click **Add Database Type**.
3. Specify the following values:
 - Name: Microsoft SQL Server (Integrated Security)
 - JDBC driver: com.microsoft.sqlserver.jdbc.SQLServerDriver
 - Connection URL template: jdbc:sqlserver://\${ServerName};databaseName=\${Schema};integratedSecurity=true
 - Validation query: SELECT 1

Click **Save** to add the database type to the list.

4. Download the "Microsoft JDBC Driver 4.0 for SQL Server" from the Microsoft web site, and extract it to a folder on your disk.
5. Copy `sqljdbc_auth.dll` to the `\lib\jdbc` directory in the Kapow installation folder. The file is located in the extracted folder under `Microsoft JDBC Driver 4.0 for SQL Server \sqljdbc_4.0\enu\auth\x64 or \86` folder.
If there are RoboServers running on other computers, the `sqljdbc_auth.dll` must be installed on each one.
6. Upload the `sqljdbc.jar` file to the Management Console. Select **Database Drivers** in the **Admin > Settings** tab and click **Upload Driver Jar**. Browse for the corresponding JDBC driver. The `.jar` file is located in the extracted folder under `Microsoft JDBC Driver 4.0 for SQL Server \sqljdbc_4.0\enu`.
7. Restart Kapow Management Console.

You can now connect to the database that uses the newly created database type on the **Admin > Clusters** tab of the Management Console.

Notes on Microsoft SQL Server for Windows Integrated Security

- If you do not copy the required database `.dll` file, use the 32-bit version of the `auth.dll` instead of the 64-bit, or if you do not restart the Management Console, you may get the following error message: "Error connecting to the database: This driver is not configured for integrated authentication."
- If the server is not part of the domain, you may get the following error: "Error connecting to the database: Login failed. The login is from an untrusted domain and cannot be used with Windows authentication."

See the following topics for more details about using databases in Kapow.

- [Database Types](#)
- [Database Drivers](#)
- [Shared Databases](#)

- [Interact with Databases](#)

JMX

The Management Console offers a small amount of information via the JMX protocol. The information exposed through JMX is experimental, and should not be considered a public API.

The Management Console exposes the following MBeans:

Name	Description
DistributionController	Information on executing schedules, and cluster configuration.
FileBackedDataExporter	Information on exports created from the Data View.
RobotLibraryGenerator	Allows you to control the internal caching of Robot Libraries within the Management Console.
TaskQueuePerformanceTracker	Allows you to profile the distributed Task queue between two clustered Management Console instances.

The MBeans are accessible via JConsole and Java VisualVM (+MBean plugin). Both are included in JDK 1.6+ or any other JMX client.

OAuth

OAuth is an open standard for authorization used with many popular APIs such as Twitter and Facebook. It provides a means for applications (and in the case of Kapow: Robots) to access data or perform actions on a user's behalf without having direct access to the user's login credentials. For instance, a robot can use Twitter's API to extract the most recent mentions of a user, such as @KapowSoftware, using access tokens provided by that user but without having explicit access to @KapowSoftware's Twitter password.

The Management Console is used to generate access tokens, which are stored securely in a key store. The access tokens can be passed on as input to robots in a schedule. As always, the robots that perform the actual API calls and handle the returned data are created in Design Studio.

Supported Service Providers

In OAuth terminology, a service provider is the provider of the web service. Kapow supports the following service providers. Documentation on the APIs of each service provider can be found on their respective websites.

- Dropbox
<https://www.dropbox.com/developers>
- Facebook
<https://developers.facebook.com>
- Google
<https://console.developers.google.com/apis/library>

- LinkedIn
<https://developer.linkedin.com>
- Salesforce
<https://developer.salesforce.com>
- Twitter
<https://dev.twitter.com>
- Yelp
<https://www.yelp.com/developers>

Add Applications

To access the API of a service provider, you must create an application with that service provider. Creating an application will provide you with a consumer key (also known as API key or application key) and a consumer secret (also known as API secret or application secret).

To create an application, log in to the developer community of the service provider, select **Create New Application**, or similar option, and fill out the required information. See [Supported Service Providers](#) for links to service providers documentation for developers. In this topic we take a look at how this is done at Twitter.

1. First, log into <https://apps.twitter.com> (creating a new account if necessary), and click **Create New App** in the top right corner.



2. Fill out the required information, such as the name and description of the application, and read through Twitter's terms of service before accepting.

One of the fields in the form is a **Callback URL**. This is the URL that Twitter will redirect a browser to after the user has accepted to let your application interact with the Twitter account on the user's behalf. This field must be set to the path `OAuthCallback` under the folder in which the Management Console is deployed. For instance, if running with an embedded Management Console, it runs at `http://localhost:50080/`. In this case, the callback URL would be specified to `http://localhost:50080/OAuthCallback`. However, beware that some service providers do not allow a callback URL containing `localhost`. Twitter is one of those providers, so we will use `http://127.0.0.1:50080/OAuthCallback` instead.

Callback URL:

Alternatively (and this is required by some service providers), you must specify the hostname or non-loopback IP address of the machine on which you are running the Management Console. Since this page is loaded by the browser of the authenticating user, this need not be a public hostname or IP address.

After creating the application, a summary of the application appears. You must copy some of these values into Management Console.

3. Open Management Console in a browser. Use the same IP address or hostname that was entered as callback URL.

In the example below, we point our browser to `http://127.0.0.1:50080/`.

4. Navigate to **Repository > OAuth** and click **New Application**.

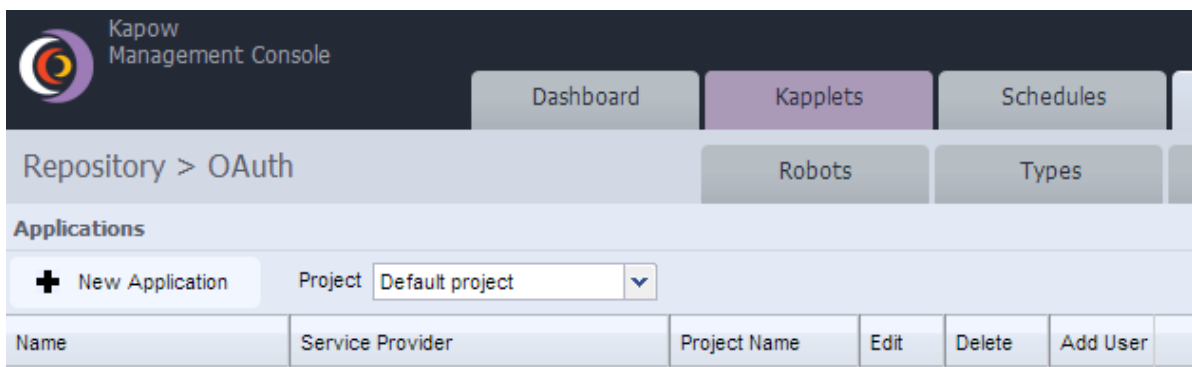



5. Select a name for the application (this does not need to be the same name as what is used when you created the application at the service provider) and select the service provider (in this case Twitter).

The consumer key and consumer secret must be copied from the summary page of the application presented by the service provider.

6. Enter the same callback URL you entered in step 3 and click **Save**.

Some service providers additionally require that you specify a scope; for example, what parts of the API that a user will authorize the application to access. For instance, when accessing Google, the scope `https://www.google.com/analytics/feeds/` must be specified if the application should be allowed to access the Google Analytics Data API. Twitter does not use the scope field, so this will be left blank in this example.

You have now set up an OAuth application in the Management Console.

Name	Service Provider	Edit	Delete	Add User
App1	Twitter			

Note If you edit the application later, the consumer secret is displayed as "(encrypted)" for security reasons. To change the consumer secret, simply replace this value in the input field with the new consumer secret; otherwise, leave as-is when editing an application.

Add Users

1. In the Add User column, click the **Add User** icon next to the application you created in [Adding Applications](#).

Name	Service Provider	Edit	Delete	Add User
App1	Twitter			 ←

The Add User wizard appears.

2. In the User Name field, enter a name for the user.
This does not need to map to the username used by the service provider. It is only used inside the Management Console.
3. Click **Next**.
4. Click the Authorization Link.

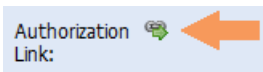

This opens the service provider's website. At Twitter, this looks as follows:

Authorize My Fantastic App to use your account?

This application **will be able to:**

- Read Tweets from your timeline.
- See who you follow.

[Forgot your password?](#)

5. Enter the username and password and click **Authorize app**.
The service provider now forwards you to the callback URL. If the authorization was successful, the Proceed with OAuth Authorization page appears.

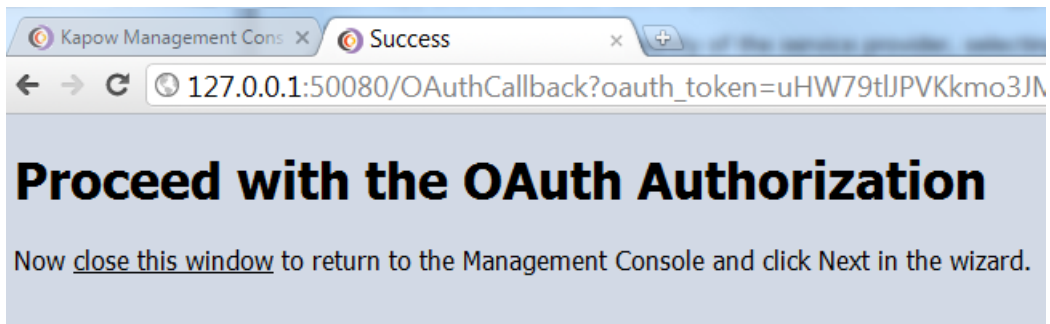

6. Close the browser tab and return to the Management Console.
7. In the wizard, click **Next**.

You will see the access tokens that can be used for accessing the service provider on the user's behalf. They have been securely stored in the Management Console's key store and can now be used as input to schedules.

Note You will need sample access tokens as test input for the robot that we will build in a later step. Copy the values into a text editor such as Notepad. For security reasons, you will not be able to retrieve them from the key store in unencrypted form after clicking Finish.

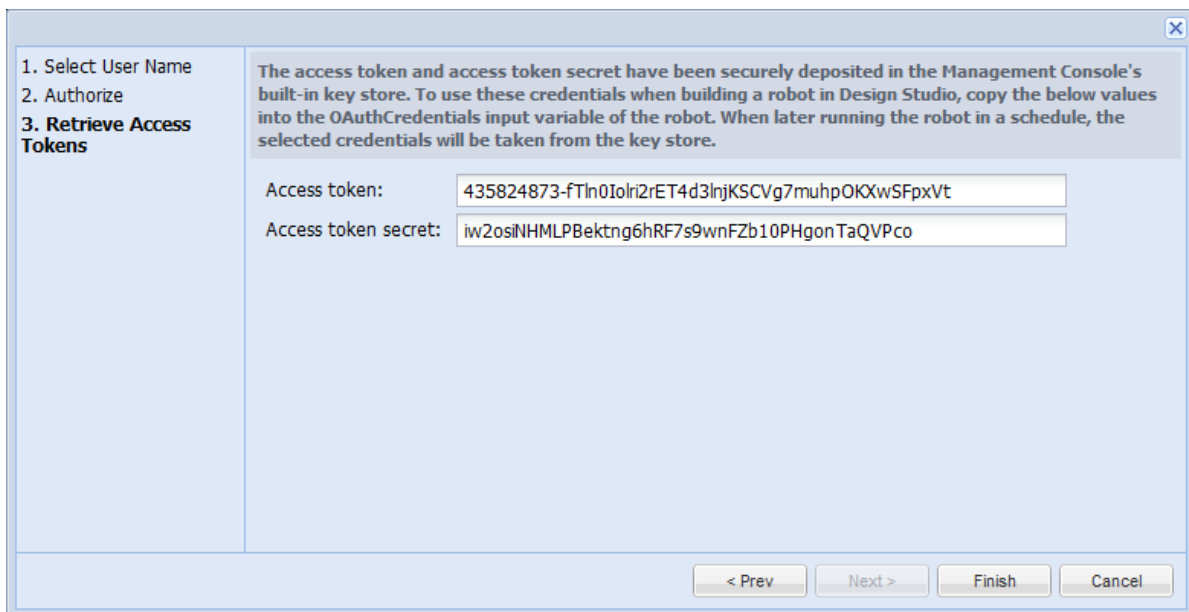

At Twitter, we get both an access token and an access token secret. Service providers that use OAuth 2.0 do not use an access token secret, so they will only return an access token. Some service providers will additionally return a refresh token. This is used when the access tokens returned by the service provider are only short-lived. Robots can then use the refresh token to obtain new access tokens without a user having to re-authorize through the Management Console. To create robots against the API of a service provider, you must copy all of the tokens displayed at the final step of the wizard.

8. Click Finish.

The User section appears on the OAuth tab.

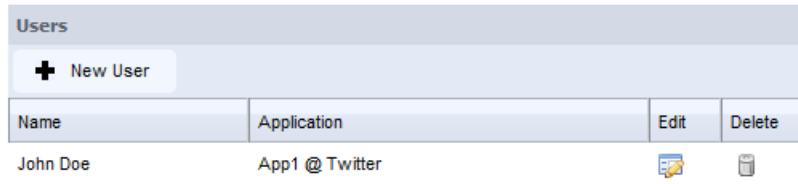

Users			
+ New User			
Name	Application	Edit	Delete
John Doe	App1 @ Twitter		

If you edit the user later, the access token, access token secret and refresh token are displayed as "(encrypted)" for security reasons. To change any of these, simply replace this value in the input field with the value; otherwise, leave as-is when editing a user.

Write Robots

In the following procedure, you will write a robot that accesses a REST API that uses OAuth as its authentication mechanism. As an example, you use the Twitter REST API to obtain the most recent statuses by the authenticating user and the users he or she follows.

1. Start Design Studio and create a new robot.
Do not enter a URL in the wizard. You will not be able to access the REST API before authentication.
2. Add a new input variable of type OAuthCredentials.
3. In the **serviceProvider** field, type **Twitter**.
4. Enter the access token and access token secret that was obtained when you went through the user authorization process in the Management Console wizard. Also enter the consumer key and consumer secret of the Twitter application.

DS Add Variable

Name:

Global:

Use as Input:

Type and Initial/Test Values:

• serviceProvider:

• accessToken:

accessTokenSecret:

refreshToken:

consumerKey:

consumerSecret:

5. Click **OK**.
6. Click **Configure Robot** .

The robot configuration window appears.
7. On the **Basic** tab, click **Configure**.
8. On the **All Loading** tab, locate **Credentials** and switch it from standard username/password authentication to **OAuth**.
9. Select the input variable you just added.

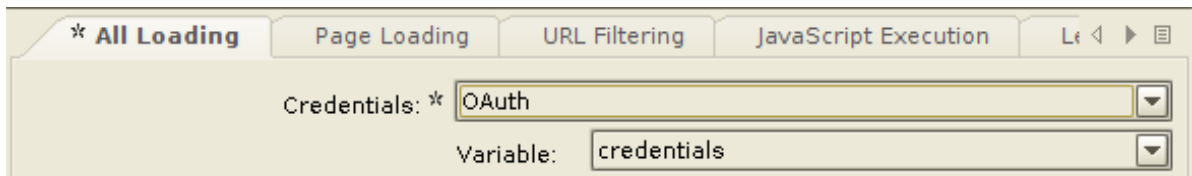

You should now see the XML that has been returned, containing the most recent statuses in the user's timeline, as above.

10. Click **OK** in both dialogs.

The robot is now configured to use OAuth and using the specified credentials when running in Design Studio. You can now start accessing Twitter's API. For instance, to see the most recent status updates by the authenticating user and the users he or she follows, you can access the URL http://api.twitter.com/1/statuses/home_timeline.xml.

11. Enter that URL in the address bar of Design Studio and press Enter.

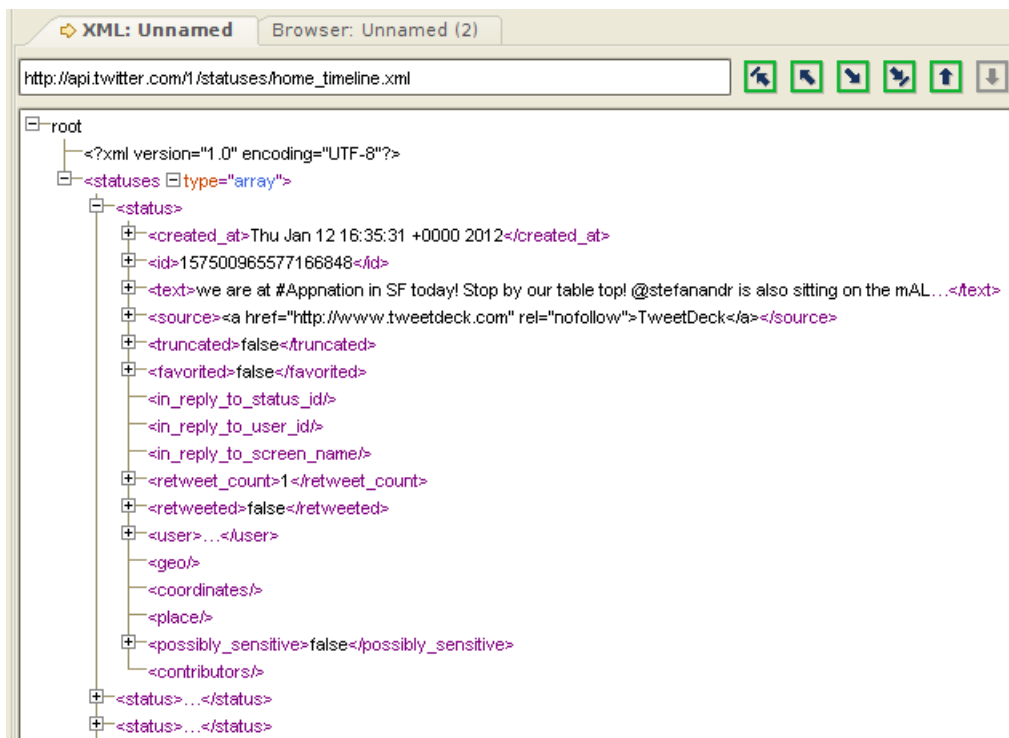

You should now see the XML that has been returned, containing the most recent statuses in the user's timeline.

Schedule Robots with Credentials

1. Save and upload the robot created in [Writing Robots](#).
2. Open the Management Console in a browser and create a new schedule.

3. To add the robot to the schedule, in the wizard click **Add robot**.
4. Click **Next** until you reach the **Configure input** step.

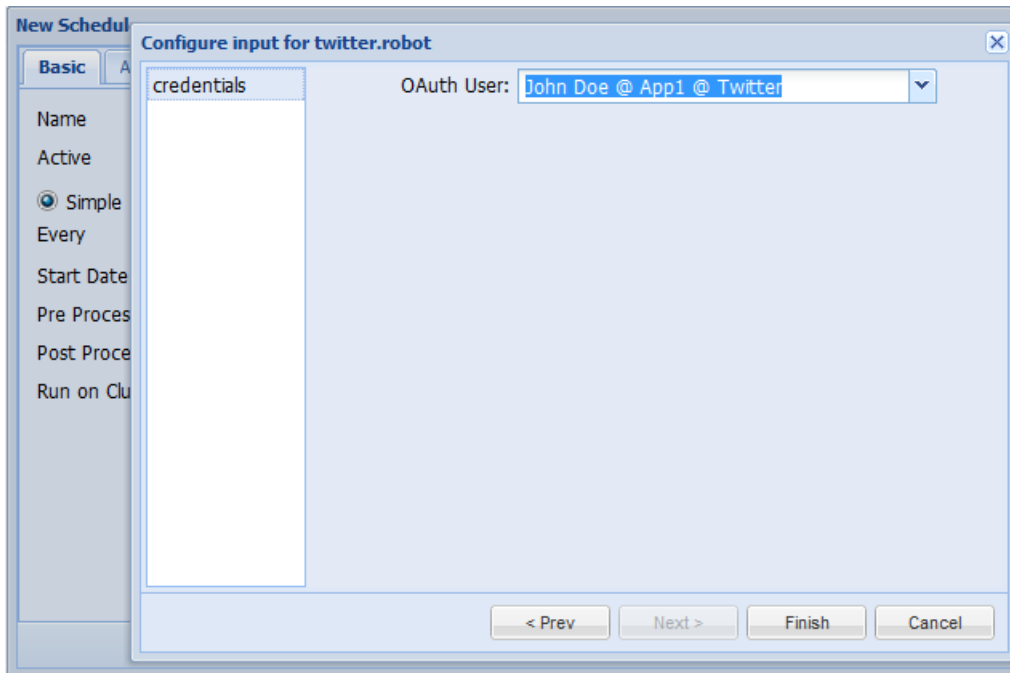

5. Select the OAuth user whose credentials you want to use when running the robot in this schedule. This auto-populates the service provider, access tokens, consumer key and consumer secret fields when the robot is run on RoboServer.
6. Click **Finish** and save the schedule. The robot is now ready to run.

Out of Band Applications

Some service providers also offer a mechanism to authorize OAuth applications without using a callback. This is known as out-of-band. Management Console also supports out-of-band authorization. The application created at your service provider must be registered as an out-of-band application; at Twitter this is done simply by leaving the callback URL field blank. Other service providers use the special value "oob" to signify an out-of-band application.

1. Leave the callback URL field blank or use **oob** based on service provider requirements.
2. When you register the application in Management Console, leave the callback URL field blank here. When adding users to the application, clicking the authorization link will not redirect back to the Management Console. Instead, the service provider will present a verifier or PIN.

You've granted access to Dev Null's Out Of Band Test App!

Next, return to Dev Null's Out Of Band Test App and enter this PIN to complete the authorization process:

3813110

3. In the Verifier field, enter the PIN provided by your service provider.

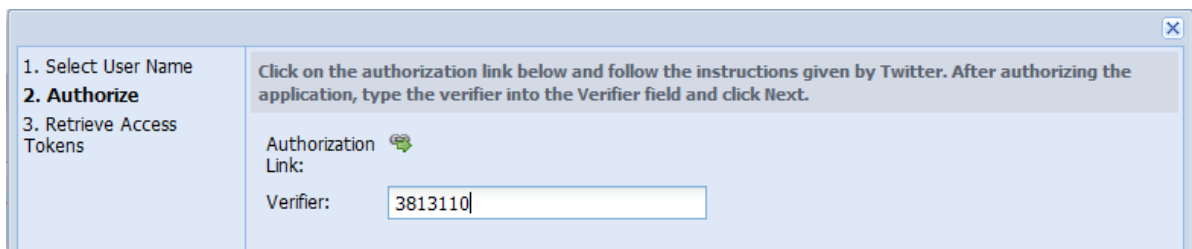

The screenshot shows a dialog box with a sidebar on the left and a main content area on the right. The sidebar contains a list of steps: 1. Select User Name, 2. **Authorize**, and 3. Retrieve Access Tokens. The main content area contains instructions: "Click on the authorization link below and follow the instructions given by Twitter. After authorizing the application, type the verifier into the Verifier field and click Next." Below the instructions, there is a label "Authorization Link:" with a small icon, and a label "Verifier:" followed by a text input field containing the PIN "3813110".

4. Click **Next**.

Chapter 6

Kapow Kapplets

Kapow Kapplets expose a friendly user interface to robots. A Kapplet Administrator can make execution of one or more robots available to users. These users do not need not know anything about robots as they will interact with the robots through the provided Kapplet. A Kapplet can be customized to match the terminology of the end-users; an icon and a description can also be attached.

A Kapplet is build and maintained by a Kapplet Administrator in the Kapplet Studio. When the Kapplet is ready for use it is made available for all Kapplet Users through the KappZone where the users can install the Kapplets into their individual My KappZone. Kapplet Users keep their own list of Installed Kapplets in My KappZone or bookmark Kapplets in their browser.

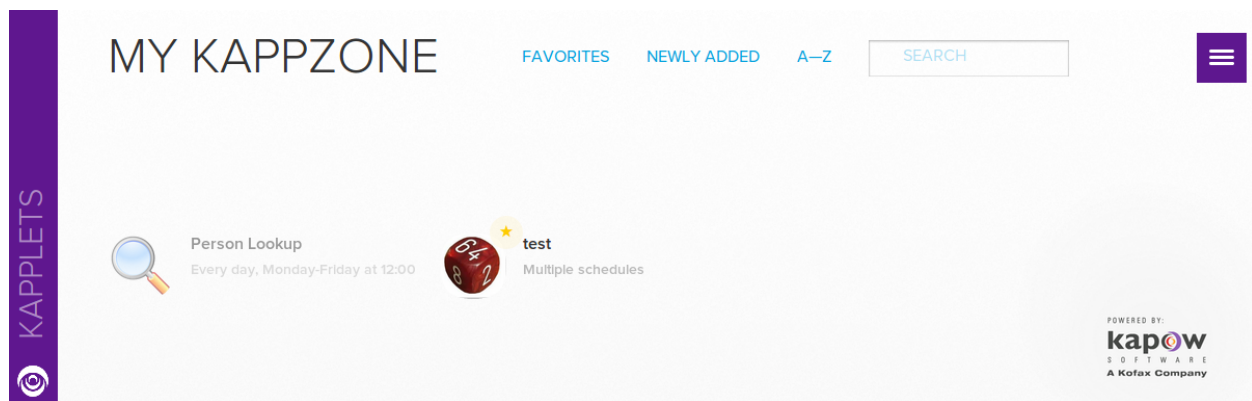

Kapplets build on the user/role management of the Management Console. With the Management Console deployed in a stand-alone application server, Kapplet Administrators use LDAP to manage which users have access to Kapplet-exposed robots in which projects.

Building and Maintaining Kapplets

The topics in this section provide information about [creating Kapplets](#) and [using the Kapplet Studio](#).

Creating Kapplets

1. In the Kapplet User area such as the KappZone, click **Add New Kapplet**. Alternatively, on the Main Navigation Menu, click **New Kapplet**. the Add New Kapplet window appears.
2. Enter a name for the Kapplet.

3. Associate the Kapplet with a project.

Using the Kapplet Studio

Use Kapplet Studio to enter general Kapplet information such as name, comment, and icon.

Note The Identity Section is only shown if no robots have been added to the Kapplet. If robots have been added, the Pages Section appears.

1. Open a newly created Kapplet to view the Identity Section.

2. In the Identify section enter a Kapplet name.
Enter additional information as required.

3. Click Pages.
The Pages Section appears.

4. Configure the Kapplet.

On the left hand side the present collection of Kapplet Page Definitions is enumerated in the form of clickable titled page icons. Each of these icons denotes a functional page/part of the Kapplet under construction. Some pages are mandatory for all functional Kapplets while others depend on the actual functionality.

Note The Start Page and the Result History Page are mandatory. These pages govern how input is collected for the Start Action and how the result history is shown, respectively.

1. Configure the **Start Page**.
2. Configure the **Results History Page**.
3. Configure the remaining pages as required.
The remaining pages govern how the results produced by the Start Action is presented and interacted with.
5. At the top of the Kapplet Studio, click **Apply Changes**.

The screenshot shows the 'EDIT KAPPLET' interface. At the top, there are tabs for 'IDENTITY' and 'PAGES', with 'PAGES' selected. To the right, there is an 'APPLY CHANGES' button and a toggle switch labeled 'Not published'. The main content area is titled 'START PAGE' and contains a 'START DIALOGUE' section with an 'EDIT' button. Below this is a text input field labeled 'TEST' and a 'START KAPPLET' button. A sidebar on the left contains buttons for 'START PAGE', 'RESULT HISTORY', 'OUTPUT TYPE 1', 'OUTPUT TYPE 2', and 'ADD PAGE'. A note on the right states: 'Edit the start dialog to add or remove the robots to be executed when the start button ("Start Kapplet") is pressed.' The bottom right corner features the 'kapow SOFTWARE A Kofax Company' logo.

Important You must apply changes, otherwise the changes will be lost.

Configuring the Start Page

1. Open the Pages Section.
The contents of this page depends on the robots associated to the Start Action. When no robots are associated, the page is empty. A robot can be added simply by clicking the 'Add Robots' area.
2. To add a robot, click **Add Robots** area.
the Add Start Action page appears.
3. Use Add Start Robots to select a robot for the Action.
4. Click **Add New Robot**.
The selection page lists your available robots.
5. To select a robot click a robot icon and then click **Select Robot**.
A list the attributes of the input variables defined by the added robots appears. For each attribute the Kapplet Administrator can then decide whether a fixed value should be associated (and the field then hidden from the user) or it should give rise to an input field. For example, an added 'test' robot expects a single variable 'input' with two attributes - one of which is user input and the other is fixed.

Note When you point to a robot name, you can see the path of the robot file.

6. Click **OK**.
the Kapplet Administrator returns to the Pages Section where the Start Page now shows an outline of the page that will be presented to Kapplet Users when they run the Kapplet.
7. The Kapplet Administrator can also change the user experience by interacting with the outline, such as the page title, the order and labels of fields, and the start button label.

Note The Pages Section also lists output types (if any) on the left hand side.

Using OAuth in Kapplets

If a robot that you add to a Kapplet contains an OAuth input for connecting to a service provider, the Edit Kapplet screen contains the Configure OAuth Credentials section.

1. To connect to a service provider, select **Configure OAuth Credentials**.
2. Select an Application from the list.
The application start page appears.
3. Click **Connect**.
The authorization process will be initiated asking the user to grant access. Having completed that flow, the Connect button disappears.
To see the authorizations stored for the user, you can use **Settings** in the main menu.

Connecting to Kofax Insight Dashboards

Kofax Insight gives organizations the ability to rapidly assemble, analyze and visualize immense amounts of complex data to improve decision making, operational effectiveness and profitability. Kapow Kapplets provide means to connect to Kofax Insight Dashboards using single sign-on mechanism. Use the following steps to create a dashboard kapplet.

1. In Kapow Management Console select **Admin > Settings > Kofax Insight Dashboards**.
2. Click **Allow Dashboards**.
3. Specify a **Server URL** of the server hosting an Insight dashboard.
4. To configure single sign-on parameters, select **Admin > Settings > Single Sign-On** and specify necessary parameters to connect to the database used by the Kofax Insight.
5. In Kapow Management Console go to Kapplets and open the KappZone.

Note If KappZone is already open, restart your KappZone.

6. On Main menu and click **New Dashboard**.
The **Add New Dashboard** window appears.
7. Specify parameters to connect to Kofax Insight.
 1. Specify a name in the **DASHBOARD NAME**. This is a display name for your Kapplet.

2. In the **Project** list, select a Kapow project you want to get statistics on.
3. Leave other fields empty.

Note If nothing is specified, the Kofax Insight uses its default parameters, or the default parameters for the user if single sign-on is enabled.

8. Click **Create Dashboard**.

Configuring the Result History Page

Every Kapplet has a Result History Page allowing Kapplet Users to access the results of past and present Kapplet runs. This page shows the results as list of items, each corresponding to a particular past run and consisting of a timestamp and an enumeration of the input parameters given to the start action of the run in question.

In the Kapplet Studio an outline of the Result History Page can be previewed and some aspects can be customized - however only the page title as of yet. As shown below the 'test' example robot gives rise to a list of elements consisting of a timestamp (not shown) and a single input value corresponding to the 'iterations' parameter.

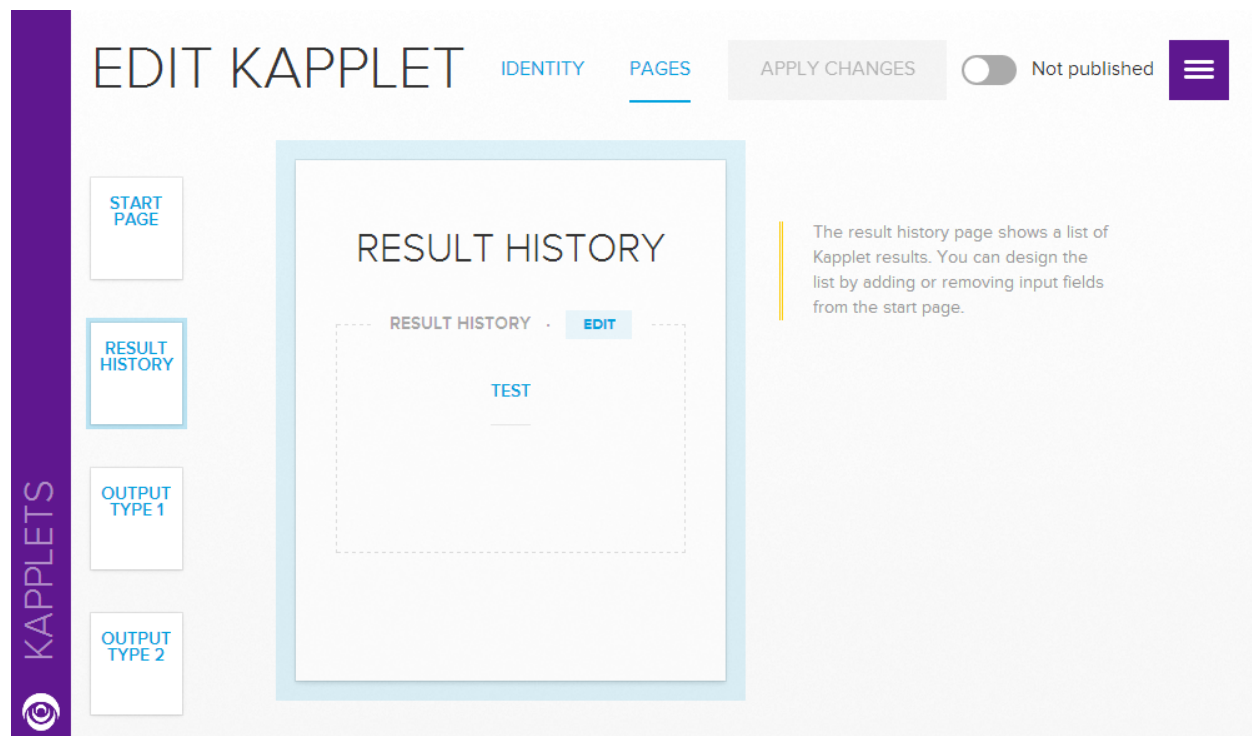

Adding a Commit Action

Once a Result Page is set up to show a tabular view of a dataset produced by the Start Action, the Commit Action can be added to the Kapplet. This window allows you to select a robot to facilitate a

commit of selected table rows into, a database, a web-service, or an actual website. The robot must take as input data of the same type as presented in the selection table, and must return the result of the commit in the form of a single object of a type different from the input type.

Returned types will change the actual selection table, such that the returned information can be shown together with the original information once the Commit Action has finished.

1. In the Result Page Table section, click **Add Robots**.
The Add New Commit Action window appears.
2. Click **OK**.
Once the Commit Action has been added, the Kapplet is (again) correctly configured and can now be used to collect, select, and commit data.

Important To make the Kapplet available to Kapplet Users, the Kapplet Administrator must publish the Kapplet.

3. Select an appropriate toggle at the top of the window.

Installing and Using Kapplets

For Kapplet Users that are now Kapplet Administrators, Kapow Kapplets will typically be accessed directly from the web browser by adding KappZone to the Management Console URL. For instance, if the Management Console is deployed at <http://localhost:50080/>, Kapplets can be accessed directly at <http://localhost:50080/kappzone>.

Note Un-Installed Kapplets allow the user to install while Installed Kapplets allow the user to open (run).

Users have access to Kapplets in the KappZone tab. When the user installs a Kapplet an instance of the Kapplet is made available in the users My KappZone. Any given Kapplet can only be installed once by a particular Kapplet User. An Installed Kapplet can be run both from My KappZone (click it) and KappZone (click 'open').

Users can bookmark Installed Kapplets from My KappZone in their browser, and they can "star" Installed Kapplets to add them to their display of favorites. In this way the user can navigate smoothly to the most often used Kapplets.

To bookmark a Kapplet, identify the Kapplet URL shown in the browser. You can simply bookmark the current page.

Open the KappZone and click Favorites to show Installed Kapplets for the current user. o

Invoking Kapplets

To run an Installed Kapplet, simply click it - either in My KappZone or in My Favorites, and fill out all of the required fields and click the Start button. In the example below the 'test' Kapplet requires only the 'iterations' field to be filled.

When using a Kapplet, the Kapplet User generally sees a view like the one shown above, where all active Kapplet Pages are shown simultaneously in left-to-right order starting with the Start Page, the Result History Page, and then Result Pages if relevant. Note, that until the Kapplet has been started, or an active Kapplet Run has been selected from the Result History Page only the Start Page and the Result History Page are shown.

Once the Kapplet is started a corresponding new Kapplet Run will be listed on the Result History Page and the corresponding Result Pages will be displayed to the right of the Result History Page. The active (not yet deleted) Kapplet Runs are always stored and can be re-found in the Result History Page of the corresponding Installed Kapplet. The corresponding Result Pages can be opened by clicking the relevant Result History Page entry. The above example shows the results of the 'test' Kapplet configured in the prequel. Selections in the table can be committed resulting in the output shown below.

If the user wants to work further with a tabulated Kapplet result in a 3rd party program then the Kapplet result can be downloaded in the Excel format.

Creating Email Notifications from Kapplets

For long-running Kapplets, you may not want to sit around waiting for the result page to populate. You can enter an email address when starting a Kapplet Run and will receive an email when the result is ready.

Below is an Installed Kapplet where the SMTP server is configured and the Kapplet User's email address has been entered.

1. Enable **Send results by email**.

This option is only present if an SMTP server is configured in the Management Console and a 'from' address is configured for Kapplets.

2. In the **Send results by email** field, enter a valid email address.

3. Click **START KAPPLET**.

When the Start Action is complete, an email is sent to the email address.

Scheduling Kapplets

You can run Kapplets at a predefined interval, such as every day at noon or every Friday at 4.50 pm.

1. To schedule a Kapplet, in the Schedule run section, select a run option from the list and complete the appropriate schedule information.

Note, that the time specification will be interpreted, as is, in the time zone of the server running the Management Console. Also notice that the Start button changes to a Schedule button when the 'Schedule run' option is toggled.

Once the Kapplet is scheduled it will run periodically as specified by the Kapplet User. The schedules configured for an Installed Kapplet can be listed in the left-hand side of the screen by clicking the 'Show existing schedules' link. An example of this list is shown below.

When the Kapplet User lists the Installed Kapplets the schedule is shown on the Kapplet.

2. To delete a schedule, select the schedule and click the delete icon in the left-hand schedule list. Notice that scheduling and email notification can be combined for Kapplets.

Customizing Kapplet Branding

You can customize the branding of KappZone and My KappZone to comply with your corporate color scheme, as well as to replace the Kapow logo with your own.

1. In the Management Console, Branding, Kapplets, Branding section, select **Custom**.

Note A preview of the logo and color is shown on the right.

2. In Drop the logo here or click to upload, browse to the logo you want to use. You can also drag and drop the new logo to the area if this functionality is supported by your browser.

The new logo appears at the top of My KapZone and KapZone windows. A smaller version of the logo also appears on some subpages.

3. In the Brand Color area, specify the background color code.

4. In the Contrast section, select a contrast option.

This color is used for the My KapZone text, as well as some icons placed on top of the selected background color. It is recommended that you specify a light contrast color for dark backgrounds, or a dark contrast color if you specify a light background color.

Chapter 7

Reference

Contents

- [Design Studio](#)
- [RoboManager](#)
- [RoboServer](#)
- [Management Console](#)
- [Java API](#)
- [Environments](#)

Design Studio

Design Studio is the Kapow application for writing and debugging robots.

Design Studio is an integrated development environment (IDE) for robots. Design Studio is all you need for writing robots in an easy-to-understand visual programming language. To support you in the construction of robots, Design Studio provides powerful programming features, including interactive visual programming, full debugging capabilities, an overview of the program state, and easy access to context-sensitive online help.

For an in-depth description of the Design Studio, see [Design Studio](#).

Step Action

This topic provides an overview of the available step actions.

Standard

This category contains the most commonly used step actions.

Action	Description
Assign Variable	Assigns a value to a variable.
Create Page	Creates a new page.
Load Page	Loads a web page from a URL.
Return Value	Returns a value from the robot.
Store in Database	Stores a value in a database.
Test Value	Causes execution beyond the step to stop or continue depending on a boolean value.

Assign/Transform Variable

This category contains the most commonly used step actions.

Action	Description
Assign Variable	Assigns a value to a variable.
Convert Variables	Converts the values of one or more variables by running them through data converters and storing the results in the same or other variables.
Transform XML	Transforms XML using XSLT.

Browser Session

This category contains step actions for saving and restoring entire browser sessions, as well as for extracting and manipulating cookies and HTML 5 web storage.

Action	Description
Save Session	Saves a session in a variable for later restoration by another robot run.
Restore Session	Restores a session in a variable previously saved by another robot run.
Extract Cookie	Extracts the value of a cookie matching patterns for name, domain and path.
Create Cookie	Creates a cookie with the specified domain, path, name and (optionally) value.
Remove Cookie	Removes one or more cookies matching patterns for name, domain, path and value.
Extract Web Storage	Extracts data from the local and/or session storage. The data is stored in a variable in JSON format.
Load Web Storage	Loads data into the local and/or session storage. The data must be specified in JSON format.
Clear Web Storage	Clears data in the local and/or session storage.

Browser Windows

This category contains step actions for opening, selecting and closing browser windows.

Action	Description
New Window	Creates a new window.
Set Current Window	Selects another window as the current window, such as the window that subsequent steps will work on.
Close Window	Closes a window.

Call Web Service

This category contains step actions for calling REST and SOAP web services.

Action	Description
Call REST Web Service	Calls a REST web service and loads the result into the current window or stores it in a variable.

Action	Description
Call SOAP Web Service	Submits a SOAP XML request to a web service and returns a SOAP XML response.

Click/Move Mouse

This category contains step actions that mimic clicking or moving the mouse to and from elements in the browser view.

Action	Description
Click	Emulates a mouse click on the found tag.
Move Mouse To	Emulates a mouse move to the found tag.
Move Mouse From	Emulates a mouse move away from the found tag.
Scroll	Emulates scrolling a document or tag.
Scroll To	Emulates scrolling the found tag into view.

Database

This category contains step actions that can store, retrieve, query or delete items in databases.

Action	Description
Store in Database	Stores a value in a database.
Find in Database	Finds a value in a database.
Calculate Key	Calculates the key used to store the value of the selected variable.
Delete from Database	Deletes an value in a database.
Query Database	Submits an SQL query to a database, and loops through the results.
Execute SQL	Executes an SQL statement on a database.
Store in HBase Table	Stores a value in a HBase Table.

Enter Data in Form

This category contains step actions for entering data in web forms.

Action	Description
Enter Text	Enters a text into a text field in a form.
Enter Password	Enters a password into a password field in a form.
Press Key	Emulates pressing Enter in a form.
Select Option	Selects an option in a drop-down box or a list box in a form.
Select Multiple Options	Selects multiple options in a list box in a form. Note: This action can only be used for list boxes, not drop-down boxes.
Set Checkbox	Selects or clears a check box in a form.
Select Radio Button	Selects a radio button in a form.
Select File	Selects a file to upload in a file field of a form.

Extract

This category contains step actions for extracting data. Data may be extracted in text or HTML form from a web site, or from other formats such as PDF, CSV, Excel and Flash. It is also possible to extract images or specific data about the HTML or XML source such as attribute values or link URLs.

Action	Description
Extract	Extracts some text, runs it through a list of data converters, and stores the result in a variable.
Extract Cell	Extracts content from an Excel page, runs it through a list of data converters, and stores the result into a variable.
Extract Selected Option	Extracts the text or value of the selected option, runs it through a list of data converters, and stores the result in a variable.
Extract URL	Extracts a URL from the found tag and stores it in a variable.
Extract Image	Extracts an image and stores it in a variable or a file. It can optionally store the content type and file name of the image in other variables.
Extract Screenshot	Extracts an image from the current page and saves it in a variable.
Extract Target	Extracts data from a URL target and stores it in a variable or a file. It can optionally store the content type and file name of the loaded data in other variables.
Extract Tag Attribute	Extracts a tag attribute from the found tag, runs it through a list of data converters, and stores it in a variable.
Extract Form Parameter	Extracts a form parameter from a form URL in the found tag.
Extract from Flash	Extracts content from a Flash object.
Extract from PDF	Extracts text from a PDF document contained in a variable.
Extract Binary Content	Extracts binary content from the current window.

File System

This category contains step actions for accessing the file system. You may read, write and modify files and directories, loop over files in a directory, or test for the existence of a given file.

Action	Description
Load File	Loads data from a file, either into the browser window or to a variable.
For Each File	Loops through the files in a directory.
Write File	Writes a new file or appends to an existing file.
Test File Existence	Causes execution beyond the step to stop or continue depending on whether a specific file exists.
Get File Info	Fetches metadata about a file in the file system.
Copy File	Copies a file on the local file system where the robot is executed. The action generates an error if the destination file exists.
Delete File	Deletes the specified file or directory.
Make Directory	Creates a new directory.
Rename File	Renames a file or directory on the local file system where the robot is executed. The action generates an error if the destination (New Name) exists.

Loop

This category contains step actions for looping. You may loop through HTML structures, windows, comma-separated values, form values, Excel ranges, or crawl entire domains. For looping through HTML structures, you have two options: For Each Tag and For Each Tag Path. The For Each Tag step action is the simpler of the two; it is used to loop through the immediate children of the found tag, while the For Each Tag path can loop through similar tags at any depth within the found tag. To loop through a number of pages connected by Next links or the like, you must use the Repeat and Next step actions.

Action	Description
For Each Tag	Loops through tags contained immediately inside the found tag.
For Each Tag Path	Loops through tags contained at any level inside the found tag.
For Each URL	Loops through the URLs contained in the found tag.
For Each Window	Iterates through the browser windows, setting each in turn as the current window.
For Each Text Part	Splits a text at a specified delimiter and loops through the parts.
For Each Option	Loops through the options in a drop-down box or list box in a form, selecting one option in each iteration.
For Each Radio Button	Loops through a group of radio buttons, selecting one of the radio buttons in each iteration. The found tag must be one of the radio buttons in the group.
Loop Field Values	Loops through the specified values, entering one value in the text field in each iteration.
Loop in Excel	Loops over the rows, columns, cells in the found range or over all the sheets in the Excel page.
Repeat	Creates a repeat loop together with the Next action.
Next	Requests another iteration in a repeat loop created using the Repeat action.
Crawl Pages	Crawls pages, each iteration outputting the next crawled page.
Get Iteration	Gets the current iteration of an enclosing loop step.

Load Page

This category contains step actions for loading pages from a given URL or creating a new page based on already extracted content. If required, you can also specify the page load request at the basic HTTP level.

Action	Description
Load Page	Loads a web page from a URL.
Create Page	Creates a new page.
Raw HTTP	Performs a Raw HTTP request of the selected method.

Make Snapshot

This category contains step actions for saving offline snapshots of web pages. To save an offline HTML copy of a page and its resources, use Make Snapshot. To save multiple interlinked HTML pages, use Rewrite Page and Rewrite Style Sheet.

Action	Description
Make Snapshot	Creates a snapshot of the current window, including its frames and resources.

Action	Description
Rewrite Page	Extracts the HTML content of the current window and additionally rewrites and outputs the links to style sheets, images and other pages.
Rewrite Style Sheet	Acts as a helper for Rewrite Page. Its task is to rewrite links to other style sheets or images in a given style sheet.

Modify Page

This category contains step actions for modifying the current web page, e.g. by removing, replacing or inserting content.

Action	Description
Insert Tag	Inserts a new tag.
Replace Tag	Replaces the found tag with a new tag.
Remove Tags	Removes tags from found tags. The Remove rules are executed in the order listed below. Any tags matching one or more of the Except rules are not removed. Defining no Remove rules defaults to removing all tags.
Remove Tag Range	Removes a range of tags.
Hide Tag	Hides the found tag.
Unhide Tag	Unhides the found tag.
Divide Text	Divides the text in the found tag into pieces.
Divide Table	Divides the input <table>-tag into several sub <table>-tags, one of which is output in each iteration.
Remove Table Rows	Removes from the input <table>-tag all rows (<tr>-tags) that do not have a specified number of columns (<td>- and <th>-tags).
Transpose Table	Transposes (flips) the input <table>-tag by mirroring its <td>-tags along the top-left to bottom-right diagonal.
Normalize Table	Normalizes a table by inserting extra cells to eliminate rowspan and colspan. The content from the original cell is copied to the new cells.

Other

This category contains various other step actions.

Action	Description
Set Named Tag	Marks the found tag as a named tag, so it can be used as a reference when finding tags in subsequent steps.
Set Named Range	Marks the found range as a named range, so that it can be used as a reference when finding ranges in subsequent steps.
Clear Named Tags/Ranges	Unmarks a selected named tag or range, or all named tags/ranges, so they are no longer be named in the subsequent steps.
Do Nothing	Does nothing.
Wait	Waits for a specified period of time.
Stop	Causes the execution of the robot to stop without errors.
Generate Error	Generates an error.
Execute Command Line	Executes a command line or shell script. Ensure RoboServer has sufficient privileges for this operation

Action	Description
Change Proxy	Changes the proxy server.
Execute JavaScript	Executes JavaScript.

Output

This category contains step actions for returning values to the API that called this robot, sending e-mail and writing to files or logs.

Action	Description
Return Value	Returns a value from the robot.
Send Email	Sends an email. Note that the email is not sent during execution in Design mode in Design Studio.
Write File	Writes a new file or appends to an existing file.
Write Log	Writes a message to the log. This is useful when debugging a robot.

Test

This category contains conditional actions for testing, such as stopping the execution down the current branch if some condition is satisfied. This condition may depend on the contents of the found tag, a variable, or the existence of a given window.

Action	Description
Test Tag	Causes execution down the current branch to stop or continue, depending on the contents of the found tag.
Test URL	Causes execution down the current branch to stop or continue, depending on the URL contained in the found tag.
Test Value	Causes execution beyond the step to stop or continue, depending on a boolean value.
Test Variables	Causes execution beyond the step to stop or continue, depending on one or more variable values.
Test Row	Tests the number of columns in a table row.
Test Window	Causes execution beyond the step to stop or continue, depending on whether a specific window exists.
Test Page Type	Causes execution beyond the step to stop or continue, depending on the type of the page.
Test Cell Type	Tests the cell type, such as Blank or Number of the found range and causes execution beyond the step to stop or continue depending on whether all cells in the range are of the given type.

Excel

This category contains actions that are specially designed for Excel pages.

Action	Description
Extract Target	Extracts text, runs it through a list of data converters, and stores the result in a variable.

Action	Description
Extract Cell	Extracts content from an Excel page, runs it through a list of data converters, and stores the result into a variable.
Extract Selected Option	Extracts the text or value of the selected option, runs it through a list of data converters, and stores the result in a variable.
Extract URL	Extracts a URL from the found tag and stores it in a variable.
Extract Image	Extracts an image and stores it in a variable or a file. It can optionally store the content type and file name of the image in other variables.
Extract Screenshot	Extracts an image from the current page and saves it in a variable.
Extract Tag Attribute	Extracts a tag attribute from the found tag, runs it through a list of data converters, and stores it in a variable.
Extract Form Parameter	Extracts a form parameter from a form URL in the found tag.
Extract from Flash	Extracts content from a Flash object.
Extract from PDF	Extracts text from a PDF document contained in a variable.
Extract Binary Content	Extracts binary content from the current window.

Obsolete

This category contains step actions that have been replaced by newer versions or otherwise become obsolete. They are available only for backwards compatibility with robots written using earlier versions of Design Studio. Do not use these step actions in new robots.

Assign Variable

This action assigns a value to a variable. In most cases the value is a simple type. If the source of the value is another variable, the value a complex type if the variable itself (such as test), rather than a field (such as test.result), is selected from the list of variables. In all cases, the type of the target variable must be compatible with the incoming value.

Properties

Configure the Assign Variable action using the following properties.

Value

The value to assign to the variable. Use the Value Selector to specify the value.

Variable

The variable to assign the value to.

Branch Point

A Branch Point marks a point in a robot where execution is divided into several branches.

When robot execution reaches a Branch Point each branch is executed sequentially unless execution of a branch is terminated by an error. In that case execution continues from the point specified under the Error Handling tab in the step action view of the step where the error occurred.

The order in which the branches are executed is top down unless the outgoing connections are annotated with numbers, in which case the branches are executed in the order indicated by these.

Each branch is executed in the same state (page in the Page View, Cookies, etc.), except for global variables which will survive from one branch to the next. Any change to the outside world will also persist from one branch to the next. Such changes could be writing to a file, storing in a database, submitting a form on a web site, e.g. anything that has an effect in the real world (fx. buying a book on Amazon).

Branch Points have no properties and will be inserted or deleted automatically depending on whether they are needed or not. If the End step from a branch is removed leaving only one branch, the branch point will be deleted automatically.

Videos

You can view a brief [video](#) about Branches, Robot States, and Execution Paths, which is relevant to the understanding of Branch Points.

Calculate Key

This step provides the possibility to calculate the key for a variable value. The value must be of a complex type, i.e. of a type that is specified in a .type file and not one of the built-in simple types such as Number. At least one attribute in the type must be marked 'Part of Database Key'. Knowing the key of a value can be useful if it needs to be linked to another value (for instance as a secondary key in another table), or linked to data stored in a file.

Properties

Variable

Select the variable for which to calculate the key. Note to customers with legacy robots (older than version 7.2): The type of the variable must have a Standard type kind and not the specialized Database Output type kind which exists only for legacy purposes.

Key (output)

The variable in which the calculated key will be stored. The variable can be both a simple type variable and an attribute of a complex type variable.

Call REST Web Service

The Call REST Web Service action sends a request to a REST web service and returns the web service's response, which may be for instance XML, JSON or HTML. The response is either presented in HTML form as the current page or stored in a variable.

If the web service returns a fault, the message is not returned by the action. Instead, the action will generate an error which can be handled using the standard error handling mechanisms.

Properties

The Call REST Web Service action can be configured using the following properties:

URL

The base URL of the web service, excluding parameters. The URL can be specified in several ways using a URL Selector.

Request

Here, you specify the type of request to be made. REST supports four basic operations:

GET

Used for querying data. For GET requests, you can specify a number of parameters as name/value pairs. Click '+' to add a new parameter.

POST

Used for updating selected parts of data. For POST requests, you can either specify a number of parameters as name/value pairs or give the entire body of the request. If you specify the request with parameters, you must select whether to use POST (application/x-www-form-urlencoded) or MULTIPART (multipart/form-data) to encode the parameters. If you give the entire ('raw') body of the request, you must specify the content type of the request data.

For POST and PUT requests, MULTIPART encoding can be selected to enable file uploads. If a binary variable is selected as the value of a File Upload parameter, the bytes are submitted as-is. If Base 64 encoding is desired, the value of the parameter should be an expression `base64Encode(data)` where data is the name of the variable containing the binary value. In that case, it is also recommended to specify the value `base64` as Content Transfer Encoding - otherwise, this field can normally be left blank.

Important

PUT

Used for replacing data. See POST for a description of the different ways of specifying a PUT request.

Delete

Used for deleting data. For DELETE requests, you can specify a number of parameters as name/value pairs. Click '+' to add a new parameter.

Accept

The content types that will be accepted as response. By default, any type of response will be accepted. The accepted content types can be specified in several ways using a Value Selector.

Encoding

The encoding that will be used to encode special characters in the request. The encoding used for decoding the response, is controlled using the step option, on the Page Loading Tab.

Output

Here, you select what happens to the output of the web service call.

Load in browser

The result is loaded into the current window, just as if it had been the result of a Load Page action. You may configure the behavior of the browser using the Options property described below.

Store in variable

The result is stored in the selected variable.

Options

Here you can override the robot's options with the step's own options. An option that is marked with an asterisk in the Options Dialog will override the one from the robot's configuration. All other options will be the same as specified for the robot.

Call SOAP Web Service

The Call SOAP Web Service action sends a SOAP XML request to a web service and returns the web service's SOAP XML response. The response is either presented in XML (or HTML) form as the current page or set as the value of an XML variable.

There are two ways of creating the SOAP request:

- Manual Entry mode
- Assisted Entry mode

Assisted Entry

This mode helps in creating a SOAP request message. It parses the WSDL file, shows operations available for the Web Service and allows entering parameters for those operations.

Working in the Assisted Entry mode is done in the following way:

- load a WSDL file,
- select an operation,
- set values for the parameters,
- invoke the step.

Manual Entry

Since SOAP requests can be quite complex, you will typically use an external tool to generate the request and paste it into the SOAP XML Request property. The request can be dynamically altered by specifying XML from Expression to create a template SOAP request substituting literal values by expressions.

If the web service returns a SOAP fault, the message is not returned by the action. Instead, the action will generate an error which can be handled using the standard error handling mechanisms.

Properties for Assisted Entry

The Call SOAP Web Service action in the Assisted Entry mode can be configured using the following properties:

WSDL

Here you specify the WSDL file in a dialog window. The value can be set by using:

Load from URL

Provide a URL to a valid WSDL file.

Provide custom WSDL

Input contents of the WSDL file into the text area.

Operation

A list of operations available for the Web Service associated with the provided WSDL file is presented after specifying the WSDL file . Choose one of the operations.

Parameters

Shows a list of parameters for the selected operation. An editor for the currently selected parameter is shown below the list. There are two types of parameters:

- Simple types - the value can be specified in several ways using a Value Selector,
- Complex types - an XML stub is created, e.g. it allows you to add and remove items for array types.

Validate Against Schema

If checked, the XML of complex parameter types will be validated against the XML schema specified in the WSDL.

Log Request Message

If checked, the body of the SOAP request will be logged.

Web Service URL

The location of the web service operation is specified here. If set to "Automatic" (which is the default option), the web service URL is derived from the WSDL. Alternatively, the value can be specified in several ways using a Value Selector.

Properties for Manual Entry

The Call SOAP Web Service action in the Manual Entry mode can be configured using the following properties:

Web Service URL

The location of the web service operation is specified here. Web services generally use the HTTP protocol. The value can be specified in several ways using a Value Selector.

SOAP Action

This property can contain an optional SOAP action. The value can be specified in several ways using a Value Selector. The SOAP action is sent as part of the HTTP headers. The SOAP action is typically, but not always, a URL specifying the requested action

SOAP Request

This property must contain a valid SOAP XML request. By default the XML can be specified literally. To dynamically create the SOAP XML request you can choose XML from Expression or XML from Variable.

SOAP Version

This property specifies which version of the SOAP specification to use for sending the SOAP request. SOAP 1.1 and SOAP 1.2 are supported. When specifying SOAP 1.1 the Content-Type will be set to text/xml and the (optional) SOAP Action will be set using an additional HTTP header. When specifying SOAP 1.2 the Content-Type will be application/soap+xml and the (optional) SOAP Action will be set as the action parameter of the Content-Type HTTP header.

Common Properties

The Call Web Service action can be configured using the following common properties as well:

Output

Choose whether to output the SOAP response as an XML page or as the value of an XML Variable. In robots created with Kapow 7.2 or earlier, this may be Output Result as HTML Page, meaning that the XML will be transformed to an HTML representation.

Options

The robot's options can be overridden with the step's own options. An option that is marked with an asterisk in the Options Dialog will override the one from the robot's configuration. All other options will be the same as specified for the robot.

Change Proxy

This action changes the proxy server used in subsequent steps. Hereby, it allows the robot to switch between multiple proxy servers during its execution or use a specified proxy.

To use this action with auto select, you must specify a list of proxy servers that the action should switch between. See [Specifying a Proxy Server](#) for information on how to do this.

At each execution of the Change Proxy action a new proxy server is selected from the list. The proxy servers are selected in the order that they appear on the list, with the first one being chosen randomly at the first execution of the Change Proxy action.

See [Using Proxy Services](#) for more details.

Properties

The Change Proxy action can be configured using the following properties:

Remove Cookies

Specifies whether to remove all cookies when the proxy is changed. If the proxy is used to stay anonymous then cookies should be removed when changing proxy.

Auto Select

If checked, the step will select the next (round robin) proxy from the properties file described in [Specifying a Proxy Server](#). It will test that it is possible to connect to the proxy before selecting it. If Auto Select is not checked it will use the proxy specified manually in the properties explained below

Host Name

Specify the host name of the proxy.

Port Number

Specify the port number of the proxy.

User Name

Specify the user name to use for authenticating against the proxy.

Password

Specify the password to use for authenticating against the proxy.

Excluded hosts

Specify a list containing hosts that should be excluded from the proxy. Each host must be on a separate line.

Clear Named Tags/Ranges

This action unmarks a selected named tag or range, or all named tags and ranges, so that these will no longer be named in the subsequent steps.

Properties

The Clear Named Tags/Ranges action can be configured using the following properties:

Named Tags/Ranges to Clear

Specify which named tags or ranges to unmark, either a single one selected by name or all named tags and ranges in the current window.

Clear Web Storage

The Clear Web Storage step action clears data in the local and/or session storage. The local and session storages are used by some websites to persist larger amounts of data that can normally be stored in a cookie.

Related Step Actions

The [Load Web Storage](#) step action can be used to load new data into the local and/or session storage, or replace existing data. It does not remove the existing data, unless it overwrites it with a new value.

The [Extract Web Storage](#) step action is used to extract data from the local and/or session storage.

Properties

Clear Local Storage

When checked, the storage items from the local storage will be cleared. In a browser, the local storage is normally persisted across browser sessions, similarly to persistent cookies.

Clear Session Storage

When checked, the storage items from the session storage will be cleared. In a browser, the session storage is normally persisted for as long as the browser window or tab exists, similarly to a session cookie.

Key Pattern

If you wish to clear only the stored items with a particular key, you can specify a pattern that matches the key of interest. If you leave the field blank, all storage items will be cleared regardless of their keys. If you do specify a pattern, note that it must match the entire key.

Domain Pattern

If you wish to clear only the stored items that belong to a particular domain, you can specify a pattern that matches the domain of interest. If you leave the field blank, storage items of all domains will be cleared. If you do specify a pattern, note that it must match the entire domain.

Click

This action emulates a mouse click on the found tag.

This is the most common action to use for navigation such as following links, submitting forms, etc. It can be used when the robot should perform the same action as the browser when clicking on something. Depending on the found tag, the Click action will perform the necessary page loading, form submissions, JavaScript execution, and so on.

To emulate a mouse movement instead of a click, use the [Move Mouse To](#) and [Move Mouse From](#) actions.

Properties

Double-Click

Specify whether to emulate a double-click or a single click.

Right-Click

Specify whether to emulate a right-click or a left click.

Coordinates

When set to Automatic, the browser will select relevant coordinates to click. Alternatively, you can specify exactly which coordinates to click. These are specified in pixels relative to the upper left of the component (such as an image or button) clicked.

Options

The robot's options can be overridden with the step's own options. An option that is marked with an asterisk in the Options Dialog will override the one from the robot's configuration. All other options will be the same as specified for the robot.

Close Window

This action closes a window.

In Design Studio inserting a Close Window step is easily done by right-clicking on the window's tab and then choosing Close Window.

Properties

The Close Window action can be configured using the following properties:

Window to Close

Specify the window that should be closed (see the discussion on how to identify a window).

Options

The robot's options can be overridden with the step's own options. An option that is marked with an asterisk in the Options Dialog will override the one from the robot's configuration. All other options will be the same as specified for the robot.

Convert Variables

This action converts the values of one or more variables by running them through data converters and storing the results in the same or other variables. The Convert Variables action is used to convert values extracted from a particular web site to the values required in the variable(s) to return. It is also used for converting values in an input variable to the values used on a particular web site.

For every variable that should be converted, a conversion to the list of conversions should be added. Each conversion takes the value of a selected variable, passes it through the selected data converters, and writes the result in another (or the same) selected variable.

The two selected variables can be the same variable, or different variables, depending on where the converted variable value should be stored. A variable value can simply be copied from one variable to another by not selecting any data converters in the conversion.

Properties

The Convert Variables can be configured using the following properties:

Conversions

Specify the list of conversions to use.

Conversion Properties

The Convert Variables can be configured using the following properties:

From

Specify the variable holding the value to convert.

Conversions

Specify the list of data converters to apply to the variable value. This list may be empty, e.g. if the value of one variable should merely be copied to another variable.

To

Specify the variable in which to store the result of the conversion. This may be the same variable as specified in the "From" property or a different variable.

Videos

You can view a brief video giving an introduction to the Data Converter List and how to perform specific conversions.

Copy File

This action copies a file on the local file system where the robot is executed.

Note that the action is only performed during execution in Design mode in Design Studio, if the option Execute in Design Mode has been selected.

Properties

The Copy File action can be configured using the following properties:

Source File

This is the file system path or a file URL of the source file to be copied. This can be specified in several ways using a Value Selector. The path must be absolute, including the drive name, if any, and the directory path to the directory. Alternatively, it can be a file URL, e.g. file:/C:/temp/myFile, in which case it must be URL encoded. The separators / and \ may be used interchangeably.

Destination File

This is the file system path or a file URL of the destination file. This can be specified in several ways using a Value Selector. The path must be absolute, including the drive name, if any, and the directory path to the directory. Alternatively, it can be a file URL, e.g. file:/C:/temp/myFile, in which case it must be URL encoded. The separators / and \ may be used interchangeably.

Execute in Design Mode

If this is enabled, the action will be executed in Design Mode inside Design Studio. If this is disabled, the action will do nothing when navigating the robot in Design Mode.

Crawl Pages

The Crawl Pages action loops through the pages of a web site. In effect, it crawls the web site one web page at a time. Hence, the first iteration crawls the first page, the second iteration crawls the second page, and so on.

Note The Crawl Pages step action only exists in the Classic browser, it cannot be used in Webkit.

The Crawl Pages action accepts a loaded page as part of the input, such as the start page of the web site. The output contains the next crawled web page.

Properties

The Crawl Pages action can be configured using the following properties:

Basic Tab

Crawling Strategy

This property specifies the strategy (i.e. method) of crawling. The Breadth First crawling strategy crawls a web site in order to minimize the page depth. The Depth First crawling strategy crawls a web site in order to maximize the page depth.

Maximum Depth

This property specifies the maximum depth of a page. The depth of a page is its distance from the first page measured in number of clicks and/or number of items that the mouse must be moved over (e.g. in a popup menu). The depth of the first page is zero. If a page exceeds the maximum depth, then it will not be crawled.

Ignore Pages with Errors

This property specifies whether pages with errors are skipped silently. Note that an error is only generated if this property is unchecked, and if the general options of the action do not specify that the particular type of error (e.g. JavaScript error or load error) should be ignored.

Options

The robot's options can be overridden with the step's own options. An option that is marked with an asterisk in the Options Dialog will override the one from the robot's configuration. All other options will be the same as specified for the robot.

Crawling Tab

Crawl these Windows

These properties specify which windows are crawled.

The starting point of the crawling is the current window and - if the Frames property is checked - its frames. Other top-level windows present at the start will only be crawled if the Popup Windows property is checked, and not until new pages have been loaded into them.

Frames

This property specifies whether frames are crawled.

Popup Windows

This property specifies whether popup windows are crawled. Popup windows are defined as top-level windows other than the window that was current window at the start of the crawling.

Click these Tags

These properties specify the HTML tags that the Crawl Pages action should attempt to click.

Links

Hyper links (A tags).

Buttons

Tags with input type="button", input type="submit" and input type="image" tags.

Image Maps

Images with client side image maps. Note that the image tag itself must be within the crawled area of the page, while the map need not.

Other Clickable Tags

Tags with JavaScript onClick event handlers.

Other

Automatically Handle Popup Menus

This property specifies whether to automatically include popup menus in the crawled area of the page. It only takes effect if a partial area of the page has been selected for crawling, either by setting up one or more tag finders for the first page or - for subsequent pages - by making a Crawling Rule with a Crawl Selected Parts of Page definition.

Move Mouse Over Tags

This property specifies whether the mouse should be moved over tags that support the relevant JavaScript event handlers (onMouseOver, onMouseEnter or onMouseMove). This is typically necessary for popup menus.

Rules Tab

The first page is handled specially: Whether it's output is determined by the Output the Input Page property on the Output tab. If only a particular area of the first page should be crawled, the area(s) are selected using tag finders on the Crawl Pages step.

For pages other than the first page, crawling rules can be set up.

Crawling Rules

Each crawling rule has the following properties:

Apply to these Pages

This property specifies a condition on the URLs of the pages to which this rule applies.

How to Crawl

This property specifies how the page should be crawled.

Crawl Entire Page

The entire page should be crawled.

Crawl Selected Parts of Page

Only parts of the page should be crawled. The included and excluded areas of the page are specified using tag finders, which can be advantageously copied from a step. If no included areas are specified, the entire page - except the specified excluded areas - is crawled.

Do Not Crawl

None of the page(s) should be crawled.

Output the Page

This property specifies whether the page should be output.

Rule Description

Here, you may specify a custom description of the crawling rule. This description will be shown in the list of crawling rules.

In the case that multiple rules apply to a given page, the last rule in the list that applies to the page overrides the preceding rules and takes effect. This provides an opportunity to e.g. first create a general rule, which states that all pages with the domain yourdomain.com should be crawled and then later add a specific rule, which states that the page <http://yourdomain.com/uninteresting.html> should not be crawled.

For all Other Pages

This property specifies how pages are handled. Excluded are the first page and pages with specific rules.

Crawl Entire Page

The entire page is crawled and output.

Do Not Crawl

The page is neither crawled nor output.

Crawl Only These Domains

This property specifies the domains that may be crawled. If left blank, all domains may be crawled. Multiple domains can be specified, separated by spaces

Note A specified page not crawl and not output will not be loaded if the link that points to it is an anchor or area tag with no JavaScript event handlers. If there are JavaScript event handlers involved, or if the page is loaded through JavaScript execution in general, you should be aware that it may be loaded anyhow. Still, it will not be output.

If at any time during the crawling one of the windows (be it a frame or a top-level window) should be output, all of the windows will be made available to the steps following the step with the Crawl Pages action.

Visited Pages Tab

Skip Already Visited Pages

This property specifies whether already visited pages should be skipped, which is usually the case. The following properties specify how visited pages are detected:

Detect Already Visited Pages by URL

This property specifies whether visited pages should be detected using their URL. For anchor tags with no JavaScript event handlers, this is done by checking the linked URL so the page will not be loaded a second time. In other cases (buttons, tags with JavaScript event handlers etc.) and for anchor tags with a non-visited linked URL, the resolved URL of the page is checked after it has been loaded.

Detect Already Visited Pages by Content

This property specifies whether visited pages should be detected by content. This ensures that pages with different URLs but identical content are not crawled again. For instance, <http://www.yourdomain.com/> and <http://www.yourdomain.com/index.html> may point to the same page even though the URLs are different.

Output Tab

Output the Input Page

This property specifies whether the first page should be output. If enabled, the output of the first iteration (iteration 1) equals the input.

Output Page Again if Changed

This property specifies whether a given page should be output again if clicking or moving the mouse over some tag does not result in a page load. For instance, moving the mouse over an item that opens a popup menu will not result in a page load, so if you want to process the page with the popup menu visible,

this property must be checked. Note that regardless of the value of this property, the page is always crawled again to detect any added tags.

Show Overview Page

This property specifies whether to open a new window showing an overview page. The overview page contains a list of the URLs from each step up to the current point of the crawling. The URLs of pages that were visited but not output are shown in gray.

Store Current Depth Here

This property specifies a variable into which the current depth is stored.

Store Current Path Here

This property specifies a variable into which the current path is stored. The elements of the path are separated by semicolon, where each element consists of a space-separated list of the URLs at the current point of the crawling

Crawling an Entire Site

1. Add a step with the [Load Page](#) action that loads the main page.
2. Add a new step and choose the Crawl Pages action.
3. On the Rules tab, add a Crawling Rule that applies to all pages in the site, e.g. by specifying the domain that the pages belong to or by making a pattern that the URL should match. For these pages, the rule should specify "Crawl Entire Page" and "Output the Page".
4. On the Rules tab, set the "For all Other Pages" property to "Do Not Crawl".
5. After the step with the Crawl Pages action, add steps to handle each page, e.g. by extracting information into returned variables.

Crawling a Popup Menu

You can discover all pages linked directly to a popup menu without continually crawling from these pages.

We do not wish to continue crawling from these pages.

1. Add a step with the [Load Page](#) action that loads the main page.
2. Add a new step and choose the Crawl Pages action.
3. Select the menu bar as named tag.
4. Notice that the "Automatically Handle Popup Menus" option on the Crawling tab is checked.
5. On the Rules tab, add a Crawling Rule saying that for "All URLs" we "Do Not Crawl", but "Output the Page".
6. After the step with the Crawl Pages action, add steps to handle each page, e.g. by extracting information into returned variables.

Create Cookie

The Cookie Creator creates a cookie with the specified domain, path, name and (optionally) value and adds it to the set of current cookies. If a cookie with the specified domain, path and name already exists, the old cookie is replaced by the new cookie.

Properties

The Create Cookie action can be configured using the following properties:

Domain

Specify the domain of the cookie. The domain can be specified in several ways using a Value Selector.

Path

Specify the path of the cookie. The path can be specified in several ways using a Value Selector.

Name

Specify the name of the cookie. The name can be specified in several ways using a Value Selector.

Value

Specify the value of the cookie. The value can be specified in several ways using a Value Selector. This property is optional.

Secure

If checked the cookie is sent when loading from the given domain via HTTPs, if not set the cookie is set when loading from the domain via HTTP.

HTTP Only

If checked the cookie is a HTTP Only cookie. That is, the cookie will only be used when transmitting HTTP (or HTTPS) requests, but its value will not be available to client side script (such as JavaScript).

Create Page

The Create Page action creates a new page which replaces the old page in the current window. The page is processed similarly to what takes place in the [Load Page](#) step action. This also entails that any JavaScript present in the HTML of the new page will be executed, unless JavaScript execution is disabled in the options. The Create Page action may also be used to load non-HTML pages, e.g. XML documents.

Properties

The Create Page action can be configured using the following properties:

Contents

The content of the new page can be specified in several ways using a Value Selector. It is for instance possible to acquire the contents from a variable, be it a variable with text or even binary content. The type of the content (e.g. HTML) will be detected automatically. If the automatic detection is insufficient or if the content should be loaded differently (e.g. to load an HTML document as plain text), you can override the content type detection in the options.

Page URL

Here, you specify the page URL of the new page. This is, among other things, used to resolve any relative links or resource references in the page. This can be specified in several ways using a Value Selector.

Options

The robot's options should be overridden with the step's own options. An option that is marked with an asterisk in the Options Dialog will override the one from the robot's configuration. All other options will be the same as specified for the robot.

Delete File

This action deletes a file or a directory on the local file system where the robot is executed.

Note that the action is only performed during execution in Design mode in Design Studio, if the option Execute in Design Mode has been selected.

Properties

The Delete File action can be configured using the following properties:

File or Directory

This is the file system path or a file URL for the file or directory to be deleted. This can be specified in several ways using a Value Selector. The path must be absolute, including the drive name, if any, and the directory path to the directory. Alternative it can be a file URL, e.g. file:/C:/temp/newDir, in which case it must be URL encoded. The separators / and \ may be used interchangeably.

Delete Non Empty Directories

This is an option that is only relevant if deleting a directory. If not selected the action will only delete empty directories. If selected the action will delete the directory including all files and subdirectories and it will do so recursively for all the subdirectories.

Execute in Design Mode

If this is enabled, the action will be executed even in Design Mode inside Design Studio. If this is disabled, the action will do nothing when you navigate the robot in Design Mode.

Delete from Database

This step allows you to delete a value previously stored in a database. The database connection must be configured in Settings

Properties

This step allows you to delete a value previously stored in a database. The database connection must be configured in Settings

Database

Specify the database to delete from. Select or hard code a value at design time, or dynamically construct the database name at runtime using a variable, an expression or converters - an error will occur if no database with this name exists when the robot is executed.

Variable

Select the complex type variable containing the value to delete.

Key

Specify the unique key for the value to delete. The key may be defined in the variable (by marking attributes as "Part of Database Key" in the variable type), or can be defined using a Value Selector (excluding the value-parameter).

Execute in Design Mode

If this is enabled, the step will be executed even in Design Mode inside Design Studio. If this is disabled, the step will do nothing when you navigate the robot in Design Mode.

Device Automation

This action creates a [device automation](#) step. Before using the Device Automation feature, you must [configure](#) Automation Device and create an [Automation Device Mapping](#).

Properties

Configure the Device Automation step using the following properties.

Input Value

Provide an input value for the device automation workflow. If you provide values in this property before editing a new device automation step, when you click **Edit**, the values are automatically added to the Device Automation robot.

Output Mapping

Assign a variable to hold the output value from the Device Automation step.

Required Devices

Specify the device mapping for the Device Automation step. The robot automates the devices associated with this mapping. Mapping information is required for automating Windows devices and it is not required for automating terminals. If you change the mapping, click Refresh to check the connection. See [Automation Device Mapping](#) for more information.

Workflow: Edit

Click **Edit** to open the [Device Automation Editor](#) to edit the Device Automation workflow.

See [Use Device Automation](#) for more information.

Divide Table

The Divide Table action is a loop action capable of dividing a table into one or more sub-tables. The Divide Table action searches the rows in a table to find one or more dividers and then splits the table into several sub tables based on these dividers. A row is a divider if at least one of the specified criteria is satisfied.

Properties

The Divide Table action can be configured using the following properties.

Divide at Rows Matching this Pattern

In this field a pattern can be entered. A table row that matches the pattern is considered a divider and will cause the creation of a new table. Note that the pattern must match the entire row.

Divide at Rows Not Matching this Pattern

In this field a pattern can be entered. A table row that does not match the pattern is considered a divider and will cause the creation of a new table. Note that the pattern must match the entire row to prevent the row from becoming a divider.

Include This in Row Matching

Specifies what should be included from a row when matching against the pattern.

- "Only Text" specifies that only the text should be included.
- "HTML" specifies that the whole HTML should be included.

Ignore Case in Row Matching

Specifies whether case should be ignored during row matching. Check this property if case should be ignored.

Divide at Rows with Min. No. of Columns and Divide at Rows with Max. No. of Columns

These properties specify an interval for the number of table columns in a row. If the number of columns in a row is within the interval the row is considered a divider, thus resulting in a new table.

First Sub Table Number

The number of the first sub table to loop from. The number can be specified to count either forward from the first sub table, or backwards from the last sub table.

Last Sub Table Number

The number of the last sub table to loop to. The number can be specified to count either forward from the first sub table, or backwards from the last sub table.

Place Divider Row in Table Header

If this property is checked then the located divider row will be placed inside a <thead>-tag of the sub table. If it is not checked then the divider is kept as in the sub table.

This property does not apply when dividing tags in XML documents.

Examples

Assume the found tag looks like this:

```
<table>
  <tbody>
    <tr>
      <th> Model </th>
      <th> Description </th>
      <th> Price </th>
    </tr>
    <tr>
      <td> XXX </td>
      <td> New Model </td>
      <td> 200 </td>
    </tr>
```

```

<tr>
  <th> Model </th>
  <th> Description </th>
  <th> Price </th>
</tr>
<tr>
  <td> YYY </td>
  <td> Old Model </td>
  <td> 100.5 </td>
</tr>
</tbody>
</table>

```

If the Divide at Rows Matching this Pattern property is set to `.*descript.*` and the Place Divider Row in Table Header property is not checked, the output in the first iteration will be:

```

<table>
  <tbody>
    <tr>
      <th> Model </th>
      <th> Description </th>
      <th> Price </th>
    </tr>
    <tr>
      <td> XXX </td>
      <td> New Model </td>
      <td> 200 </td>
    </tr>
  </tbody>
</table>

```

and in the second iteration:

```

<table>
  <tbody>
    <tr>
      <th> Model </th>
      <th> Description </th>
      <th> Price </th>
    </tr>
    <tr>
      <td> YYY </td>
      <td> Old Model </td>
      <td> 100.5 </td>
    </tr>
  </tbody>
</table>

```

Divide Text

The Divide Text action divides the text contained in the found tag into pieces using a pattern and an expression. It is useful when looping over these pieces in a subsequent step.

Properties

The Divide Text action is configured using the following properties:

Pattern

Specify a pattern that will be matched against the text in the found tag. For every match of the pattern, the expression in the Output Expression field will be evaluated. The found tag will then be replaced by a ``-tag, which, for each match of the pattern, contains the result of the expression surrounded by another ``-tag.

Ignore Case

If this property is checked, then the pattern matching will be case insensitive.

Output Expression

This field contains an expression that is evaluated for every match of the pattern.

Example

If the found tag is the "Kapow Software" text on this page:

```
<html>
  <body>
    <p>
      Kapow Software
    </p>
  </body>
</html>
```

and the Pattern is set to "\S+\s?" (meaning at least one non-whitespace character, followed by an optional whitespace), and the Output Expression is set to "\$0" (meaning the entire matched text), then the output will be:

```
<html>
  <body>
    <p>
      <span>
        <span>Kapow</span>
        <span>Software</span>
      </span>
    </p>
  </body>
</html>
```

Do Nothing

The Do Nothing action does nothing.

This action is useful when adding comments to a robot.

End Step

The End Step marks the end of a branch in a robot.

This step is a useful marker to have at the end of a branch, since clicking on it enables all steps in the branch to execute. Without it another step would have to be inserted at the end in order to be able to execute the last step of the branch.

The End Step is not associated with any action and is comparable to an action step with a [Do Nothing](#) action when it comes to its execution. An End Step cannot be deleted, but several branches may share the same End Step.

Note The End Step does not stop execution of a robot. For this you should use an action step with a [Stop](#) action.

Enter Password

This action enters a password in a password field in a form.

This action is similar to the [Enter Text](#) action, except that when a fixed password is specified, the password is not visible to the user in Design Studio and in saved robot files.

The found tag must be a password field.

Note that entering the password may trigger execution of JavaScript if there are any registered event handlers on the password field.

Properties

The Enter Password action can be configured using the following properties:

Password to Enter

Specify the password to enter in the password field. The value can be specified in several ways using a Value Selector.

Obtain focus by

Indicates how you want the robot to set focus to the selected tag.

Select all text before typing

Indicates if the existing password should be selected before entering the password.

Options

The robot's options can be overridden with the step's own options. An option that is marked with an asterisk in the Options Dialog will override the one from the robot's configuration. All other options will be the same as specified for the robot.

Enter Text

This action enters a text in a found tag, which must be either a text field, a text area, a password field, a file field, a hidden field, or a tag whose content is editable.

To enter a fixed password in a password field, consider using the [Enter Password](#) action instead in order to prevent the password from being visible to the user in Design Studio and in saved robot files.

Note that entering the text may trigger execution of JavaScript if there are any registered event handlers on the field or tag.

Properties

The Enter Text action can be configured using the following properties:

Text to Enter

Specify the text to enter. The value can be specified in several ways using a Value Selector.

Obtain focus by

On some websites it is necessary to set focus on the input field before entering text. Use the **Obtain focus by** option to set focus on the input field.

Select all text before typing

Sometimes it might be necessary to select the existing text in a field to ensure that it is overwritten when entering new text. Use the **Select all text before typing** option to select the existing text in a field.

Execute Command Line

This action executes a command line (external program)

Properties

The Execute Command Line can be configured with the following options

Command Line

The command line to execute. The value is configured using a [Value Selector](#) On Windows the command line is used as an argument to "cmd.exe /C". On other platforms the command line is used as an argument to "/bin/sh -c"

Extract

If the program writes text to the console, the extraction of the text is configured here, the options are

- "Nothing" extracts nothing
- "Stdout" extracts the text written to stdout into a variable
- "Stderr" extracts the text written to stderr into a variable
- "Separate stdout and stderr" extracts the text written to stdout and stderr into two separate variables
- "Joined stdout and stderr" extracts the text written to stdout into a single variable

If the program writes non-ASCII characters to the console, you can specify the encoding used to read the text. On western European Windows versions the console will most likely use cp858 also known as "Latin-1, MS-dos, with Euro". Other platforms will most likely have to use utf-8 for encoding to read console text, but this is environment specific.

Store Exit Code Here

Specifies the variable the exit code will be stored in. When a program is done executing it returns an exit code, specifying the status of the execution. 0 means success, other values indicate some kind of error, but the meaning of the error is program specific (although there is some consensus in the area, fx. a value of 2 usually means File not found). If no variable is specified, the exit code will be discarded.

Execute in Design Mode

If this is enabled, the action will be executed even in Design Mode inside Design Studio. If this is disabled, the action will do nothing when you navigate the robot in Design Mode.

Note The program inherits the working directory and environments from Design Studio

Note The step has no timeout, and will wait until the external program completes

Execute JavaScript

This action executes JavaScript on the current page, or your own custom JavaScript.

Note that most step actions will automatically execute relevant JavaScript as part of their operation, so you generally do not need to use the Execute JavaScript action unless you have special needs for executing JavaScript.

The Execute JavaScript action supports the following ways in which HTML can contain JavaScript:

- `<script>`-tags, which can contain multiple lines of JavaScript to be executed, or can refer to external JavaScript files.
- event handlers, which may appear as special attributes on tags, and they always begin with "on", such as, `onClick` or `onMouseOver`. They may also be attached from JavaScript without being visible in the HTML source.
- JavaScript URLs, which specify the JavaScript: Protocol with values for tag attributes where there can be a URL, e.g. ``

Properties

The Execute JavaScript action can be configured using the following properties.

JavaScript

This property specifies which JavaScript you want to execute:

- **JavaScript in All `<script>` Tags** executes all of the `<script>`-tags in the current page.
- **JavaScript in Selected `<script>` Tag** executes a single found `<script>`-tag.
- **JavaScript in URL** executes the JavaScript in a JavaScript URL, as specified by the JavaScript: Protocol.
- **JavaScript in Event Handler** executes the JavaScript in an event handler in a tag. The specific event handler that should be executed must be chosen from the dropdown box.
- **Custom JavaScript** executes your own custom JavaScript.
- **Custom JavaScript from Expression** executes your own custom JavaScript. This is similar to the Custom JavaScript option, except that an [expression](#) can be entered instead of a fixed text. For a list of JavaScript functions check [Convert Using JavaScript](#)

Options

The robot's [options](#) can be overridden with the step's own options. An option that is marked with an asterisk in the Options Dialog will override the one from the robot's configuration. All other options will be the same as specified for the robot.

Execute SQL

The Execute SQL action submits an SQL statement to a database and optionally stores the number of affected rows in a variable. Any other results returned by the database are ignored. In other words, this action is intended for SQL insert, update, and delete statements, but can also be used to invoke stored procedures and the like. The SQL is specified using an [expression](#).

Note that the SQL is not executed during execution in Design mode in Design Studio.

Important Do not execute `use <Some Other DB>` command in the SQL statements, because this will change the results of all future SQL commands (in the same robot or others).

Properties

The Execute SQL action can be configured using the following properties:

Database

Choose which database this action should submit its query to by using the drop-down list of databases available to Design Studio.

SQL

This field must contain a valid SQL statement in the form of an [expression](#). The value of this expression is submitted to the chosen database.

Modified Rows

Choose a text or integer variable in which to store the number of rows affected by the SQL statement. This is optional.

Execute in Design Mode

If this is enabled, the step will be executed even in Design Mode inside Design Studio. If this is disabled, the step will do nothing when navigating the robot in Design Mode.

Extract

The Extract action extracts text and stores it in a variable.

There is possibilities for specifying what content should be extracted such as only the text, or everything including the tags. Before the text is stored, it can be processed using a list of [data converters](#), and optionally trimmed for leading and trailing spaces.

The simplest way to use the Extract action is to extract from a single found tag. It is also possible to extract from a *tag range*, i.e. all tags from one found tag to another found tag.

Properties

The Extract action can be configured using the following properties:

Extract From

Specifies the part of the found tag that will be extracted.

- **Found Tag** specifies that the entire found tag should be extracted.
- **Tag Range** specifies that a range of tags should be extracted. Begin and end tags and whether or not to include these tags in the range can be selected.

Extract This

Specifies what content should be extracted.

- **Only Text** specifies that only the text should be extracted.

- **Structured Text** specifies that only the text should be extracted, but that it should be structured similarly to how it would appear in a browser. The system can guess at the location of a heading, and insert text before and/or after. Properties:
 - Include Aligned Tables and Images**
Specifies that the tables and images that are aligned to the left or right of the text are included in the output text. Disabling this can sometimes result in removing the desired content.
 - Include URLs**
Specifies that the actual URLs in link tags will be included in the output text.
 - Include Image Text Alternatives**
Specifies that the text representation of images will be included in the output text.
 - Include Form Fields**
Specifies that the text representation of form fields will be included in the output text.
 - Insert This Before a Heading**
Specifies that this action should guess at the location of headings and insert the specified text before them.
 - Insert This After a Heading**
Specifies that this action should guess at the location of headings and insert the specified text after them.
- **Advanced Structured Text** specifies that only the text should be extracted, but that it should be structured similarly to how it would appear in a browser. Tag names can be converted into any text. Properties:
 - Include Aligned Tables and Images**
Specifies that the tables and images that are aligned to the left or right of the text are included in the output text. Disabling this can sometimes result in removing the desired content.
 - Include URLs**
Specifies that the actual URLs in link tags will be included in the output text.
 - Include Image Text Alternatives**
Specifies that the text representation of images will be included in the output text.
 - Include Form Fields**
Specifies that the text representation of form fields will be included in the output text.
 - Tag Conversions**
Specifies the tag conversions to use. A tag conversion is on the form tag=text. For instance "<h1>=<head1>" and "</h1>=</head1>" would convert HTML headings level 1 to special <head1>-tags. Please note that the right sides of the conversions can be anything, they need not be ordinary tags.
- **HTML** specifies that the whole HTML should be extracted.
 - Format HTML**
Specifies that the HTML should be pretty-printed.
 - Encode URLs**
Specifies that URLs in attribute values should be HTML encoded. This is highly recommended, as it is necessary to generate standard compliant HTML that will work consistently across different

browsers. In some cases when the HTML is to be subjected to simple processing for recognizing and comparing URLs it may, however, be necessary to leave the URLs unencoded.

Extract Relative URLs

Specifies that all URLs should be extracted as relative. Thus, if present, the base part of the URL is removed.

- **XML** specifies that the whole XML should be extracted. This only works if the page is an XML page.

Include XML Declaration

Specifies that the XML Declaration (e.g. `<?xml version="1.0" encoding="UTF-8"?>`) should, if present, be included in the extracted XML. This means that one may extract part of an XML document and get a new XML document with a proper declaration at the top.

Converters

An optional list of data converters that should process the text.

Trim Spaces

If selected, spaces at the start and end of the text will be removed before storing the text in the variable.

Variable

Specifies the variable in which to store the extracted text.

Extract As HTML

The Extract As HTML action extracts a part of a spreadsheet document as an HTML table and stores it in a variable. The range finder of the step determines what is extracted and this may be either a part of a single sheet or all the information properties.

Properties

The Extract Cell action can be configured using the following properties:

Include Headers

This property specifies whether or not to include the spreadsheet headers (1,2,3,4 and A,B,C,D, etc.) in the generated table.

Extract This

This specifies what is extracted from the cells, but has no effect for extraction of information properties. There are three possible choices:

- "Formatted Values" specifies that the formatted should be extracted, e.g. numbers will be extracted as the view shows these and not the internal representation with extra decimal point.
- "Plain Values" specifies that the internal representation is extracted, e.g. numbers are extracted with full precision and dates are extracted as number of days since January 1, 1900. Cells for which there are no difference between formatted and plain values, e.g. cells containing text or logical values, the extracted values are the same as for "Formatted Values".
- "Formulas" specifies that the formulas should be extracted. For cells that do not contain a formula the extracted values are the same as for "Plain Values".

Variable

The variable to store the generated HTML table in.

Extract Binary Content

This action extracts binary content from the Browser View. If a step has loaded binary content into the Browser View this data will not be shown, but the data may be extracted into a binary variable using Extract Binary Content in the next step.

Properties

The Extract Binary Content action can be configured using the following properties:

Store Data In

The variable in which to store the binary content. This must be a binary variable.

Content Type

The variable in which to store the content type of the data.

File Name

The variable in which to store the original file name from the location where the data was loaded from, e.g. the file name from the URL. This name may for instance be needed if saving to a file happens in a subsequent step in the robot.

Extract Cell

The Extract Cell action extracts content from a spreadsheet document, runs it through a list of data converters, and stores the result into a variable.

Properties

The Extract Cell action can be configured using the following properties:

Extract This

This specifies what is extracted from the cell. There are three possible choices:

- "Formatted Values" specifies that the formatted should be extracted, e.g. numbers will be extracted as the view shows these and not the internal representation with extra decimal point.
- "Plain Values" specifies that the internal representation is extracted, e.g. numbers are extracted with full precision and dates are extracted as number of days since January 1, 1900. Cells for which there are no difference between formatted and plain values, e.g. cells containing text or logical values, the extracted values are the same as for "Formatted Values".
- "Formulas" specifies that the formulas should be extracted. For cells that do not contain a formula the extracted values are the same as for "Plain Values".

Converters

An optional list of [data converters](#) that should process the content.

Variable

The variable to assign the value to.

Extract Cookie

The Extract Cookie action extracts the value of a cookie from the set of current cookies. The cookie is selected using regular expressions for domain, path and/or name. If more than one cookie matches the patterns, the value is extracted from the

Properties

The Extract Cookie action can be configured using the following properties:

Domain Pattern

Specify a [pattern](#) that matches the domain of the cookie. The pattern must match the entire domain of the cookie.

Path Pattern

Specify a [pattern](#) that matches the path of the cookie. The pattern must match the entire path of the cookie.

Name Pattern

Specify a [pattern](#) that matches the name of the cookie. The pattern must match the entire name of the cookie.

Variable

Here you specify the variable in which to store the extracted value.

Extract Form Parameter

The Extract Form Parameter action extracts a form parameter from a form URL in the found tag and stores the value in a variable.

Properties

The Extract Form Parameter action can be configured using the following properties:

Form Parameter Name

Specifies the name of the form parameter.

Converters

Data converters to apply to the extracted value before storing it in the variable.

Variable

The variable in which to store the resulting value.

Encoding Used in URL

Specifies the character encoding used in the URL. If the extracted value contains incorrect characters, change this encoding to the encoding used in the page that contains the URL, or the page that contains

the form from which the URL was created. The most commonly used encodings in form URLs are Unicode (UTF-8) and Latin-1 (ISO-8859-1).

Example

Consider this found tag:

```
<a href="http://www.abc.com/search?author=Johnson">
  Search
</a>
```

If Form Parameter Name is set to "author", the value "Johnson" will be extracted and stored in the selected variable.

Extract from Flash

This action extracts content from a Flash object in a found tag.

Static text, HTML fragments and images will be extracted from the Flash object and presented as an HTML page. Contained URLs, references to other Flash objects and configuration files will be converted to links in a list at the bottom of the page.

Properties

The Extract from Flash action can be configured using the following properties:

Include images

Specifies whether images should be extracted from the Flash object or not.

Options

The robot's options can be overridden with the step's own options. An option that is marked with an asterisk in the Options Dialog will override the one from the robot's configuration. All other options will be the same as specified for the robot.

Extract from PDF

This action extracts text and images from a PDF document contained as binary data in a selected binary variable.

Typically, the PDF document has been downloaded into the variable using an [Extract Target](#) step. The output from the "Extract from PDF" action is an HTML page containing the text and images extracted from the PDF document. In subsequent steps, the desired information can then be extracted from the page, in the same way as for other HTML pages.

Note that PDF documents do not contain structure information such as tables or paragraphs, only positions of texts and graphics, that might or might not be positioned to look like tables or paragraphs. This can make it difficult to extract the desired information from PDF documents. However, the Extract from PDF step will apply some heuristics to group the text into HTML paragraphs based on the available position information.

Properties

The "Extract Text from PDF" action can be configured using the following properties:

PDF Variable

The binary variable containing the PDF document as binary data.

Include Images

Specifies whether embedded images should be extracted. Note that not all images and graphics can be extracted from PDF documents; it depends on the way they have originally been embedded in the document.

Include Form XObjects

This option enables extraction of the *Form XObjects* from the PDF. *Form XObjects* groups objects within a PDF file. The objects may include text, images, vector elements, and etc. *Form XObjects* is usually used to store objects that are referenced multiple times within a document.

Include Positioning

Specifies whether the positions of the texts should be extracted. The positions may be useful to derive the structure of the document.

Include Formatting

Specifies whether the formatting (font names, sizes etc.) of the texts should be extracted. Like the positions, the formatting may be useful to derive the structure of the document.

Merge Text

As default the converter that generated the HTML from the PDF will merge text that is on the same line into one HTML element even if these are represented as different text in the PDF document. Though this may often desirable, it may in some cases have the effect that text that originally far apart will be merges together and appear to be right next to each other. A typical case where it would be desirable to turn this feature off is if the document contains more than one column. Turning the feature off will attempt to preserve the column structure.

Extract Hyperlink

This action extracts a hyperlink from a cell in a spreadsheet.

Properties

The Extract Hyperlink action can be configured using the following properties:

Converters

An optional list of [data converters](#) that should process the content.

Variable

The variable to assign the value to.

Extract Image

This action extracts an image from the found tag and stores it in a variable or to a file.

The action can also optionally store the actual content type and file name of the extracted image in other variables.

Properties

The Extract Image action can be configured using the following properties.

Store In

Specifies where to store the extracted image. There are two choices for this:

Variable

Specifies the variable in which to store the extracted data. The variable must be of type Image or Binary. Using the specialized Image variable is recommended as it will be possible to see a preview of the extracted image in the Variables view.

File

Specifies the file to write the data to

File Name

Specifies the name and extension of the file.

Auto

With this option a file name is generated automatically using the following strategy:

1. First the content disposition header of the response is inspected to see if it has a filename parameter and if so that name will be used.
2. Next the URL is inspected to see if it contains a file name and if so that name will be used.
3. If none of the above options succeed then an error is generated.

Value, Variable, Expression and Converters

The value can be specified in several ways using a [Value Selector](#).

Directory

Specifies the directory where the file will be placed. The value can be specified in several ways using a Value Selector.

Create Directories

Specifies whether to create all the directories, in the specified path, that does not exist. If the option is selected the directories are created. If the option is not selected the directories must exist and if not an error is generated.

Override Strategy

This specifies a strategy for what to do when the selected file already exists.

Override File

Any existing file will be replaced.

Never Override File

Ensures that an existing file will never be replaced. If the file exists then an error is generated.

Create a New File

This option ensures that a new file will always be created. If a file with the selected name already exists then a new unique file name will be generated for the new file. This new file name will be the originally selected file name with a serial number added to the end just before the extension, e.g. myImage_1.png where _1 was added to the original file name myImage.png.

Store Meta Data In

Specifies variables to be used to store meta data about the extracted image.

Content Type

Specifies an optional variable in which to store the content type of the image. For example, the content type could look like this: image/gif

File Name

Specifies the optional variable in which to store the file name of the extracted image. If the image is saved to a file then the file name will be the full path of the file actually used. If the image is loaded into a variable then the file name will be the file name of the original resource (obtained from the URL or from the content disposition header for the response).

Options

The robot's [options](#) can be overridden with the step's own options. An option that is marked with an asterisk in the Options Dialog will override the one from the robot's configuration. All other options will be the same as specified for the robot.

Extract JSON

The Extract JSON step action extracts the part of a JSON value found by the JSON finder as a JSON value into a variable. The extracted value must itself be valid JSON, e.g. an object, array or a basic value. In other word you cannot extract a name/value pair "answer" : 42 even if you can select it in the view. Selecting such a name/value pair and extracting from it will result in only the value (42) being extracted.

Properties

The Extract JSON action is configured using the following properties:

Converters

An optional list of [data converters](#) that should process the text.

Variable

Specifies the variable in which to store the extracted text.

Extract Path

The Extract Path step action extracts the absolute path of the element found by the finder on the step. Path in this respect is to be thought of in a very general sense. In HTML and XML it is a tag path, e.g. html.body.div.text, in Excel it is a range, e.g. Sheet1!A5:B7 and in JSON it is the path used in JSON

finders, e.g. @top:.a[5].b. The path extracted is always an absolute path, i.e. not relative to a named tag, range etc. and without any wildcard (*) symbols. It is the kind of paths you see in the target views at the bottom of the Page Views, e.g. the Tag Path View in HTML/XML or the Cell Range View in Excel.

The extracted path may be used in the Finders of other steps in the Path property by referring to the variable containing the path.

Properties

The Extract Path action is configured using the following properties:

Variable

Specifies the variable in which to store the extracted path.

Extract Property Name

The Extract Property Name step action extracts the property name of a JSON value found by the JSON finder into a variable. The found item must be a property declaration (name/value pair) on an object, e.g. "answer" : 42..

Properties

The Extract JSON Property Name action is configured using the following properties:

Converters

An optional list of [data converters](#) that should process the text.

Variable

Specifies the variable in which to store the extracted name.

Extract Screenshot

This action extracts the whole page, or a part of it, as an image and saves it to a variable.

The tag finder specifies which area to extract. Use the tag path * to extract the whole page.

Properties

The Extract Screenshot action can be configured using the following properties:

Padding

Padding for the extraction are as follows. Note that positive values make the area larger, negative values make it smaller. The value can be specified in several ways using a [Value Selector](#).

Left (px)

Extra left margin (in pixels). May be negative.

Top (px)

Extra top margin (in pixels). May be negative.

Right (px)

Extra right margin (in pixels). May be negative.

Bottom (px)

Extra bottom margin (in pixels). May be negative.

Variable

The variable to assign the value to. It must may an image or binary variable.

Image Format

The format of the image. The possible values are PNG, JPG, BMP and GIF.

Load Images

Loads all images on page, if not already performed by the Load Page step (or similar).

Timeout (ms)

Timeout (in milliseconds) to use when loading images.

Extract Selected Option

The Extract Selected Option action extracts the selected option from a <select>-tag and stores it in a variable.

Either the option text or its value can be extracted. Before the text is stored, it can be processed using a list of [data converters](#), and optionally trimmed for leading and trailing spaces.

Properties

The Extract action can be configured using the following properties:

Extract Value

If selected, the value of the selected option will be extracted rather than the option text itself.

Converters

An optional list of data converters that can process the text.

Trim Spaces

If selected, spaces at the beginning and the end of the text will be removed before storing the text in the variable.

Variable

Specifies the variable in which to store the extracted text.

Extract Sheet Name

The Extract Sheet Name action extracts the name of a sheet in an spreadsheet document and stores it in a variable. The sheet is identified with the aid of a [Range Finder](#).

Properties

The Extract Sheet Name action can be configured using the following property:

Variable

The variable to store the sheet name in. This has to be a text variable.

Extract Source

This action stores the previewed data in a variable.

The step action only works on a preview.

Properties

The Extract Source action can be configured with the following properties:

Source

The type of source to extract from. Choose either Binary or Text. If the source is text, an encoding can be explicitly defined. The default encoding is the encoding provided by the web server.

Extract Data To

The variable to extract data to.

Extract Tag Attribute

This action extracts a tag attribute from the found tag, runs it through a list of data converters, and stores the result in a variable.

Properties

The Extract Tag Attribute action can be configured using the following properties:

Tag Attribute Name

The name of the tag attribute to extract.

Converters

The data converters to apply to the attribute value.

Variable

The variable to store the result into.

Example

Consider this found tag:

```

```

Assume that Tag Attribute Name has been set to "src", and that the Variable property has been set to "TemporaryData.shortText0". This will store the value "mypicture.gif" in the "shortText0" attribute of the "TemporaryData" variable.

Extract Target

This action extracts data from a target URL and stores it in a variable or to a file. If the selected variable can not store the actual data (such as attempting to store a PDF file in an XML variable), an error may be generated when executing the action.

The action can also optionally store the actual content type and file name of the extracted data in user specified variables.

Properties

The Extract Target action can be configured using the following properties:

Location

This property specifies which target URL to extract from.

URL

Enter the URL directly in the text field provided. Note that standard URLs using the HTTP protocol can be written in shorthand. For example, "http://www.kapowtech.com" can be written instead as "www.kapowtech.com".

URL in Found Tag

Specifies that the found tag contains the URL.

URL in Variable

Specifies that the URL should be read from a specified variable.

URL from Expression

Specifies an [expression](#) as the URL to open.

URL from Converters

Specifies a list of [data converters](#) whose output is used as the URL to open.

URL Loaded when Clicking

Specifies that the found node should be clicked, and the URL that would have been loaded as a result of this is used. For instance, if the result of clicking the found node resulted in a form submission, the data loaded by the Load Page step action will be the result of the form submission.

Store In

This specifies where to store the extracted data. There are two choices for this:

Variable

Specifies the variable in which to store the extracted data. The variable must be one of the following type: Binary, Image, PDF, Text, HTML, XML, or Excel.

File

Specifies the file which to write the data to.

Note If a robot is in the [Direct \(Minimal Execution\) Design Mode](#), then *Store In File* will work only in the Debug mode and on the RoboServer.

If a robot is in the [Full Execution \(Smart Re-execution\) Design Mode](#), then *Store In File* will work both in the Design and Debug modes.

File Name

Specifies the name and extension of the file.

Auto

With this option a file name is generated automatically using the following strategy:

1. First the content disposition header of the response is inspected to see if it has a filename parameter and if so that name is used.
2. Next the URL is inspected to see if it contains a file name and if so that name is used.
3. If none of the above options succeed then an error is generated.

Value, Variable, Expression and Converters

The value can be specified in several ways using a [Value Selector](#).

Directory

Specifies the directory where the file will be placed. The value can be specified in several ways using a Value Selector.

Create Directories

Specifies whether to create all the directories in the specified path that does not already exist. If the option is selected the directories are created. If the option is not selected the directories must exist and if not then an error is generated.

Override Strategy

Specifies a strategy for what to do when the selected file already exists.

Override File

Any existing file is replaced

Never Override File

Ensures that an existing file will never be replaced. If the file already exists then an error is generated.

Create a New File

Ensures that a new file is always created. If a file with the selected name already exists, a new unique file name is generated for the file. This new file name will be the originally selected file name with a serial number added to the end just before the extension, such as myData_1.dat where _1 was added to the original file name myData.dat.

Store Meta Data In:

Specify variables to be used to store meta data about the extracted data.

Content Type

This specifies an optional variable in which to store the content type of the data. For example, the content type could look like this for an image:

image/gif

and like this for a plain text:

text/plain; charset=iso-8859-1

File Name

This specifies the optional variable in which to store the file name of the extracted data. If the data is saved to a file then the file name will be the full path of the file actually used. If the data is loaded into a variable then the file name will be the file name of the original resource (obtained from the URL or from the content disposition header for the response).

Options

The robot's [options](#) can be overridden with the step's own options. An option that is marked with an asterisk in the Options Dialog will override the one from the robot's configuration. All other options will be the same as specified for the robot.

Extract URL

Extracts a URL from a tag and stores it in a variable. If the URL is relative, it can be converted to an absolute URL using the URL of the current page.

The URL can be extracted from an attribute, e.g. in the case of an <a>-tag with a href attribute. It can also be extracted as if the tag was clicked, e.g. in the case of a button whose onClick event handler loads a new page or submits a form. If the tag is a <form>-tag, either the value of the action attribute can be extracted or the URL that corresponds to the form submission (also when the POST method is used) can be extracted.

Properties

The Extract URL action can be configured using the following properties:

Extract How

Determines how the extraction is done

Automatic

The way to extract the URL is determined automatically.

From Tag Attribute

The URL can be extracted directly from the relevant attribute of the tag for the following tags:

- <a>
- <area>
- <form>
- <frame>
- <iframe>
- <script>
-

- `<input type="image">`
- `<param>`
- `<link>`
- `<meta>`
- `<body>`, `<table>`, `<tr>`, `<td>` or `<th>` where the tag has a background attribute

The From Tag Attribute extraction has two additional properties:

Execute JavaScript URLs

If the tag attribute contains a JavaScript URL and this property is checked, the JavaScript URL is executed in the hope that it will result in the load of a non-Javascript URL. No actual loading is done, however. If this property is not checked, the JavaScript URL itself is extracted.

Convert to Absolute URL

If this is checked, relative URLs are converted to absolute URLs.

Click Without Loading

The URL is extracted as if the tag was clicked, except that no loading is done. This can be useful for tags with `onClick` / `onMouseDown` / `onMouseUp` event handlers, or for buttons that submit forms.

Submit Form Without Loading

The URL is extracted as if the form was submitted, except that no actual requests are sent to the server. This type of extraction can only be applied to `<form>`-tags. To submit using a submit button, select the Click Without Loading extraction instead, using the submit button as the found tag.

Variable

The variable used to store to store the extracted URL.

Options

The robot's [options](#) can be overridden with the step's own options. An option that is marked with an asterisk in the Options Dialog will override the one from the robot's configuration. All other options will be the same as specified for the robot.

Extract Web Storage

The Extract Web Storage step action extracts data from the local and/or session storage from the current browser session. The local and session storages are used by some websites to persist larger amounts of data than can be stored in a cookie. The extracted web storage data is stored in a variable in JSON format. To further process the extracted data in a robot, a [Create Page](#) step can be used if it is configured to use the variable as input. The JSON will then be loaded into the browser view and additional steps can be added in order to, for instance, loop through the extracted values.

Properties

The Extract Web Storage action can be configured using the following properties:

Include Local Storage

When checked, the storage items from the local storage will be included in the extracted data. In a browser, the local storage is normally persisted across browser sessions, similarly to persistent cookies.

Include Session Storage

When checked, the storage items from the session storage will be included in the extracted data. In a browser, the session storage is normally persisted for as long as the browser window or tab exists, similarly to a session cookie.

Key Pattern

If only the stored items with a particular key are to be extracted, a [pattern](#) that matches the key of interest can be specified. If the field is left blank, all storage items will be included regardless of their keys. If a pattern is specified, note that it must match the entire key.

Domain Pattern

If only the stored items that belong to a particular domain are to be extracted, a [pattern](#) that matches the domain of interest can be specified. If the field is left blank, storage items of all domains will be included. If a pattern is specified, note that it must match the entire domain.

Output

The variable in which to store the extracted storage. The storage will be extracted in JSON format.

Find In Database

Find a value of complex type which was previously stored in a database. If the value is not found an error is generated; if the value is found it will be loaded. The database connection must be configured in Settings.

Properties

Find in Database can be configured using the following properties

Database

The database in which to find the value. A value can either be selected or hard coded at design time, or the database name can be dynamically constructed at runtime using a variable, an expression or converters - An error will occur if no database with this name exists when the robot is executed.

Variable

Select the variable to load the found value into. If any storable attribute has been added to its type since the value was stored, the value can not be loaded by using Find in Database. The variable must be of a regular complex type and not a specialized Database Output Types that existed prior to 7.2.

Key

The unique key for the value to find. This must be the key used when the value was stored. The key may have been defined in the type as "Part of Database Key", or it is can be defined using a variable, an expression or converters. If a value with the given key exists, the value will be loaded from the database into the variable. If no value was stored with the given key an error is generated; this error may be handled like any other error.

Only Override Empty Attributes

If this option is enabled, only empty attributes will be overridden with values loaded from the database. This provides the possibility to extract data before using Find in Database, and not have the extracted attribute values overridden.

For Each Browser Window

This action loops through the open browser [windows](#) (including frames and popup windows), selecting each in turn as the current window, i.e. the window that subsequent steps will work on.

For Each File

This action loops through the files in a directory.

The action loops through the files in the specified directory, optionally including the files contained in subdirectories as well (directly and indirectly). In each iteration, the file name of the current file, including the file path, will be stored in the selected variable.

If a file name pattern is specified, only the files whose file name matches this pattern will be included. Note that the pattern is matched against the file name without the path, and must match the entire name.

Properties

The For Each File action can be configured using the following properties:

Directory Name

The name of the directory to loop through. The name can be specified in several ways using a [Value Selector](#). The name must be an absolute directory name, including the drive name, if any, and the path to the directory.

Include Subdirectories

If this option is checked, the files contained in subdirectories (directly and indirectly) of the directory will be included; otherwise only files contained directly in the directory itself will be included.

File Name Pattern

If a [pattern](#) is specified here, only files whose name matches this pattern will be included. The pattern is matched against the file name without the path, and must match the entire name.

Store File Names Here

The variable in which to store the current file name in each iteration. The file name stored is the entire file name, including the drive name, if any, and the directory path.

For Each Item

The For Each Item action loops through all items of a JSON array. In each iteration, the appropriate item is marked as a named JSON.

The For Each Item action does not work on global variable.

Properties

The For Each Item action can be configured using the following properties:

Name

Has two options, **Auto** or **Named**. Auto gives the item a name which is number. The first Auto-numbered item will have number 1, the next number 2 etc. Note that the number may change if additional Auto-numbered items are inserted before this step (on the same page). Named gives the item a fixed and explicitly stated name, which has several advantages:

- It is easier to remember what the named item identifies if it has a well-chosen name
- An explicitly named item is not affected if another named item is inserted before it
- If you use the same name again in Set Named JSON, the name will simply be made to refer to the new item (useful for stateful in-page looping)

Keep Existing Named Items

If checked, the existing named items will be kept, otherwise these will be unmarked as named items and only the found item will be a named item after this step.

For Each Option

This action loops through the options in a drop-down box or list box, selecting one option in each iteration.

The found tag must be a <select>-tag.

Note that selecting the options may trigger execution of JavaScript, if there are any registered event handlers on the <select>-tag.

To select options without looping, use the [Select Option](#) or [Select Multiple Options](#) action.

Please see the Loops in Forms tutorial for more information.

Properties

The For Each Option action can be configured using the following properties:

Skip these Options

If any of the options should be skipped in the loop, they should be specified here.

Options

The robot's [options](#) can be overridden with the step's own options. An option that is marked with an asterisk in the Options Dialog will override the one from the robot's configuration. All other options will be the same as specified for the robot.

For Each Property

The For Each Property action loops through all properties (name/value pairs) of a JSON object. In each iteration, the appropriate property is marked as a named JSON.

The For Each Property action does not work on global variable.

Properties

The For Each Property action can be configured using the following properties:

Name

Has two options, **Auto** or **Named**. Auto gives the item a name which is number. The first Auto-numbered item will have number 1, the next number 2 etc. Note that the number may change if additional Auto-numbered items are inserted before this step (on the same page). Named gives the item a fixed and explicitly stated name, which has several advantages:

- It is easier to remember what the named item identifies if it has a well-chosen name
- An explicitly named item is not affected if another named item is inserted before it
- If you use the same name again in Set Named JSON, the name will simply be made to refer to the new item (useful for stateful in-page looping)

Keep Existing Named Items

If checked, the existing named items will be kept, otherwise these will be unmarked as named items and only the found item will be a named item after this step.

For Each Radio Button

This action loops through a group of radio buttons, selecting one of the radio buttons in each iteration.

The found tag must be one of the radio buttons in the group, *not* a tag containing all of the radio buttons.

Note that selecting the radio buttons may trigger execution of JavaScript, if there are any registered event handlers on the buttons.

To select a radio button without looping, use the [Select Radio Button](#) action.

Please see the Loops in Forms tutorial for more information.

Properties

The For Each Radio Button action can be configured using the following properties:

Options

The robot's [options](#) can be overridden with the step's own options. An option that is marked with an asterisk in the Options Dialog will override the one from the robot's configuration. All other options will be the same as specified for the robot.

For Each Tag

The For Each Tag action loops through a group of tags. In each iteration, the appropriate tag is marked as a named tag.

Most often, the loop should loop from the beginning to the end, such as looping through all the <tr>-tags of a table. However, it is also possible to configure the For Each Tag action to loop through only some of the tags, such as the last n tags in a sequence.

The For Each Tag action is similar to the [For Each Tag Path](#) action. The main difference is that the For Each Tag action only finds the immediate children of the found tag, whereas the For Each Tag Path action searches the entire subtree.

See the Basic Introduction to Looping tutorial for more information.

Properties

The For Each Tag action can be configured using the following properties:

Tag

The name of the tags to loop through, for example, **tr**.

Classes to Include

Specify the classes of nodes to include in the result. Conjunction (logical AND) is denoted by space and disjunction (logical or) is denoted by |. Conjunction takes precedence over disjunction, for example class1 class2 specifies the nodes that are both of class1 and class2, class1 | class2 | class3 specifies the nodes that are either of class1, class2, or class3, whereas class1 class2 | class3 class4 specifies the nodes that are either both of class1 and class2 or both of class 3 and class4.

Classes to Exclude

Specify the classes of nodes to exclude from the result. Conjunction (logical AND) is denoted by space, disjunction (logical or) is denoted by |, and the explicit absence of classes is denoted by \$. Conjunction takes precedence over disjunction, for example class1 class2 specifies the nodes that are both of class1 and class2, class1 | \$ specifies the nodes that are either of class1 or of no class at all, class1 | class2 | class3 specifies the nodes that are either of class1, class2, or class3, whereas class1 class2 | class3 class4 specifies the nodes that are either both of class1 and class2 or both of class 3 and class4.

First Tag Number

The number of the first tag to include in the loop. The number can be specified to count either forward from the first tag, or backward from the last tag.

Last Tag Number

The number of the last tag to include in the loop. The number can be specified to count either forward from the first tag, or backward from the last tag.

Tag Number Increment

Make the loop skip tags. For example, if an increment of 2 is specified, the loop will skip every second tag

Loop Backwards

Select that the loop should loop through the matching tags in reverse order. Please note that the loop will go through exactly the same tags as if it were looping forward just in reversed order. This means that the First Tag Number is referring to first tag in the selection of tags to loop over and not the first tag visited when looping (actually it will be the last).

Number of Tags to Include Before

The number of tags (of the same name) before the named tag to include in each output.

Number of Tags to Include After

The number of tags (of the same name) after the named tag to include in each output.

Tag Name

Has two options, **Auto** or **Named**. Auto gives the tag a name which is number. The first Auto-numbered tag will have number 1, the next number 2 etc. Note that the number may change if additional Auto-numbered tags are inserted before this step (on the same page). Named gives the tag a fixed and explicitly stated name, which has several advantages:

- It is easier to remember what the named tag identifies if it has a well-chosen name

- An explicitly named tag is not affected if another named tag is inserted before it
- If you use the same name again in Set Named Tag, the name will simply be made to refer to the new tag (useful for stateful in-page looping)

Keep Existing Named Tags

If this option is selected, existing named tags are kept along with the named tag marking the result of each iteration. If this option is not selected, existing named tags are removed, and each output state will only contain the named tag marking the result of the iteration.

Example

Consider this found tag:

```
<tbody>
  <tr>...
  <tr>...
  <tr>...
  <tr>...
  <tr>...
  <tr>...
</tbody>
```

With Tag Name set to "tr", First Tag Number set to 0 (From First), and Last Tag Number set to 1 (From Last), the For Each Tag action will loop through <tr>-tags 0, 1, 2, and 3. In each iteration, the named tag set by the action will be the appropriate <tr>-tag as shown below:

Iteration	Named Tag
1	<tr>-tag 0
2	<tr>-tag 1
3	<tr>-tag 2
4	<tr>-tag 3

For Each Tag Path

The For Each Tag Path action loops through all tags of a given type in the subtree of the found tag. In each iteration, the appropriate tag is marked as a named tag.

The For Each Tag Path action is very similar to the [For Each Tag](#) action. The main difference is that the For Each Tag action only finds the immediate children of the found tag whereas the For Each Tag Path action searches the entire subtree

See the Basic Introduction to Looping tutorial for more information.

Properties

The For Each Tag Path action can be configured using the following properties:

Tag Path

Specify the tag path which is to be looped through. The tag path is specified as in a [Tag Finder](#). All of the matching tags in the entire subtree will be found.

Classes to Include

Specify the classes of tags to include in the result. Conjunction (logical AND) is denoted by space and disjunction (logical or) is denoted by |. Conjunction takes precedence over disjunction, for example class1 class2 specifies the tags that are both of class1 and class2, class1 | class2 | class3 specifies the tags that are either of class1, class2, or class3, whereas class1 class2 | class3 class4 specifies the tags that are either both of class1 and class2 or both of class 3 and class4.

Classes to Exclude

Specify the classes of tags to exclude from the result. Conjunction (logical AND) is denoted by space, disjunction (logical or) is denoted by |, and the explicit absence of classes is denoted by \$. Conjunction takes precedence over disjunction, for example class1 class2 specifies the tags that are both of class1 and class2, class1 | \$ specifies the tags that are either of class1 or of no class at all, class1 | class2 | class3 specifies the tags that are either of class1, class2, or class3, whereas class1 class2 | class3 class4 specifies the tags that are either both of class1 and class2 or both of class 3 and class4.

First Tag Number

The number of the first matching tag to include in the loop. The number can be specified to count either forward from the first tag, or backward from the last tag.

Last Tag Number

The number of the last matching tag to include in the loop. The number can be specified to count either forward from the first tag, or backward from the last tag.

Tag Number Increment

Make the loop skip tags. For example, an increment of 2 is specified, the loop will skip every second tag.

Loop Backwards

Select that the loop should loop through the matching tags in reverse order. Please note that the loop will go through exactly the same tags as if it were looping forward just in reversed order. This means that the First Tag Number is referring to first tag in the selection of tags to loop over and not the first tag visited when looping (actually it will be the last).

Tag Name

Has two options, **Auto** or **Named**. Auto gives the tag a name which is number. The first Auto-numbered tag will have number 1, the next number 2 etc. Note that the number may change if additional Auto-numbered tags are inserted before this step (on the same page). Named gives the tag a fixed and explicitly stated name, which has several advantages:

- It is easier to remember what the named tag identifies if it has a well-chosen name
- An explicitly named tag is not affected if another named tag is inserted before it
- If you use the same name again in Set Named Tag, the name will simply be made to refer to the new tag (useful for stateful in-page looping)

Keep Existing Named Tags

If this option is selected, existing named tags are kept along with the named tag marking the result of each iteration. If this option is not selected, existing named tags are removed, and each output state will only contain the named tag marking the result of the iteration.

Example

Consider this found tag:

```
<table>
<tbody>
```

```

<tr>
  <td> 1 </td>
  <td> 2 </td>
</tr>
</tbody>
</table>

```

Set the Tag Path to td. The first iteration will set a named tag to <td> 1 </td> and in the next iteration, the named tag will be <td> 2 </td>

Now consider this found tag:

```

<table>
  <tbody>
    <tr>
      <td>
        <table>
          <tbody>
            <tr>
              <td> 1 </td>
              <td> 2 </td>
            </tr>
          </tbody>
        </table>
      </td>
      <td> 3 </td>
    </tr>
  </tbody>
</table>

```

Set the Tag Path to tr.td. The first iteration will set a named tag to

```

<td><table><tbody><tr><td> 1
</td><td> 2
</td></tr></tbody></table></td>

```

and in the next iteration, the **named tag** will be

```

<td> 3 </td>

```

For Each Text Part

This action splits a text at a specified delimiter pattern and loops through the part, assigning the next text part to a selected variable in each iteration.

Properties

The For Each Text Part step action can be configured using the following properties:

Input

The string to split can be specified in several ways using a [Value Selector](#). If the contents of a tag should be split, you must first extract the tag text into a variable using the [Extract](#) step action.

Delimiter

Specify the delimiter at which to split the text.

See the example below where we split a text using "," as delimiter.

Output

Specifies the variable in which the text part will be stored in each iteration.

Skip Empty Output

If checked, the loop will skip iterations whose output would have been a text of length zero. For example if looping over the text "a,b,c", the loop only contains three iterations (outputting "a", "b" and "c") if this property is checked. If the "Skip Empty Output" property is left unchecked, the loop contains four iterations (outputting "a", "b", "" and "c").

Example

We have the following input text:

```
apple,pear,banana,grape,kiwi,pineapple
```

We want to iterate over the fruits and perform some action for each; for example store the name of the fruit in a database.

As delimiter, we specify: ,

and as output variable we select Fruit.name.

In the first iteration, the Fruit.name variable will contain the value apple, in the second iteration it will contain the value pear. The entire loop will contain six iterations and in the final iteration the Fruit.name variable will contain the value pineapple.

For Each URL

The For Each URL action loops through the URLs contained in the found tag, optionally skipping duplicate URLs. The tags containing the URLs can be located at any depth inside the found tag. In each iteration, the appropriate tag is marked as a named tag.

See the Basic Introduction to Looping tutorial for more information.

Properties

The For Each URL action can be configured using the following properties:

URL Tags

Specifies the HTML tags whose URLs to loop through.

First URL Number

The number of the first URL to include in the loop. The number can be specified to count either forward from the first URL, or backward from the last URL.

Last URL Number

The number of the last URL to include in the loop. The number can be specified to count either forward from the first URL, or backward from the last URL.

Loop Backwards

Select that the loop should loop through the matching tags in reverse order. Please note that the loop will go through exactly the same tags as if it were looping forward just in reversed order. This means that the First Tag Number is referring to first tag in the selection of tags to loop over and not the first tag visited when looping (actually it will be the last).

URL Pattern

A [pattern](#) to match against each URL. The Action property then determines whether the URL should be skipped or not. The pattern must match the entire URL. If no pattern is specified, no pattern matching is done.

Action

If set to "Skip URLs that Match Pattern", all URLs that match the pattern will be skipped. If set to "Skip URLs that Do Not Match Pattern", all URLs that do not match the pattern will be skipped.

Skip Duplicate URLs

Specifies whether duplicate URLs (i.e. multiple identical URLs) should be skipped and hence not be looped through. Check this property the same URL should not be looped through more than once. (This is usually the case.)

Tag Name

Has two options, **Auto** or **Named**. Auto gives the tag a name which is number. The first Auto-numbered tag will have number 1, the next number 2 etc. Note that the number may change if additional Auto-numbered tags are inserted before this step (on the same page). Named gives the tag a fixed and explicitly stated name, which has several advantages:

- It is easier to remember what the named tag identifies if it has a well-chosen name
- An explicitly named tag is not affected if another named tag is inserted before it
- If you use the same name again in Set Named Tag, the name will simply be made to refer to the new tag (useful for stateful in-page looping)

Keep Existing Named Tags

If this option is selected, existing named tags are kept along with the named tag marking the result of each iteration. If this option is not selected, existing named tags are removed, and each output state will only contain the named tag marking the result of the iteration.

Generate Error

This action generates an error.

Useful if a situation has been detected that should be considered an error, such as if an error page has been received from a web site when trying to perform a certain action on the site. Using the Generate Error action, a robot error can be generated that will be handled like other errors that occur during the execution of a robot.

If it is just important to log that a certain situation has occurred and then continue execution along the current branch, consider using [Write Log](#) instead.

Properties

The Generate Error action can be configured using the following properties:

Error Message

The error message to include in the error. The error message can be specified in several ways using a [Value Selector](#). If no error message is specified, a default error message will be used.

Get File Info

This action fetches meta data about a file in the file system.

Properties

The Get File Info action can be configured using the following properties:

File Name

The name of the file to look for. The name can be specified in several ways using a [Value Selector](#). The name must be an absolute file name, including the drive name, if any, and the directory path to the file.

Store Last Modified In

Specifies the variable in which to store the last modified date.

Store Size In

Specifies the variable in which to store the size of the file, measured in bytes. This is the actual size of the file contents, not the file size on disk.

Get Iteration

This action gets the current iteration of an enclosing loop step and stores it in a variable.

When looping through a list of objects, this action is useful if the number of the current object that you are extracting is important.

Properties

The Get Iteration action can be configured using the following properties:

Loop Step

The number of the loop step whose iteration to get, either counting forward from the first loop step in the robot, or backward from the immediately enclosing loop step. For example, if 2 is entered and "From Last" is chosen, the iteration of the second innermost enclosing loop step will be chosen.

Store Iteration Here

The variable to store the iteration in.

Group Step

The Group Step is designed to contain other steps which can then be hidden by collapsing the group step into a single step and it is a convenient way to structure your robot. Grouping steps inside Group steps has no effect on the execution of a robot.

Group steps contain an expand/collapse icon (+/-) located at the top left corner. Clicking on this will expand/collapse the group step. When the group step is collapsed it will look similar to an ordinary step and all the steps inside will be hidden. When the group step is expanded its contained steps will be visible and have a layout that will resemble what you would see if these were not grouped. Group steps may also be expanded or collapsed by using the Expand All / Collapse All buttons on the Toolbar which will

perform these actions on all group steps in the robot, or by the Expand Groups / Collapse Groups which will perform these actions on all groups in the selection.

Steps are grouped (create a new group step containing the steps) by selecting the steps to group and using the Group action found in the Toolbar, the Edit menu or in the popup menu on steps. Only steps that form a subgraph may be grouped. This means that all steps must be directly connected to another step in the selection. There can only be one connection entering the selection (coming from a step outside the selection). All connections leaving the selection leading to steps outside the selection will be connected to the end of the group.

Steps are un-grouped (remove the group step, but keeping the grouped steps) by selecting the group steps to un-group and using the Ungroup action found in the Toolbar, the Edit menu or in the popup menu on steps.

At the beginning and end of the group step (when the group is expanded) a triangular marker can be noticed. This marks the entry and exit of the group step and if a right click is performed on one of these markers it will be possible to perform a selection of actions on the group step using the popup menu that appears, e.g. insert a branch at the start of the group.

Hide Tag

This action hides the found tags.

The hiding is done by configuring the style attribute of the tags. That is, the tags are kept in the page, but configured using styles to be invisible on the page.

This action is particularly useful if tags should not be visible when clipping from the page. Hiding the tags instead of removing them avoids breaking things like JavaScript that may rely on the page having a specific structure and contents.

Properties

The Hide Tag action can be configured using the following properties:

Adjust Layout Accordingly

If this option is selected, the hiding will be done in such a way that the layout of the page adjusts in order to use the space that was taken up by the tag. If this option is not selected, the hiding will be done in such a way that the tag continues to take up the same space in the layout, but is just not shown.

Insert Columns

This action inserts one or more columns in a spreadsheet.

Properties

The Insert Columns action can be configured using the following properties:

Insert Where

This option specifies where to insert the columns. Options are:

- First

- Before (Default)
- After
- Last

Number of Columns

The number of columns to insert.

Set as Named Range

Range name options are:

- Auto (Default)
- Named If you select Named, specify a name.
- If you select Named, specify a name.

Range Name

Has two options, **Auto** or **Named**. Auto gives the range a name which is number. The first Auto-numbered range will have number 1, the next number 2 etc. Note that the number may change if additional Auto-numbered ranges are inserted before this step (on the same page). Named gives the range a fixed and explicitly stated name, which has several advantages:

- It is easier to remember what the named range identifies if it has a well-chosen name
- An explicitly named range is not affected if another named range is inserted before it
- If you use the same name again, the name will simply be made to refer to the new range (useful for stateful in-page looping)

Insert Content

This action inserts the specified content into a document relative to the found tag.

The step action only works on XML variables. Note that this step neither validates the XML nor resolves entities.

Properties

The Insert Content action can be configured using the following properties:

New Content

The new content to insert.

Insert Tag Where

Choose where to insert the new tag relative to the found tag. Options are:

- As First Child of Found Tag
- As Last Child of Found Tag
- Before Found Tag
- After Found Tag

Note that tags can not be inserted in a text node. Instead, the surrounding tag must be selected.

Set as Named Tag

Select this property to set a named tag on the item.

Auto

Gives the item a name which is number. The first auto-numbered item is 1, the next is 2, and etc.

Named

Gives the item a fixed and explicitly stated name.

See [Named Tags, Ranges, and JSON](#) for details.

Insert JSON

This action inserts a new property (name/value pair) into a JSON object or a new item into a JSON array.

The step action only works on JSON variables.

Properties

The Insert JSON action can be configured using the following properties:

Insert What

This option defines a new property to insert. If this option is used then the found JSON value must be an object otherwise an error is produced. The new property is defined by the two properties:

Object Property

This option defines a new property to insert. If this option is used then the found JSON value must be an object otherwise an error is produced. The new property is defined by the two properties:

Name

This is the name of the new property. This must of course be a valid property name, e.g. quotation marks should be escaped.

Value

This is the value of the property which must be a valid JSON value, e.g. if you want to insert a text this must be quoted.

Array Item

This option defines a new item to insert. If this option is used then the found JSON value must be an array otherwise an error is produced. The new property is defined by the two properties:

Value

This is the value of the item which must be a valid JSON value, that is. if you want to insert a text this must be quoted.

Insert Where

Choose where to insert the new JSON relative to the found JSON value. The options are:

Before

This will insert the property or item before the found JSON.

First

This will insert the property or item as the first property in a JSON object or array.

Last

This will insert the property or item as the first property in a JSON object or array.

After

This will insert the property or item after the found JSON.

Set as Named JSON

Select this property to set a named JSON on the item.

Auto

Gives the item a name which is number. The first auto-numbered item is 1, the next is 2, and etc.

Named

Gives the item a fixed and explicitly stated name.

See [Named Tags, Ranges, and JSON](#) for details.

Insert Rows

This action inserts one or more rows in a spreadsheet.

Properties

The Insert Rows action can be configured using the following properties:

Insert Where

This option specifies where to insert the rows. Options are:

- First
- Before (Default)
- After
- Last

Number of Rows

The number of rows to insert.

Set as Named Range

Range name options are:

- Auto (Default)
- Named If you select Named, specify a name.

Range Name

Has two options, **Auto** or **Named**.

Auto gives the range a name which is number. The first Auto-numbered range will have number 1, the next number 2 etc. Note that the number may change if additional Auto-numbered ranges are inserted before this step (on the same page). Named gives the range a fixed and explicitly stated name, which has several advantages:

- It is easier to remember what the named range identifies if it has a well-chosen name
- An explicitly named range is not affected if another named range is inserted before it

- If you use the same name again, the name will simply be made to refer to the new range (useful for stateful in-page looping)

Insert Sheet

This action inserts a new sheet in a spreadsheet.

Properties

The Insert Sheet action can be configured using the following properties:

Insert Where

This option specifies where to insert the rows. Options are:

- First
- Before (Default)
- After
- Last

Name

This option specifies a name of the inserted sheet.

Insert Tag

The Insert Tag action inserts a new tag. Any JavaScript present in the HTML of the new tag will be executed, unless JavaScript execution is disabled in the [options](#).

Properties

The Insert Tag action can be configured using the following properties:

HTML of New Tag

Specify the HTML of the new tag. The HTML can be specified in a number of ways as described below.

Insert Tag Where

Choose where to insert the new tag relative to the found tag. Options are:

- As First Child of Found Tag
- As Last Child of Found Tag
- Before Found Tag
- After Found Tag

Note the following rules:

- If a new tag is inserted before an <html>, <head>, or <body> tag, it will become the first tag in <body> if the document contains a <body> tag. Otherwise, it will become the first tag in <html>.
- If you insert the new tag after a <head> tag, it will become the first tag in <body>.
- If you insert the new tag after a <html> or <body> tag, it will become the last tag in <body>.
- HTML tags can not be inserted in a text node. Instead, the surrounding tag must be selected.

Options

The robot's options can be overridden with the step's own options. An option that is marked with an asterisk in the Options Dialog will override the one from the robot's configuration. All other options will be the same as specified for the robot.

Specifying the HTML

The HTML of the new tag can be specified in the following ways:

HTML

Simply write the HTML of the new tag.

HTML from Expression

Write an [expression](#) whose result is used as the HTML of the new tag.

HTML from Expression and Pattern

Write a [pattern](#) which is matched against the found tag, and an expression whose result is used as the HTML of the new tag. Use this way of specifying the HTML if parts of the found tag should be used when creating the HTML of the new tag.

Pattern

A [pattern](#) which is matched against the found tag for the Insert Tag action. The pattern must match the entire found tag, otherwise an error will be generated.

Match Against

Specifies what the pattern should be matched against from the found tag.

- "Only Text" specifies that the pattern should be matched only against the text in the found tag.
- "HTML" specifies that the pattern should be matched against the HTML of the found tag.

Ignore Case

If this is checked, the pattern is matched against the input without regard to the character case; e.g. "KaPoW" is considered equal to "kApow".

Expression

This field contains an [expression](#) whose result is used to create the new tag. The expression can refer to the submatches of the pattern in the Pattern field using the \$n notation. For example, enter \$1 in the expression to get the first submatch in the pattern (i.e. the text that matches the contents of the first pair of parentheses in the pattern).

HTML Converted from XML Variable

Choose an XML variable whose content will be transformed to HTML and used as the HTML of the new tag.

Load File

This action loads a file, either into the browser or to a variable.

Properties

The Load File action can be configured using the following properties:

File Name

This property specifies the path to the file to load. The path may be constructed using an expression or converter.

Output

This specifies what to do with the file contents; either load it into the browser or store it in a variable.

Options

The robot's [options](#) can be overridden with the step's own options. An option that is marked with an asterisk in the Options Dialog will override the one from the robot's configuration. All other options will be the same as specified for the robot.

Load Page

This action loads a page from a URL obtained either from a link on the current page, or from somewhere else. Note that loading from a link on the current page is usually easier done by using the [Click](#) action to perform a click on that link.

Properties

The Load Page action can be configured using the following properties:

Location

This property specifies which URL to open. The URL can be specified in several ways using a [URL Selector](#).

Load Into

This property specifies which [window](#) to load the page into. The window can be an existing one or a new one. The following options are available:

- Automatic specifies that the page should be loaded into the same window as a browser would. If the page is loaded from a URL in the found tag, this will take into account "target" attributes etc. on the found tag.
- Existing Window specifies that the page should be loaded into a selected existing window (see the discussion on how to identify a window).
- New Window specifies that the page should be loaded into a new window. An optional name for the new window can be specified, and it can be selected which window should be registered as the opener of the new window (see the discussion on how to identify a window).

Options

The robot's [options](#) can be overridden with the step's own options. An option that is marked with an asterisk in the Options Dialog will override the one from the robot's configuration. All other options will be the same as specified for the robot.

Load Web Storage

The Load Web Storage step action loads data into the local and/or session storage. The local and session storages are used by some websites to persist larger amounts of data that can normally be stored in a cookie.

The data to load can be specified in the data field (see below for an example of how to do this), but this step action can also be used to load storage data that has been extracted using an [Extract Web Storage](#) step action.

Properties

The Load Web Storage action can be configured using the following properties:

Data

Specify the data to load into the local and/or session storage. Normally, this data is taken from a variable that stores the result of having used the Extract Web Storage action, but the data can also be entered or generated specifically.

The data must be specified in JSON format and must be specified as an array of objects. Each object must contain the following properties:

storage-type

The storage type must be either "session" or "local". Session storage will be loaded into the current window and will persist as long as its top-level window exists, similarly to a session cookie. Local storage is shared between all of the browser windows, similarly to a persistent cookie.

domain

The domain whose sites have access to the storage.

storage

An array of items that comprise the storage. Each item is an object with the following properties:

key

The name that is used to look up the item in the storage.

value

The stored value, which must be of type String.

Example

In this example, we wish to define one storage item named "help" with the value "http://help.kapowsoftware.com" in the local storage, and two storage items in the session storage, namely "product" with the value "Kapow" and "version" with the value "10". All storage items will be defined for the domain "www.kapowsoftware.com".

We enter the following data into the Load Web Storage step action:

```
[
  {
    "storage-type": "local",
    domain: "www.kapowsoftware.com",
    storage: [
      {
        key: "help",
        value: "http://help.kapowsoftware.com"
      }
    ]
  },
  {
    "storage-type": "session",
    domain: "www.kapowsoftware.com",
    storage: [
      {
        key: "product",
        value: "Kapow"
      },
      {
        key: "version",
        value: "10"
      }
    ]
  }
]
```

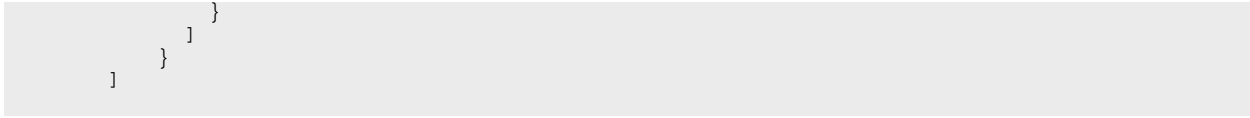

Loop Field Values

This action loops through a list of values, entering one into a text field in each iteration.

The found tag must be a `<textarea>` tag or an `<input>` tag of type "text" or "password".

Note that entering the value may trigger execution of JavaScript if there are any registered event handlers on the `<input>` or `<textarea>` tag.

To enter text without looping, use the [Enter Text](#) action.

See the Loops in Forms tutorial for more information.

Properties

The Loop Field Values action can be configured using the following properties:

Values

The values to loop through. These can be either:

a...z

The letters from a-z, in alphabetical order.

aa...zz

The two-letter combinations of a-z, in alphabetical order.

Number range

A range of integers. The numbers that define the endpoints of the range must be specified, as well as the size of the step taken in each iteration. E.g. setting "From" to 0, "To" to 100 and "Step" to 10 will cause the step to loop through the sequence 0, 10, 20, 30, 40, 50, 60, 70, 80, 90, 100.

List of values

Explicitly specify the values to loop through. The values must be separated by commas or placed on separate lines, and may be quoted with double quotes. Using the [Value Selector](#), a list from e.g. a variable can be obtained.

Options

The robot's options can be overridden with the step's own options. An option that is marked with an asterisk in the Options Dialog will override the one from the robot's configuration. All other options will be the same as specified for the robot.

Loop in Excel

The Loop in Excel action loops through different elements of a spreadsheet. An element in this context could be a sheet, a column, a row or a cell and is identified by the step's [Range Finder](#). In each iteration, the appropriate element is marked as anamed range.

Properties

The Loop in Excel action can be configured using the following properties:

Loop Over

This determines what kind of element the action will loop over. There are 4 possibilities for this:

Sheets

The action will loop over sheets in the spreadsheet document. No range finder is needed for this choice.

Columns

The action will loop over the columns in the range found by the range finder.

Rows

The action will loop over the rows in the range found by the range finder.

Cells

The action will loop over the cells in the range found by the range finder.

First Index

The number of the first element to include in the loop. The number can be specified to count either forward from the first element, or backward from the last element.

Last Index

The number of the last element to include in the loop. The number can be specified to count either forward from the first element, or backward from the last element.

Increment

Make the loop skip elements. For example, if an increment of 2 is specified, the loop will skip every second element.

Loop Backwards

Select that the loop should loop through the matching elements in reverse order. Please note that the loop will go through exactly the same elements as if it were looping forward just in reversed order. This means that the First Index is referring to first element in the selection of elements to loop over and not the first element visited when looping (actually it will be the last when looping backwards).

Range Name

Has two options, **Auto** or **Named**. Auto gives the range a name which is number. The first Auto-numbered range will have number 1, the next number 2 etc. Note that the number may change if additional Auto-numbered ranges are inserted before this step (on the same page). Named gives the range a fixed and explicitly stated name, which has several advantages:

- It is easier to remember what the named range identifies if it has a well-chosen name
- An explicitly named range is not affected if another named range is inserted before it
- If you use the same name again in Set Named Range, the name will simply be made to refer to the new range (useful for stateful in-page looping)

Make Directory

This action creates a new directory on the local file system where the robot is executed.

Note that the action is only performed during execution in Design mode in Design Studio, if the option Execute in Design Mode has been selected.

Properties

The Make Directory action can be configured using the following properties:

Directory

This is the file system path or a file URL for the directory to be created. This can be specified in several ways using a [Value Selector](#). The path must be absolute, including the drive name, if any, and the directory path to the directory. Alternatively it can be a file URL, e.g. file:/C:/temp/newDir, in which case it must be URL encoded. The separators / and \ may be used interchangeably.

Generate Error if Directory Exist

Makes the action generate an error if the directory already exists.

Create Directories

Specifies whether to create the necessary directories on the path before creating the directory. If not selected, then the action will fail if any directory on the path does not exist.

Execute in Design Mode

If this is enabled, the action will be executed even in Design Mode inside Design Studio. If this is disabled, the action will do nothing when you navigate the robot in Design Mode.

Make Snapshot

The Make Snapshot step action takes the page located in the current window and stores it in the file system, including any style sheets and images necessary to display the page as it was at the time when the snapshot was made. No JavaScript or server interaction is necessary to view the page at a later time - even if the content was dynamically generated.

Related Step Actions

For downloading a large number of interlinked pages, reuse shared resources and preserve links between the offline snapshots, consider using the [Rewrite Page](#) step action. Robots using the Rewrite Page step action need an external controller application to feed it URLs of pages and resources to download.

Properties

The Make Snapshot step action can be configured using the following properties:

Output Folder

The folder in which to output the snapshot. The main page (corresponding to the document in the current window) will be outputted in a file named index.html.

Download Resources

When enabled, images and other resources that have not already been loaded by the previous step actions will be downloaded and saved as part of the snapshot.

Options

The robot's options can be overridden with the step's own options. An option that is marked with an asterisk in the Options Dialog will override the one from the robot's configuration. All other options will be the same as specified for the robot.

Move Mouse From

This action emulates a mouse move away from the found tag.

This action is useful for closing JavaScript-based menus that open when the mouse is moved over them and close when the mouse is moved away from them.

To emulate a mouse movement to a tag, use the Move Mouse To action. To emulate a mouse click instead of a movement, use the Click action.

Properties

The Move Mouse From action can be configured using the following properties:

Options

The robot's options can be overridden with the step's own options. An option that is marked with an asterisk in the Options Dialog will override the one from the robot's configuration. All other options will be the same as specified for the robot.

Move Mouse To

This action emulates a mouse move to the found tag.

This action is useful for triggering JavaScript-based menus that open when the mouse is moved over them.

To emulate a mouse movement away from a tag, use the Move Mouse From action. To emulate a mouse click instead of a movement, use the Click action.

Properties

The Move Mouse To action can be configured using the following properties:

Options

The robot's options can be overridden with the step's own options. An option that is marked with an asterisk in the Options Dialog will override the one from the robot's configuration. All other options will be the same as specified for the robot.

New Window

This action creates a new [window](#).

Properties

The New Window action can be configured using the following properties:

Window Name

The name of the new window, if any. Leave the field empty if the new window should be unnamed.

Window Opener

The window that should be registered as the opener of the new window, if any (see the discussion on how to identify a window). The opener relationship may be important to JavaScript executing in the windows

Next

This action requests another iteration in a repeat loop created using the [Repeat](#) action.

In each iteration of the repeat loop, another iteration can be requested using the Next action. The windows, pages, etc. at the Next step will be sent back to the Repeat step and will become the output from the Repeat step in the next iteration. If no Next step is executed in a given iteration, that iteration will be the last one, and the repeat loop will end.

See the Repeat action for further information.

Please see the Repeat - Next tutorial for more information.

Normalize Table

This action normalizes a table by introducing extra cells where rowspan and colspan are used, which makes iterating over table columns or rows easier. The normalization only works if colSpan/rowSpan is part of the HTML source, not if it is created using CSS.

Since this action modifies the page, it can cause JavaScript or form submission to stop working, as these may rely on the structure of the page. This is however rarely a problem since the action is usually applied to data tables from which there is no further navigation.

Properties

Delete from Database can be configured using the following properties

Do not copy form fields

Is thi option is selected, any form fields (input, select, button, textarea) will not be copied when extra cells are inserted.

**Examples
colSpan**

Before

1	2
3	
4	5

After

1	2
3	3
4	5

rowSpan

Before

1	2	X
3		X
	4	X
5	6	X

After

1	2	X
3	2	X
3	4	X
5	6	X

colSpan and rowSpan

Before

1	2	3	4
5			6
7			
8	8	8	8

After

1	2	3	3	4
5	5	3	3	6

7	7	3	3	6
8	8	8	8	8

Obsolete Step

Some of the steps have been either replaced or removed in the newer versions of Kapow.

The step you are trying to get help for might have been created in one of the previous versions of the program. Please refer to the online help of the corresponding version of Kapow.

If you want to edit your robot in the newer version of Kapow, replace the obsolete step with one of the existing steps if possible. Refer to Release Notes document and *Upgrading Kapow* topic in the Kapow Installation Guide for upgrade instructions. Use our [customer support portal](#) for solving any problem you might have using Kofax Kapow.

Open Variable

This action opens a variable attribute - or a variable of simple type - in the view, making it possible to manipulate it through here. This provides a way to visually adjust the contents of variables, making it easier to, for instance, form the precise content required for a web service parameter.

The step action only works on XML, JSON or Excel variables.

Properties

The Open Variable action can be configured using the following property:

Variable

This property specifies which variable to open. The variable must be of type XML, JSON or Excel to be loaded in this way. Note, that pre-9.3 robots use a now deprecated XML attribute type, so these will have to be upgraded to the new XML type in order to be opened. For variables of simple type, this is done by editing the variable and selecting the new XML type. For variables of complex types, the relevant .type file must be changed to use the new XML attribute type instead of the old.

Press Key

This action emulates pressing a key on the keyboard.

The found tag can be any tag, that can assume focus and receive keyboard events.

This action is useful for sending key presses, like <TAB>.

Properties

The Press Key action can be configured using the following properties:

Key to press

The key to press.

Predefined

Select from the list. The list of predefined keys contains the most commonly used keys.

Value

Specify a value of the key to press. The value must be one of the Qt key codes in a decimal number. For the key names used by Qt, see <http://doc.qt.io/qt-4.8/qt.html#Key-enum>.

Variable

Specify a variable that contains the key code of the key to press. The key code must be one of the Qt key codes in a decimal number.

Expression

Specify an [expression](#).

Converters

Specify a [converter](#).

Focus on element

Focus on the element before pressing the key.

Options

The robot's options can be overridden with the step's own options. An option that is marked with an asterisk in the Options Dialog will override the one from the robot's configuration. All other options will be the same as specified for the robot.

Query Database

The Query Database action submits an SQL query to a database and loops through the results. The SQL should be specified using an [expression](#). At each iteration of the result loop, the values of the current row in the result set can be assigned to variables.

Properties

The Query Database action can be configured using the following properties:

Database

Choose which database this action should submit its query to by using the drop-down list of databases available to Design Studio.

SQL Query

This field must contain a valid SQL query in the form of an expression. The value of this expression is submitted to the chosen database. The "Edit" popup dialog allows the SQL query to be tested, showing a sample of the output.

Variables Map

Specify the mapping from result columns to variables. Click the plus sign to add a new mapping and the minus sign to remove an existing one. A mapping consists of a column name and a variable name. The column name must match the name of a column returned by the SQL Query, and the variable name is chosen from a list of existing variables. Note, that the type of the column should match the type of the

chosen variable. Otherwise, an error may be generated during execution. That is, trying to store a text column in an integer variable will cause an error.

Retrieve While Looping

If this is enabled, result rows are retrieved from the database only as they are needed by the loop, iteration by iteration. See the note below on execution.

First Row in Design Mode

Used only in Design Mode in Design Studio, this is the number of the first iteration or query result row that will be accessible (counting from 1). See the note below on execution.

Rows to Use in Design Mode

Used only in Design Mode in Design Studio, this specifies the maximum number of result rows to make available for iteration. See the note below on execution.

Note Depending on whether Retrieve While Looping is disabled or enabled, retrieval of the result rows is done in two different ways:

- Disabled: The result rows are all retrieved and saved in memory before the first iteration is executed. Thus, the database connection will be reserved for the shortest possible length of time, and the results will not be affected by any steps that are part of the loop (for example, [Store In Database](#) steps). On the other hand, available memory puts a limit to the number of result rows that can be handled without error. (This was the only option available until release 8.3).
- Enabled: The results rows are retrieved from the database one at a time as they are needed for executing each iteration of the loop. Thus, the step will be able to handle very large numbers of result rows but will hold the database connection open until all iterations of the loop have finished execution. As a side effect, the results may be affected if you make changes to the database tables referenced by the SQL query while the loop executes. However, many factors work together to determine whether the changes will in fact be visible in any particular situation.

In Debug Mode in Design Studio, retrieving while looping implies that the database connection will be held open while execution is stopped at a breakpoint or during single-stepping. If the database has a timeout for inactive connections, you may see a database error when you continue execution of the robot after a long pause.

In Design Mode in Design Studio, result rows will always be retrieved before the loop starts, thus Retrieve While Looping is effectively disabled. This is done to make it possible to switch between different iterations interactively. In order to limit the amount of memory used for this, the First Row in Design Mode and Rows to Use in Design Mode together specify a subset of result rows to load. For example, if

- First Row in Design Mode = 301
- Rows to Use in Design Mode = 100

then the loop will iterate over result rows 301 to 400 (provided the SQL query returns so many rows).

Raw HTTP

The Raw HTTP action sends a HTTP request to a web server. How the response is treated depends on the method, but in general the status code and the response headers are returned in variables defined as part of the page load options.

Properties

The Raw HTTP action can be configured by its properties:

Location

This property specifies which URL to open. The URL can be specified in several ways using a [URL Selector](#).

Method

Here you specify which method to use:

- GET is used for performing a GET HTTP request.
- POST is used for performing a POST HTTP request. For POST requests specify a number of parameters as name/value pairs or give the entire body of the request. If the request is specified with parameters, you must select whether to use POST (application/x-www-form-urlencoded) or MULTIPART (multipart/form-data) to encode the parameters. If the entire ('raw') body of the request is given, the content type of the request data must be specified.
- PUT is used for performing a PUT HTTP request. For PUT requests specify a number of parameters as name/value pairs or give the entire body of the request.

The following settings are common for GET, POST, and PUT requests.

Parameters

Here you can specify a number of parameters as name/value pairs. Click '+' to add a new parameter.

For POST and PUT requests, MULTIPART encoding can be selected to enable file uploads. If a binary variable is selected as the value of a File Upload parameter, the bytes are submitted as-is. If Base 64 encoding is desired, the value of the parameter should be an expression `base64Encode(data)` where data is the name of the variable containing the binary value. In that case, it is also recommended to specify the value base64 as Content Transfer Encoding - otherwise, this field can normally be left blank.

Accept

This is the content types that will be accepted as response. By default, any type of response will be accepted. The accepted content types can be specified in several ways using a Value Selector.

Encoding

This is the encoding that will be used to encode special characters in the request.

Store In

This is the name of a required variable in which to store the result.

- HEAD is used for performing a HEAD HTTP request. Since the HEAD request does not return any data as part of its response (only a status code and the response headers) it uses variables defined as part of the page load options to access this. A GET request can be used to simulate a HEAD request. This will result in a GET HTTP request being sent that will be aborted as soon as the header information is received i.e. the entire response will not be loaded.
- OPTIONS is used for performing an OPTIONS HTTP request. Since the OPTIONS request does not return any data as part of its response (only a status code and the response headers) it uses variables defined as part of the page load options to access this. The response would normally include header fields that indicate optional features implemented by the server and applicable to the requested resource (URL), e.g. Allow: OPTIONS, TRACE, GET, HEAD

Options

The robots options can be overridden with the steps own option. The option that are changed will override the ones from the robots configuration and will be marked with an asterisk in the Options dialog.

Note If additional request headers are needed, this can also be configured under Options.

Refind Object

This step has been deprecated, as it can't be used with the new storage mechanism, described in Storing data in databases

This action attempts to refind an object in storage, e.g. a database. If the object can be refound, then execution along the current branch will stop. Otherwise, extraction will continue past the step containing the Refind Object action. As a result, the Refind Object action is a means to minimize robot execution time.

Properties

The Refind Object action can be configured using the following properties:

Variable

The object which is affected can be selected by choosing one from the Object drop-down box. The objects available in the drop-down box are the configured output objects.

Attributes to use for Refinding

This box is a list of object attributes that will uniquely identify the object in the storage. The Refind Object action will try to find an object in storage that matches with what you have found so far at this point in the robot execution. If such an object exists, there is little point in continuing, as the rest of the fields are probably also correct in storage.

You should try to select as few object attributes as possible, while still maintaining global uniqueness during the entire lifetime of the object.

You should not include object attributes which either are not present in all of the objects or which could change during the lifetime of the object.

Remove Attribute

This action removes an attribute from a tag in XML.

The step action only works on XML variables. Note that this step neither validates the XML nor resolves entities.

Properties

The Remove Attribute action can be configured using the following property:

Attribute Name

The name of the attribute to remove.

Remove Columns

This action removes selected columns from a spreadsheet.

Remove Content

This action remove all the content of a tag. In other words it clears the content of a tag leaving back only the tag itself.

The step action only works on XML variables. Note that this step neither validates the XML nor resolves entities.

Properties

The Remove Content action has no properties.

Remove Cookie

The Remove Cookie action removes one or more cookies from the set of current cookies.

Properties

The Remove Cookie action can be configured using the following properties:

Domain Pattern

Specify a [pattern](#) that matches the domain of the cookie. The pattern must match the entire domain of the cookie.

Path Pattern

Specify a pattern that matches the path of the cookie. The pattern must match the entire path of the cookie.

Name Pattern

Specify a pattern that matches the name of the cookie. The pattern must match the entire name of the cookie.

Value Pattern

Specify a pattern that matches the value of the cookie. The pattern must match the entire value of the cookie.

Example

Consider a cookie named "PREF" having domain ".kapowtech.com", path "/" and value "123". This cookie can be removed by setting Name Pattern to "PREF". However, this will remove *all* cookies named "PREF" regardless of their domain, path or value. So if only this cookie should be removed (assuming that this is the only cookie with this name, domain and path), set Domain Pattern to ".kapowtech.com", Path Pattern to "/", Name Pattern to "PREF" and Value Pattern to "123".

In order to remove all cookies unconditionally, set all patterns to ".*".

Remove JSON

This action removes the found JSON from a JSON value. The the action will either remove a property (name/value pair) from an object, an item from an array or the entire JSON value (in which case the result will be an empty JSON value).

The step action only works on JSON variables.

Properties

The Remove JSON action has no properties.

Remove Rows

This action removes selected rows from a spreadsheet.

Remove Sheet

This action removes a selected sheet from a spreadsheet.

Remove Table Rows

This action will remove all rows (<tr>-tags) in the input <table>-tag that do not have a certain number of columns (<td>- and <th>-tags).

Properties

The Remove Table Rows action can be configured using the following properties:

Min. Number of Columns

Enter the minimum number of columns which should always be in a table row.

Max. Number of Columns

Enter the maximum number of columns which are allowed in a table row.

Any rows that do not have a number of columns that lie in the range [Min. Number of Columns; Max. Number of Columns] will be removed.

If all rows in the table end up being removed, the Remove Table Rows action will generate an error.

Example

Consider the input:

```
<table>
  <tbody>
    <tr><td> 1 </td></tr>
    <tr><td> 2 </td><td> 2 </td></tr>
    <tr><td> 3 </td><td> 3 </td><td> 3 </td></tr>
  </tbody>
</table>
```

Assume that:

- Min. Number of Columns is set to 1
- Max. Number of Columns is set to 2

This setting will remove the last row with the three <td>-tags.

Remove Tag

The Remove Tag action removes the found tag from its parent node.

The step action only works on XML variables. Note that this step neither validates the XML nor resolves entities.

Remove Tag Range

The Remove Tag Range action removes a range of tags, i.e. all tags from one tag to another tag.

Properties

The Remove Tag Range action can be configured using the following properties:

Begin Tag

Specifies the begin tag of the tag range to remove.

Remove Begin Tag

Determines whether or not the begin tag should be removed.

End Tag

Specifies the end tag of the tag range to remove.

Remove End Tag

Determines whether or not the end tag should be removed.

Remove Tags

The Remove Tags action removes tags from the found tags that match the specified criteria, based on two sets of rules.

Set-up

The Remove Tags action is configured by defining a set of rules for tags to remove, and a set of rules to except tags from the deletion rules.

Adding and removing rules from the lists

To add a rule to one of the two lists, click the '+' below the list. Removing a rule is done by selecting the rule in the list, and clicking the '-' below. Reordering of the rules can be done using the arrows below the list. After adding a rule, it can be edited using the 'edit' button below the list.

Note Defining no rules in the list of remove rules, will remove all tags that are not matched by any of the except rules.

The rule editor

On the rule editor, that pops up upon clicking '+' or 'edit' below a list, a choice of three different methods for matching the tags to be either removed or excluded from removal is presented.

The choice is between:

- **Tags with this name** will match all tags with the exact name written in 'Tag Name'.
- **Tags with this name and attribute** will match all tags with the exact name written in 'Tag Name' and matching the criteria for the attributes.
- **Tags matching this pattern** will match a regular expression against the start tags including their attributes (everything between < and >). Tag matching patterns can be inverted to match all tags, that does not match the pattern.
- **Texts matching this pattern** will match a regular expression against the texts inside the found tags. If the regular expression is left empty, it will match all texts.
- **Comments** will match all comments.

Properties for the tag matching methods

The 'include children' option

Checking the 'include children' checkbox (default) means including the children for this rule. For remove rules, this means not only removing the tag (and its corresponding end tag) but also removing all contents of the tag. For except rules, this means keeping also the children (even if any of the children matches a remove rule).

This option is strongest for the except rules. That means, if a tag is matched by one of the remove rules, which is set to include its children, if any of the child tags of that tag matches one of the except rules, the child tag is kept (including its children).

Options for the 'Tags with this name' matching method

Tag Name

Specifies the exact name of the tags matched by this rule.

Options for the 'Tags with this name and attribute' matching method

Tag Name

Specifies the exact name of the tags matched by this rule. This option can be left blank, if tags should only be matched on the attribute criteria.

Attribute Name

Specifies the exact name of the attribute to match.

Attribute Value Pattern

Specifies a [pattern](#) that must match the attribute value of the specified attribute.

Options for the 'Tags matching this pattern' matching method

Tag Name

Specifies the exact name of the tags matched by this rule.

Invert Pattern

Select this option to make the rule match all tags, that do not conform to this pattern.

Options for the 'Texts matching this pattern' matching method.

Pattern

Specifies a pattern that must match the text. Leaving this pattern blank, will make it match all texts.

Options for the 'Comments' matching method.

This method has no options, and will always match all comments. Use tag finders to point out specific comments to be deleted.

Rename File

This action renames a file or a directory on the local file system where the robot is executed.

Note that the action is only performed during execution in Design mode in Design Studio, if the option Execute in Design Mode has been selected.

Properties

The Rename File action can be configured using the following properties:

File or Directory

This is the the system path or a file URL for the file or directory to be renamed. This can be specified in several ways using a [Value Selector](#). The path must be absolute, including the drive name, if any, and the directory path to the directory. Alternative it can be a file URL, such as file:/C:/temp/oldFile.txt, in which case it must be URL encoded. The separators / and \ may be used interchangeably.

New Name

The is the new name of the file or directory. This is actually a relative path so it can be used to move files to a different location by specifying a new name that contains a directory structure, such as ../SomeOtherFolder/newText.txt

Execute in Design Mode

If this is enabled, the action will be executed even in Design Mode inside Design Studio. If this is disabled, the action will do nothing when you navigate the robot in Design Mode.

Repeat

This action creates a repeat loop together with the [Next](#) action.

The Repeat action marks the start of the repeat loop. In a subsequent step, another iteration of the loop can be requested using a Next action. The windows, pages, etc. at the Next step will be sent back to the Repeat step and will become the output from the Repeat step in the next iteration. If no Next step is executed in a given iteration, that iteration will be the last one, and the repeat loop will end.

The Repeat action is particularly useful for looping through pages that are connected with *next-page* links, like this:

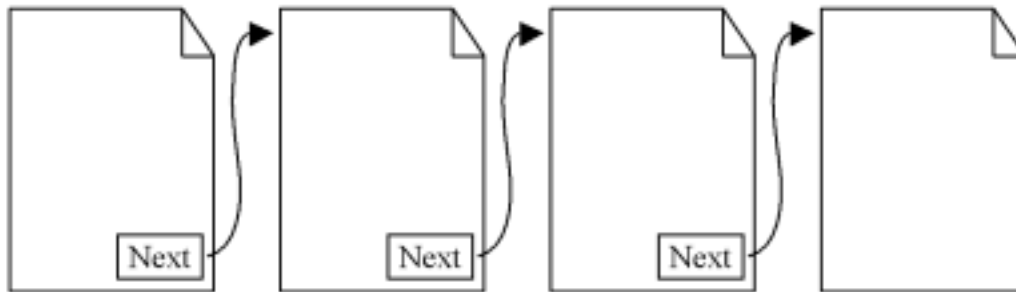

See *Pages where Each Page Links to Next* in the Design Studio section for examples on how to use the Repeat action.

For more information, also see the Repeat-Next tutorial.

Replace Tag

The Replace Tag action replaces the found tag with a new tag. Any JavaScript present in the HTML of the new tag will be executed, unless JavaScript execution is disabled in the [options](#).

Properties

The Replace Tag action can be configured using the following properties:

HTML of New Tag

Specify the HTML of the new tag. The HTML can be specified in a number of ways as described later in this topic.

Options

The robot's options can be overridden with the step's own options. An option that is marked with an asterisk in the Options Dialog will override the one from the robot's configuration. All other options will be the same as specified for the robot.

Specifying the HTML

The HTML of the new tag can be specified in the following ways:

HTML

Simply write the HTML of the new tag.

HTML from Expression

Write an [expression](#) whose result is used as the HTML of the new tag.

HTML from Expression and Pattern

Write a [pattern](#) which is matched against the found tag, and an expression whose result is used as the HTML of the new tag. Use this way of specifying the HTML if parts of the found tag should be used when creating the HTML of the new tag.

Pattern

A pattern which is matched against the found tag for the Replace Tag action. The pattern must match the entire found tag, otherwise an error will be generated.

Match Against

Specifies what the pattern should be matched against from the found tag.

- "Only Text" specifies that the pattern should be matched against only the text in the found tag.
- "HTML" specifies that the pattern should be matched against the HTML of the found tag.

Ignore Case

If this is checked, then the pattern is matched against the input without regard to the character case; e.g. "KaPoW" is considered equal to "kApow".

Expression

This field contains an expression whose result is used as the HTML of the new tag. The expression can refer to the submatches of the pattern in the Pattern field using the \$n notation. For example, you can enter \$1 in the expression to get the first submatch in the pattern (i.e. the text that matches the contents of the first pair of parentheses in the pattern).

HTML Converted from XML Variable

Choose an XML variable whose content will be transformed to HTML and used as the HTML of the new tag.

Use Default Options

If checked, the default options of the robot are used (configured as part of the [robot configuration](#)). Otherwise, the specific options configured in the Options property below are used.

Options

Configure the options to use if the Use Default Options property is not checked.

Restore Session

The Restore Session action restores a session previously saved in a variable by another robot run using the [Save Session](#) action. See the help on Save Session for more information on reusing sessions.

If no session exists with the given parameters (e.g. has not been saved yet), the Restore Session action produces an error.

Properties

The Restore Session action can be configured using the following properties:

Restore From Variable

Select a Session Variable.

Note The Session Pool option has been removed from the step. If an old robot with the Session Pool option is opened, a warning with a tooltip is displayed.

Resume Browser

This action resumes the browser and lets it run after either specified wait criteria are met or the browser becomes idle (whichever comes first).

Specify wait criteria for this step. See [Use Wait Criteria](#) for more information.

Return Value

This action returns a value from the robot.

The value is returned back to the client that initiated this robot run. This would normally be Java or .Net code using the Kapow API to execute robots on RoboServer. The Return Value step action is also used to return values as Kapplet results and REST responses.

Prior to version 7.2 of Kapow the returned value may also be handled by a storage environment, that stored the value in a database. From Kapow version 7.2 and forward, values are stored in databases using the Store in Database action.

Properties

The Return Value action can be configured using the following properties:

Variable

Select the variable whose value should be returned.

If Missing Required Attributes

Here you select what should happen if one or more of the required attributes are missing.

Rewrite Page

The Rewrite Page step action takes the HTML page located in the current window, extracts the HTML content of that page and any frames that it may have and additionally outputs the links to other pages as well as the URLs of images, style sheets and other resources that the page depends on. Later, the page can be viewed offline exactly as it was at the time of the extraction.

All JavaScript and event handlers will be removed from the extracted HTML because the extracted HTML represents the result obtained from having already loaded the page and its frames and executed any JavaScript that could generate additional content. All URLs of the page will be rewritten, first according to a user-specified transformation and then they will be converted relative URLs. URLs in inline style sheets will also be rewritten.

The external style sheets whose URLs are outputted by the step action should be run though the [Rewrite Style Sheet](#) step action which applies a similar transformation; rewriting URLs of imported style sheets and images referenced in the style sheet.

The Rewrite Page step action is intended to be used in robots that have an external controller that feeds URLs of pages, style sheets and other resources to be rewritten into the robot.

Related Step Actions

To create a quick offline snapshot of a page, the [Make Snapshot](#) step action can be used. It does not require that the robot is controlled by an external application but will - in a single step - download and save all necessary resources in the file system, forming a complete, stand-alone snapshot.

Unlike the Rewrite Page step action, the Make Snapshot step action does not preserve links between different snapshots and does not reuse shared resources between snapshots.

Note Execution of this step is controlled by the license key.

Properties

The Rewrite Page step action can be configured using the following properties:

Original Page URL

Specify the variable containing the original URL of the page in the current window. This is the URL that was used to load the page. Note that the current URL of the page may be different if the server redirected to a different page than the one that was requested.

Data Converters

The data converters that specify the transformation to perform on the URLs of the page. This can be used to specify the transformation from URL to a location in the file system. The data converters should output an absolute URL (which may be a file URL), which the step action will automatically convert to a URL that is relative to the original page URL. For advanced URL rewriting, we recommend the Convert Using JavaScript data converter.

Extracted Pages

The variable in which to store the extracted pages. The step action will extract the HTML of the page in the current window as well as HTML for each of the frames. This will be outputted in JSON format, which also contains both the original URL and rewritten URL for each of the pages. Only the main page will however have its original URL specified.

To load the JSON output into a window, use the [Create Page](#) step action with the name of the variable containing the JSON as its source of content. In the [Options](#) of the step, you may need to explicitly specify that the content type is JSON and that the encoding is UTF-8.

URLs

The variable in which to store the extracted URLs. The step action will extract the URLs of all pages, images, style sheets and other resources directly linked to by the page and its frames. Note that the style sheets and pages linked to may themselves contain URLs; these are not included in the list.

The URLs are outputted in JSON format, giving both the original URL as well as the absolute rewritten URL of each URL. Also, the type of URL is given, which is determined by the context in which the URL occurs - for instance, all URLs found in tags are marked with type IMAGE.

The available types are:

PAGE

A link found in an anchor tag. Note that this does not imply anything about the content type of that page, as it has not yet been loaded.

IMAGE

An image.

STYLESHEET

An external CSS style sheet.

RESOURCE

A binary resource, for instance a PDF found in a frame or a Flash object.

To load the JSON output into a window, use the [Create Page](#) step action with the name of the variable containing the JSON as its source of content. In the [Options](#) of the step, you may need to explicitly specify that the content type is JSON and that the encoding is UTF-8.

Rewrite Style Sheet

The Rewrite Style Sheet step action is to be used in conjunction with the [Rewrite Page](#) step action. It rewrites all of the URLs found in a style sheet according to a user-specified transformation and additionally converts them so that they are relative to the style sheet URL.

The Rewrite Style Sheet step action is intended to be applied on the URLs of the external style sheets found by the Rewrite Page step action. It is important that the URL transformation (specified by a list of data converters) of these two step actions are the same.

Note Execution of this step is controlled by the license key.

Properties

Style Sheet URL

The URL of the style sheet to load. If acquired from the output of a Rewrite Page step action, this is found in the originalURL property of an extracted URL of type STYLESHEET.

Data Converters

The data converters that specify the transformation to perform on the URLs of the page. This can be used to specify the transformation from URL to a location in the file system. The data converters should output an absolute URL (which may be a file URL), that the step action will then automatically convert to a URL that is relative to the original page URL. For advanced URL rewriting, we recommend the Convert Using JavaScript data converter. As mentioned above, it is important that the data converters transform URLs in the same way as the [Rewrite Page](#) step action that outputted the style sheet URL.

Output

The variable in which to store the rewritten style sheet.

URLs

The variable in which to store the extracted URLs. The step action will extract the URLs of all images and imported style sheets directly referenced by the loaded style sheet. Note that the imported style sheets may themselves contain URLs; these are not included in the list.

The URLs are outputted in JSON format, giving both the original URL as well as the absolute rewritten URL of each URL. Also, the type of URL is given, which is determined by the context in which the URL occurs - for instance, all URLs found in import statements are marked with type STYLESHEET.

The available types are:

IMAGE

An image.

STYLESHEET

An imported CSS style sheet.

To load the JSON output into a window, use the [Open Variable](#) step action with the name of the variable containing the JSON as its source of content. In the [Options](#) of the step, you may need to explicitly specify that the content type is JSON and that the encoding is UTF-8.

Options

The robot's [loading options](#) can be overridden with the step's own options. An option that is marked with an asterisk in the Options window will override the one from the robot's configuration. All other options will be the same as specified for the robot.

Save Session

The Save Session action saves a browser session. To transfer a session between robots, the variable containing the session can be stored in a database and restored by other robots reading it from the database. If you have a solution utilizing Kapow API, you can have the session as an output from the robot and then use it as an input for another robot.

By default the complete browser state is saved. If this requires too much space, a partial state can be saved consisting of the page, the page URL and the associated cookies and authentications.

The session is stored in a variable and can be later restored by another robot run using the [Restore Session](#) action.

Properties

The Save Session action can be configured using the following properties:

Save Where

Variable

Select a Session Variable.

Note The Session Pool option has been removed from the step. If an old robot with the Session Pool option is opened, a warning with a tooltip is displayed.

Save Complete Browser State

Choose whether to save the complete browser state, or only a partial state consisting of the page, the page URL and the associated cookies and authentications.

Scroll

This action emulates scrolling a page or tag. It is particularly useful on sites where the full contents does not appear until the page or content tag has been scrolled. Note that the scroll step does not change the position of scroll bars in the browser view.

Most commonly, the Scroll step action is used to scroll an entire document, in which no tag finder should be added to the step. To scroll a particular tag that has its own scroll bar, add a tag finder that selects that tag.

Properties

The Scroll action can be configured using the following properties:

Horizontal Scroll

Specify the number of pixels to scroll to the right, relative to the current scroll position. Specify a negative number to scroll to the left. The value can be specified in several ways using a [Value Selector](#).

Vertical Scroll

Specify the number of pixels to scroll down, relative to the current scroll position. Specify a negative number to scroll up. The value can be specified in several ways using a Value Selector.

Options

The robot's [options](#) can be overridden with the step's own options. An option that is marked with an asterisk in the Options Dialog will override the one from the robot's configuration. All other options will be the same as specified for the robot.

Scroll To

This action scrolls the found tag into view. It is particularly useful on sites where the full contents - including images - only appear when a specific area of the page would be visible to the user interacting with the browser.

Properties

The Scroll To action can be configured using the following properties:

Options

The robot's [options](#) can be overridden with the step's own options. An option that is marked with an asterisk in the Options Dialog will override the one from the robot's configuration. All other options will be the same as specified for the robot.

Select File

This action selects a file to upload in a file field.

The found tag must be the <input>-tag of type file.

Properties

The Select File action can be configured using the following properties:

File to Select

Specifies the file to upload. The file must be obtained from one of the following locations:

File Contained in Variable

The file contents is read from a variable.

File Name

Specify the file name. The value can be specified in several ways using a Value Selector.

File Content Type

Specify the content type of the file. See below how it may be specified.

File Contents

Select the variable that holds the contents of the file.

File in Local File System

The file is located in the local file system.

File Name

Specify the file name. The value can be specified in several ways using a Value Selector.

File Content Type

Specify the content type of the file. See below how it may be specified.

Options

The robot's [options](#) can be overridden with the step's own options. An option that is marked with an asterisk in the Options Dialog will override the one from the robot's configuration. All other options will be the same as specified for the robot.

Specifying the File Content Type

The file content type can be specified in the following ways:

Automatic

The content type will be automatically determined from the content.

From Variable

The content type is specified by a variable in an object. For example, the variable should contain the text "image/gif" for a GIF image.

Predefined

The content type is selected from a list.

Custom

The content type is specified directly, e.g. "text/plain" for text contents.

Select Multiple Options

This action selects multiple options in a list box.

The found tag must be a <select>-tag with multi-selection enabled, i.e. with a "multiple" attribute present.

Note that selecting the options may trigger execution of JavaScript, if there are any registered event handlers on the <select>-tag.

To select a single option in a drop-down box or list box, use the [Select Option](#) action. To loop through options, use the [For Each Option](#) action.

Properties

The Select Multiple Options action can be configured using the following properties:

Options to Select

The options to select. You may either select ALL options or specify exactly the options to select. The list of options may be left empty to not select any options.

Keep Existing Selections

Specifies whether existing selections in the list box should be kept. If this is not selected, and if no options have been selected in the Options to Select property, all existing selections in the list box will be unselected, and no new selections will be made.

Options

The robot's [options](#) can be overridden with the step's own options. An option that is marked with an asterisk in the Options Dialog will override the one from the robot's configuration. All other options will be the same as specified for the robot.

Select Option

This action selects an option in a drop-down box or a list box.

The found tag must be the <select>-tag of the drop-down/list box, *not* the <option>-tag for the option to select.

Note that selecting the option may trigger execution of JavaScript, if there are any registered event handlers on the <select>-tag.

To select multiple options at the same time in a list box, use the [Select Multiple Options](#) action. To loop through options, use the [For Each Option](#) action.

Properties

The Select Option action can be configured using the following properties:

Option to Select

The option to select. This can be specified in several ways using a [Value Selector](#). Note that this value must correspond to an <option>-tag inside the <select>-tag, and that it may match either the value as

it appears in the form, or the value shown for the option in the drop-down/list box. More specifically, the matching is done as follows:

- If the value exactly matches the "value" attribute of an <option>-tag, the first such <option>-tag is selected.
- Otherwise, if the value matches the "value" attribute of an <option>-tag without regard for leading or trailing space characters, the first such <option>-tag is selected.
- Otherwise, if the value matches the text inside an <option>-tag without regard for leading or trailing space characters, the first such <option>-tag is selected.

Ignore Case

When checked, matching of the option value is done case-insensitively.

Options

The robot's [options](#) can be overridden with the step's own options. An option that is marked with an asterisk in the Options Dialog will override the one from the robot's configuration. All other options will be the same as specified for the robot.

Select Radio Button

This action selects a radio button, thereby unselecting any other radio buttons in the same radio button group.

The found tag must be an <input>-tag of type radio button.

Note that selecting the radio button may trigger execution of JavaScript, if there are any registered event handlers on the radio buttons in that radio button group.

To loop through the radio buttons in a group, use the [For Each Radio Button](#) action.

Properties

The Select Radio Button action can be configured using the following properties:

Options

The robot's [options](#) can be overridden with the step's own options. An option that is marked with an asterisk in the Options Dialog will override the one from the robot's configuration. All other options will be the same as specified for the robot.

Send Email

The Send Email action sends an email.

Note The email is not sent during execution in Design mode in Design Studio.

Properties

The Send Email action can be configured using the following properties:

Message Tab

This tab contains the properties that allow you to specify the message content, sender and receiver.

FROM Address

Specifies the FROM Address (sender address) of the email. The value can be specified in several ways using a [Value Selector](#).

TO Address

Specifies the TO Addresses (receiver addresses) of the email. At least one To Address must be specified and if there are more than one address these has to be separated by commas. The value can be specified in several ways using a Value Selector.

CC Address

Specifies the CC Addresses (receiver addresses) of the email. These addresses are optional, but if more than one address is specified the addresses has to be separated by commas. The value can be specified in several ways using a Value Selector.

Subject

Specifies the subject of the email. The value can be specified in several ways using a Value Selector.

Message

Specifies the message body of the email. The value can be specified in several ways using a Value Selector.

Message Type

Specifies the type of the message body, either text or HTML.

Server Tab

This tab contains the properties that allow you to configure the mail server to use.

Mail Server

Specifies the mail server to be used when sending the email. The value can be specified in several ways using a [Value Selector](#).

Port

Specifies the port number on the mail server to be used when sending the email. The appropriate port number is most often 25 when SSL is not used, and 465 when using SSL. The value can be specified in several ways using a Value Selector.

User

Specifies the user name to be used for authentication when sending the email. If left empty, authentication is not done. The value can be specified in several ways using a Value Selector.

Password

Specifies the password to be used for authentication when sending the email. The value can be specified in several ways using a Value Selector.

Encryption

Specifies if encryption should be used.

- NONE: Credentials and email are sent in clear text.
- TLS: TLS encryption is used. After connection the STARTTLS command is used to upgrade the communication channel to TLS. This only works if the SMTP server has a trusted certificate (if the

server uses a self-signed certificate it must be exported and imported into the JVM's truststore using the keytool utility)

- SMTPS: SMTP over SSL. A secure channel of communication is established, over which the credentials and email is sent. This is rarely supported by SMTP servers, but will work even if the servers certificate is self-signed.

Attachment Tab

This tab contains the properties that allow you to add an attachment to the e-mail.

Include Attachment

To add an attachment to the message, check this option.

Content

The content of the attachment to include. The value can be specified in several ways using a [Value Selector](#).

Content Type

Specifies the type of the attachment. If you select "Automatic", the type will be determined from the extension of the given file name.

File Name

Specifies the type of the attachment. If you do not specify one, a default name will be generated.

Set Attribute

This action inserts or updates an attribute on the found tag with a specified name and value. If the found tag contain an attribute with the given name its value is updated with the specified value otherwise a new attribute is inserted with the value specified.

The step action only works on XML variables. Note that this step neither validates the XML nor resolves entities.

Properties

The Set Attribute action can be configured using the following properties:

Attribute Name

The name of the attribute to set or update.

Value

The value of the attribute. This will be correctly encoded according the rules for encoding attribute values in the given type of document, e.g. XML.

Set Checkbox

This action checks or clears a checkbox.

The found tag must be an <input>-tag of type checkbox.

Note that setting the checkbox may trigger execution of JavaScript, if there are any registered event handlers on the checkbox.

Properties

The Set Checkbox action can be configured using the following properties:

Set Checkbox to

Specifies the state that the checkbox should be set to, i.e. checked or cleared. The state is specified using a Value Selector. The resulting value must be either "true", "on", "1", or "checked" to check the checkbox, and either "false", "off", "0", or "unchecked" to clear the checkbox.

Options

The robot's [options](#) can be overridden with the step's own options. An option that is marked with an asterisk in the Options Dialog will override the one from the robot's configuration. All other options will be the same as specified for the robot.

Set Column Width

This action sets the width of a column in a spreadsheet. The width is specified in a number of characters.

Properties

The Set Column Width action can be configured using the following properties:

Width

This property specifies the width of a column. Options are:

- Value - Sets the value directly
- Variable - Specifies a variable that stores the width value.
- Expression - Creates an expression to specify the width.
- Converters - Specifies a data converter to set the column width.

Set Content

This action sets the specified content on a tag.

The step action only works on XML variables. Note that this step neither validates the XML nor resolves entities.

Properties

The Set Content action can be configured using the following properties:

Content Modification Mode

This property specifies which tag to modify. You can select from **Set Existing Tag** and **Set Root Tag** options.

New Content

The new content to insert.

Set Content of Cell

This action inserts the specified content to a spreadsheet cell.

Properties

The Set Content of Cell action can be configured using the following properties:

Content

This property specifies the content of a cell. Options are:

- Value - Sets the value directly
- Variable - Specifies a variable that stores the value.
- Expression - Creates an [expression](#) to specify the value.
- Converters - Specifies a [data converter](#) to set the value.

Format

This property specifies the format of a cell. Options are:

- Value - Sets a value directly
- Variable - Specifies a variable that stores the value.
- Expression - Creates an [expression](#) to specify the value.
- Converters - Specifies a [data converter](#) to set the value.

Set Content of Column

This action sets the content of a column in a spreadsheet from a variable of complex type. The attribute values of the variable is inserted consecutively beneath each other starting from the first cell of the found range.

Properties

The Set Content of Column action can be configured using the following properties:

Variable

This property specifies the name of a variable that stores the cell values.

Date Format

If any of the inserted cell values is a date then this property may be used to specify the date format of the cell. Options are:

- Value - Sets the format directly
- Variable - Specifies a variable that stores the format.
- Expression - Creates an [expression](#) to specify the format.
- Converters - Specifies a [data converter](#) to set the format.

Set Content of Row

This action sets the content of a row in a spreadsheet from a variable of complex type.

Properties

The Set Content of Row action can be configured using the following properties:

Variable

This property specifies the name of a variable that stores the row values.

Date Format

If any of the inserted cell values is a date then this property may be used to specify the date format of the cell. Options are:

- Value - Sets the format directly
- Variable - Specifies a variable that stores the format.
- Expression - Creates an [expression](#) to specify the format.
- Converters - Specifies a [data converter](#) to set the format.

Set Current Window

This action selects another [window](#) as the current window, i.e. the window that subsequent steps will work on.

In Design Studio, an easy way to insert a Set Current Window step is to right-click on the window's tab and choose Set as Current Window.

Properties

The Set Current Window action can be configured using the following properties:

Window to Set as Current

The window that should be selected as the current window (see [Identifying a Window](#) on how to identify a window).

You can use the following options to set a current window:

- **Window Name:** finds a window by its name as displayed in the window's tab
- **Window in Found Tag:** this option makes the window created by the found tag as the one to make current. The found tag must be a FRAME, IFRAME, OBJECT or EMBED element.

Set Format of Cells

This action sets the format of one or more cells in a spreadsheet.

Properties

The Set Format of Cell action can be configured using the following properties:

Format

The format of the data to insert. Options are:

- Value - Sets the format directly
- Variable - Specifies a variable that stores the format.
- Expression - Creates an [expression](#) to specify the format.
- Converters - Specifies a [data converter](#) to set the format.

Set Hyperlink on Cell

This action inserts a hyperlink to a cell.

Properties

The Set Hyperlink on Cell action can be configured using the following properties:

URL

This property specifies the address of a link. Options are:

- Value - Sets the link address directly
- Variable - Specifies a variable that stores the link address.
- Expression - Creates an [expression](#) to specify the link address.
- Converters - Specifies a [data converter](#) to set the link address.

Use default link style

This property specifies whether the default style for link should be set on the cell, i.e. text is underlined and has blue foreground color.

Set Information Property

This action sets the value of an information property in a spreadsheet.

Properties

The Set Information action can be configured using the following properties:

Name

This property specifies the name of the information property.

Value

This property specifies the content of the value. Options are:

- Value - Sets the value directly
- Variable - Specifies a variable that stores the value.
- Expression - Creates an [expression](#) to specify the value.
- Converters - Specifies a [data converter](#) to set the value.

Set JSON

This step action replace the entire found part of a JSON value with a new JSON value. The new value must be a valid JSON value, such as an object { "answer" : 42 } or a quoted string "Life, the Universe and Everything".

The step action only works on JSON variables.

Properties

The Set JSON action can be configured using the following properties:

New Content

The new JSON value.

The value can be specified in several ways using an extended version of the Value Selector. This value selector contains the usual 4 ways to specify the value and an extra very useful selector: Generate From Variable. This selector automatically generates JSON from a variable of complex type. E.g. if you have a variable with a type that has two attributes: name and age and the values of these are "Joe" and 23 then the generated JSON could look like: { "name" : "Joe", "age" : 23 }.

Set Named JSON

This action marks the found JSON as a [named JSON](#), so that it can be used as a reference when finding other parts of a JSON value in subsequent steps.

This is useful if several steps should work relative to this.

Properties

The Set Named JSON action can be configured using the following properties:

Name

Has two options, **Auto** or **Named**. Auto gives the item a name which is number. The first Auto-numbered item will have number 1, the next number 2 etc. Note that the number may change if additional Auto-numbered items are inserted before this step (on the same page). Named gives the item a fixed and explicitly stated name, which has several advantages:

- It is easier to remember what the named item identifies if it has a well-chosen name
- An explicitly named item is not affected if another named item is inserted before it
- If you use the same name again in Set Named JSON, the name will simply be made to refer to the new item (useful for stateful in-page looping)

Keep Existing Named Items

If checked, the existing named items will be kept, otherwise these will be unmarked as named items and only the found item will be a named item after this step.

Set Named Range

This action marks the found range as a **named range**, so that it can be used as a reference when finding ranges in subsequent steps.

This is useful if several steps should work relative to this range.

Properties

The Set Named Range action can be configured using the following properties:

Range Name

Has two options, **Auto** or **Named**. Auto gives the range a name which is number. The first Auto-numbered range will have number 1, the next number 2 etc. Note that the number may change if additional Auto-numbered ranges are inserted before this step (on the same page). Named gives the range a fixed and explicitly stated name, which has several advantages:

- It is easier to remember what the named range identifies if it has a well-chosen name
- An explicitly named range is not affected if another named range is inserted before it
- If you use the same name again in Set Named Range, the name will simply be made to refer to the new range (useful for stateful in-page looping)

Keep Existing Named Ranges

If checked, the existing named ranges will be kept, otherwise these will be unmarked as named ranges and only the found range will be a named range after this step.

Set Named Tag

This action marks the found tag as a named tag, so that it can be used as a reference when finding tags in subsequent steps.

This is useful if several steps should work relative to this tag.

Properties

The Set Named Tag action can be configured using the following properties:

Tag Name

Has two options, **Auto** or **Named**. Auto gives the tag a name which is number. The first Auto-numbered tag will have number 1, the next number 2 etc. Note that the number may change if additional Auto-numbered tags are inserted before this step (on the same page). Named gives the tag a fixed and explicitly stated name, which has several advantages:

- It is easier to remember what the named tag identifies if it has a well-chosen name
- An explicitly named tag is not affected if another named tag is inserted before it
- If you use the same name again in Set Named Tag, the name will simply be made to refer to the new tag (useful for stateful in-page looping)

Keep Existing Named Tags

If checked, the existing named tags will be kept, otherwise these will be unmarked as named tags and only the found tag will be a named tag after this step.

Set Property Name

This action replaces the property name of the found JSON object with a new name. The value of the property remains unchanged.

The step action only works on JSON variables.

Properties

The Set Property Name action can be configured using the following properties:

Name

The new name of the property. This must of course be a valid property name, e.g. quotation marks should be escaped.

Set Row Height

This action sets the height of a row in points.

Properties

The Set Content action can be configured using the following properties:

Height

This property specifies the height of a row. Options are:

- Value - Sets the row height directly
- Variable - Specifies a variable that stores the row height.
- Expression - Creates an [expression](#) to specify the row height.
- Converters - Specifies a [data converter](#) to set the row height.

Set Sheet Name

This action sets the sheet name.

Properties

The Set Content action can be configured using the following properties:

Name

This property specifies the name of a sheet. Options are:

- Value - Sets the name directly
- Variable - Specifies a variable that stores the name.

- Expression - Creates an [expression](#) to specify the name.
- Converters - Specifies a [data converter](#) to set the name.

Set Tag

This step action replace the entire found tag with new content. The step action is similar to the Set Content step action, but where the later only replaces the content of the tag the Set Tag step action also replaces the tag it self.

The step action only works on XML variables. Note that this step neither validates the XML nor resolves entities.

Properties

The Set Tag action can be configured using the following properties:

New Content

The new content for the entire tag.

Set Tag Name

This action replaces the name of the found tag with a new name and optionally copies the attributes of the found tag to the new tag. The child nodes of the tag are preserved.

The step action only works on XML variables. Note that this step neither validates the XML nor resolves entities.

Properties

The Set Tag Name action can be configured using the following properties:

Content Modification Mode

This property specifies the mode in which to modify the source.

Tag Name

The new name of the tag. This must of course be a valid tag name for the given document type.

Clear Attributes

If the property is set then all the attributes of the found tag are removed. If not then the attributes are copied to the new tag.

Set Text

This step action replace the content of the found tag with a text. The step action is similar to the Set Content step action, but where the later insert the given text as markup, the Set Text step action insert the text either ampersand encoded or as CDATA.

The step action only works on XML variables. Note that this step neither validates the XML nor resolves entities.

Properties

The Set Text action can be configured using the following properties:

Text

The text to insert.

Encoding

The way the text should be encoded. There are two choices:

- "Ampersand" specifies that the text should be ampersand encode when inserted, e.g. < becomes <.
- "CDATA" specifies that the text should be placed in a CDATA section.

Set Value of Cell

This action sets the value of a cell.

Properties

The Set Value of Cell action can be configured using the following properties:

Type

This property specifies the type of the value. Options are:

- Text
- Number
- Logical
- Date
- Formula

Value

This property specifies the content of the value. Options are:

- Value - Sets the value directly
- Variable - Specifies a variable that stores the value.
- Expression - Creates an [expression](#) to specify the value.
- Converters - Specifies a [data converter](#) to set the value.

Format

This property specifies the format of a cell. Options are:

- Value - Sets a format directly
- Variable - Specifies a variable that stores the format.
- Expression - Creates an [expression](#) to specify the format.
- Converters - Specifies a [data converter](#) to set the format.

Snippet Step

The Snippet step is used to insert a Snippet into a robot. A snippet is a sub-part of a robot that may be reused several times either in one robot or across robots. Snippets consists of two parts: a number of connected steps and a set of variables. When a snippet is inserted into a robot via a Snippet step the steps of the snippet is inserted at its location and the variables of the snippet is added to the variables of the robot.

Snippet steps are similar to [Group steps](#). Just as Group steps Snippet steps contain an expand/collapse icon (+/-) located at the top left corner. Clicking on this will expand/collapse the snippet step and like group steps the inserted steps must be such that they have one entry point and one exit point. But unlike group steps, if the steps inside a Snippet step are modified then the corresponding snippet is changed and all other Snippet steps referring to the snippet will change their contained steps.

Please see the introduction to Snippets tutorial for more information.

Properties

The Snippet step is configured using the following properties:

Step Name

This is an optional name for the step. If you enter value for this then this is what is shown in the Robot View below the step. If no step name is provided then the snippet's name is shown instead. When this is the case the name is shown underlined.

Step Comment

This is a comment describing the snippet step. This is not a comment describing the snippet itself, which should be edited directly on the snippet when this is open in an editor.

Snippet

This is the name of the snippet. This refers to a snippet of that name inside the same project as the robot containing the Snippet step. By selecting a different name from the choice box then a new snippet is inserted at the snippet step's location. If the snippet has a comment then this is shown under the choice box.

Stop

This action causes the execution of the robot to stop without errors. That is, none of the remaining iterations, branches or steps in the robot are executed.

Store In Database

This step provides the opportunity to store a variable in a database. The database connection must be configured in Design Studio Settings.

Please read the section on [Storing Data in Databases](#) before using this step in a robot.

Properties

Store in Database can be configured using the following properties:

Database

Controls which database the variable will be stored in. A value can either be selected or hard coded at design time, or the database name can be dynamically constructed at runtime using a variable, an expression or converters - An error will occur if no database with this name exists when the robot is executed.

Variable

Select the variable to store. This must be a regular variable and not a simple type variable.

Key

The unique key for the variable which is stored. The key may be defined in the type (by marking variables as "Part of Database Key"), or defined using a variable, an expression or converters. If a value with the given key already exists, this step will override (SQL Update) the existing record; if no value with this key exists, a new record will be inserted.

Execute in Design Mode

If this is enabled, the step will be executed even in Design Mode inside Design Studio. If this is disabled, the step will do nothing when you navigate the robot in Design Mode.

Store in HBase Table

This step provides the opportunity to store a variable in a HBase Table. The connection settings are configured in the step.

The description below assumes that the general architecture of the HBase cluster is understood. See the notes below for a description of how the data is inserted into the HBase Table.

Properties

Store in HBase Table is configured using the following properties:

ZooKeeper Quorum Hostnames

The list of hostnames used for connecting to the underlying ZooKeeper Quorum that directs access to HBase. The Quorum should give access to a HBase master holding the table the variable will be stored in. A value can either be selected or hard coded at design time, or the list can be dynamically constructed at runtime using a variable, an expression or converters - An error will occur if no database with this name exists when the robot is executed.

HBase Table

Controls which HBase table the variable will be stored in. A value can either be selected or hard coded at design time, or the table name can be dynamically constructed at runtime using a variable, an expression or converters - An error will occur if no database with this name exists when the robot is executed.

Column Family

Controls which column family the variable will be stored in. A value can either be selected or hard coded at design time, or the column family name can be dynamically constructed at runtime using a variable,

an expression or converters - An error will occur if no database with this name exists when the robot is executed.

Variable

Select the variable to store. This must be a regular variable and not a simple type variable.

Key

The unique key for the variable which is stored. The key may be defined in the type (by marking variables as "Part of Database Key"), or defined using a variable, an expression or converters. If a value with the given key already exists, this step will update the existing record; if no value with this key exists, a new record will be inserted. See note below for important information on the key.

Execute in Design Mode

If this is enabled, the step will be executed even in Design Mode inside Design Studio. If this is disabled, the step will do nothing when you navigate the robot in Design Mode.

Note

As all data (including keys and column names) stored by HBase are arrays of bytes, Design Studio will convert all data to byte arrays using UTF-8 encoding before inserting into the table.

The variable data is written to the row with the key specified in the attribute key. If the key is set to be composed of the attributes marked as "Part of Database Key", the key is the concatenation of the value of those attributes separated by underscores (and ordered as in the type editor). For example, if writing a variable of type Company with two ordered attributes marked "Part of Database Key":

- Name = Kapow
- Year = 1999

the resulting key is Kapow_1999. Note that if choosing a binary attribute as part of the key, a hash of the value will be used instead of the actual value. Furthermore, an underscore present in the attribute values used as "Part of Database Key" will be replaced by double underscores.

Writing data to the HBase table is done by putting the value of each attribute in a column having the same qualifier as the name of the attribute. The columns are located in the column family specified. All data in the variable, including the attributes selected to be "Part of Database Key" is written to each row. The two house-hold fields RobotName and ExecutionId described in the section on [Storing Data in Databases](#) are updated in the table every time the step is executed. The remaining five house-hold fields from that page are not stored in the table. No specific timestamp is chosen for the write, it is up to HBase to choose a reasonable value. Using the example from above and Column Family = cf, the data inserted is (ignoring the timestamp): Kapow_1999 => [cf:Name = Kapow, cf:Year = 1999, cf:RobotName = XXXX, cf:ExecutionId = YYYY]

Test Cell Type

This action tests the type of a cell or cells. The types are the data types of Excel: Text, Number, Logical (boolean), Blank, Error, Formula. These essentially corresponds to the Excel functions ISTEXT, ISNUMBER, etc. If more than one cell is selected by the Range Finder, then all the found cells must satisfy the condition of the test.

Properties

The Test Cell Type action is configured using the following properties:

Condition

This contains the condition that must hold. There are 6 possibilities for this:

Is Blank

This is true if and only if the found cells are blank. This corresponds to the Excel function ISBLANK.

Is Text

This is true if and only if the found cells all contains text. This corresponds to the Excel function ISTEXT.

Is Number

This is true if and only if the found cells all contains numbers. This corresponds to the Excel function ISNUMBER.

Is Logical

This is true if and only if the found cells all contains boolean. This corresponds to the Excel function ISLOGICAL.

Is Error

This is true if and only if the found cells all contains errors. This corresponds to the Excel function ISERROR.

Is Formula

This is true if and only if the found cells all contains formulas. this corresponds to the Excel function ISFORMULA.

If

Specifies the exact condition to test for, and thus enables inversion of the stated condition. The default is to test if the "Condition is Not Satisfied". If this is selected and the condition evaluates to false, execution will be affected as indicated by the Do property; however if the condition evaluates to true, execution will continue down the current branch. It is possible instead to test if the "Condition is Satisfied", which reverses the outcome.

Do

Determines what happens when the condition and the If property together indicate that execution should not continue down the current branch.

As Specified Under Error Handling

The [Error Handling](#) tab specifies in detail what to do.

Skip Following Steps

Execution down the current branch will stop.

Test File Existence

This action tests whether a specific file exists, to determine whether execution should continue down the current branch or if something else should be done.

Properties

The Test File Existence action can be configured using the following properties:

File Name

The name of the file to look for. The name can be specified in several ways using a Value Selector. The name must be an absolute file name, including the drive name, if any, and the directory path to the file.

If

Specifies the exact condition to test for, either that the "File Exists" or that the "File Does Not Exist". If this condition is satisfied, execution will be affected as indicated by the Do property; if the condition is not satisfied, execution will continue down the current branch.

Do

Determines what happens when the condition and the If property together indicate that execution should not continue down the current branch.

As Specified Under Error Handling

The [Error Handling](#) tab specifies in detail what to do.

Skip Following Steps

Execution down the current branch will stop.

Test JSON Type

This action tests the type of a JSON value. The types are: Object, Array, String, Integer, Float, Boolean and Null. Besides these it is also possible to test for two more general types: Basic and Number.

Properties

The Test JSON Type action is configured using the following properties:

Condition

This contains the condition that must hold. There are 9 possibilities for this:

Is Object

This is true if and only if the found JSON value is an object. This is a JSON value of the form {...}. It is not equivalent to the JavaScript typeof operation which may also return object for an array since this is considered an object in JavaScript.

Is Array

This is true if and only if the found is an Array. This is a JSON value of the form [...].

Is Simple

This is true if and only if the found JSON value is a Simple type. A Simple type is any JSON value that is not an object or an array.

Is Integer

This is true if and only if the found JSON value is a Integer. This type is an arbitrary-precision integer, but be you should be careful whenever you convert a JSON integer value to some other representation of integers, e.g. in a integer variable, that this may result in overflow.

Is Float

This is true if and only if the found JSON value is a Float. This type is an arbitrary-precision number that is not an integer, e.g. 23.345E-42, but be you should be careful whenever you convert a JSON float value to some other number representation, e.g. in a number variable, that this may result in overflow.

Is Number

This is true if and only if the found JSON value is an Integer or a Float.

Is String

This is true if and only if the found JSON value is a String. A string must begin and end with a quotation marks ("), and various characters must be escaped with backslash (\), e.g. ", \, /, b, f, n, r, t, uXXXX, and so on.

Is Boolean

This is true if and only if the found JSON value is a Boolean. That is, oner of the two value true or false.

Is Null

This is true if and only if the found JSON value is the value null.

Note These condition are not mutually exclusive, such as "Is Number" and "Is Integer" are both true for integer values

If

Specifies the exact condition to test for, and thus enables inversion of the stated condition. The default is to test if the "Condition is Not Satisfied". If this is selected and the condition evaluates to false, execution will be affected as indicated by the Do property; however if the condition evaluates to true, execution will continue down the current branch. It is possible instead to test if the "Condition is Satisfied", which reverses the outcome.

Do

Determines what happens when the condition and the If property together indicate that execution should not continue down the current branch.

As Specified Under Error Handling

The [Error Handling](#) tab specifies in detail what to do.

Skip Following Steps

Execution down the current branch will stop.

Test Page Type

This action test the type of the page in the current window. There are currently 4 page types: HTML, XML, Excel and Binary.

Properties

The Test Page Type action is configured using the following properties:

Page Type

This contains the page type to test for. There are 4 possibilities for this:

HTML

This is true if and only if the page in the current window is an HTML page. This does not necessarily mean that the source was HTML, but only that after the page has been loaded it was passed or converted to an HTML page and presented as such in the Page View.

XML

This is true if and only if the page in the current window is an XML page.

Excel

This is true if and only if the page in the current window is a spreadsheet document.

Binary

This is true if and only if the page in the current window is a Binary page.

If

Specifies the exact condition to test for, and thus enables inversion of the stated condition. The default is to test if the "Condition is Not Satisfied". If this is selected and the condition evaluates to false, execution will be affected as indicated by the Do property; however if the condition evaluates to true, execution will continue down the current branch. It is possible instead to test if the "Condition is Satisfied", which reverses the outcome.

Do

Determines what happens when the condition and the If property together indicate that execution should not continue down the current branch.

As Specified Under Error Handling

The [Error Handling](#) tab specifies in detail what to do.

Skip Following Steps

Execution down the current branch will stop.

Test Row

The Test Row action tests the number of columns in a table row.

The found tag must be a <tr>-tag. Specify an interval defined by the Minimum Number of Columns and Maximum Number of Columns and choose what to do if the number of columns is outside (or inside) the specified interval.

Properties

The Test Row action can be configured using the following properties:

Minimum Number of Columns

Enter the minimum number of columns in a table row.

Maximum Number of Columns

Enter the maximum number of columns in a table row.

If

Specify the exact condition to test for, either that the "Row Matches" or that the "Row Does Not Match" the interval. The row matches the interval if the number of columns in the row is within the specified limits. If the stated condition is satisfied, execution will be affected as indicated by the Do property; if the condition is not satisfied, execution will continue down the current branch.

Do

Determines what happens when the condition and the If property together indicate that execution should not continue down the current branch.

As Specified Under Error Handling

The [Error Handling](#) tab specifies in detail what to do.

Skip Following Steps

Execution down the current branch will stop.

Test Tag

The Test Tag action makes a test to determine whether execution should be allowed to continue down the current branch or if something else should be done. The test consists of matching the found tag against a [pattern](#).

Using a Test Tag action is the most common way of getting conditional execution in a robot.

Properties

The Test Tag action can be configured using the following properties:

Pattern

The pattern to match against the found tag. The pattern must match the entire found tag.

Match Against

Specifies what the pattern should be matched against from the found tag.

- **Only Text** specifies that the pattern should be matched against only the text in the found tag.
- **HTML** specifies that the pattern should be matched against the HTML of the found tag.

Ignore Case

If checked, the pattern matching will be case insensitive.

If

Specifies the exact condition to test for, either that the "Pattern Matches Found Tag" or that the "Pattern Does Not Match Found Tag". If this condition is satisfied, execution will be affected as indicated by the Do property; if the condition is not satisfied, execution will continue down the current branch.

Do

Determines what happens when the condition and the If property together indicate that execution should not continue down the current branch.

As Specified Under Error Handling

The [Error Handling](#) tab specifies in detail what to do.

Skip Following Steps

Execution down the current branch will stop.

Converters

These [data converters](#) (if any are selected) are applied to the text or HTML of the found tag *before* the pattern matching. If the data converters fail to produce any output, an error will be generated.

Test URL

This action tests the URL contained in the found tag, to determine whether execution should continue down the current branch or if something else should be done.

The URL must be contained in a tag of one of the following types:

- ``
- `<area href="URL">`
- `<frame src="URL">`
- `<iframe src="URL">`
- `<script src="URL">`
- `<param value="URL">`
- `<meta http-equiv="Refresh" content="...; url=URL">`

Properties

The Test URL action can be configured using the following properties:

URL Pattern

The pattern which the URL in the found tag should match. The pattern must match the entire URL.

If

Specifies the exact condition to test for, either that the "Pattern Matches URL" or that the "Pattern Does Not Match URL". If the stated condition is satisfied, execution will be affected as indicated by the Do property; if the condition is not satisfied, execution will continue down the current branch.

Do

Determines what happens when the condition and the If property together indicate that execution should not continue down the current branch.

As Specified Under Error Handling

The [Error Handling](#) tab specifies in detail what to do.

Skip Following Steps

Execution down the current branch will stop.

Test Value

This action tests a Boolean value to determine whether execution should continue down the current branch or if something else should be done. The action is among other things useful if the value of

a global variable should be checked. For example, the action can be used to check if a counter has exceeded a given value.

Properties

The Test Value action is configured using the following properties:

Condition

Contains the condition. The condition must evaluate to either true or false. Any other value will produce an error when the action is executed. The default way of specifying the condition is by entering an [expression](#). However, one the other options of the [Value Selector](#) can also be used.

If

Specifies the exact condition to test for, and thus enables inversion of the stated condition. The default is to test if the "Condition is Not Satisfied". If this is selected and the condition evaluates to false, execution will be affected as indicated by the Do property; however if the condition evaluates to true, execution will continue down the current branch. It is possible instead to test if the "Condition is Satisfied", which reverses the outcome.

Do

Determines what happens when the condition and the If property together indicate that execution should not continue down the current branch.

As Specified Under Error Handling

The [Error Handling](#) tab specifies in detail what to do.

Skip Following Steps

Execution down the current branch will stop.

Example

In the following examples, the condition is specified using an expression. This is the default way of specifying the condition.

Test if a text has a specific length:

```
ScratchPad.shortText1.length() == 28
```

Test multiple values at once:

```
PersonInput.isMale && PersonInput.isMarried
```

Test Variables

This action tests the value of one or more variables to determine whether execution should continue down the current branch or if something else should be done. The action is useful for checking that the value in an extracted variable are valid. For example, the action can be used to check that an extracted variable matches the value in an input variable.

To specify the test, add one or more *variable conditions*. Each variable condition compares the value of a selected variable against another value. Depending on the outcome of the comparisons, and on your selection in the If property, execution will either continue down the current branch or be affected as indicated by the Do property.

Properties

The Test Variables action is configured using the following properties:

Conditions

Contains the list of variable conditions. See below for more on how to configure a variable condition.

If

Determines what happens when the variable conditions have been tested.

No Conditions are Satisfied

Execution will continue down the current branch if one or more variable conditions are satisfied; if no conditions are satisfied, execution will be affected as indicated by the Do property.

Any Condition is Not Satisfied

Execution will continue down the current branch only if all variable conditions are satisfied; if one or more conditions are not satisfied, execution will be affected as indicated by the Do property.

Any Condition is Satisfied

Execution will continue down the current branch if no variable conditions are satisfied; if one or more variable conditions are satisfied, execution will be affected as indicated by the Do property.

All Conditions are Satisfied

Execution will continue down the current branch if one or more variable conditions are not satisfied; if all variable conditions are satisfied, execution will be affected as indicated by the Do property.

Do

Determines what happens when the condition and the If property together indicate that execution should not continue down the current branch.

As Specified Under Error Handling

The [Error Handling](#) tab specifies in detail what to do.

Skip Following Steps

Execution down the current branch will stop.

Configuring a Variable Condition

A variable condition compares the value of a selected variable against another value. A variable condition is configured using the following properties:

Variable

The variable (or variable attribute) whose value to test.

Operator

The operator to use when comparing the value of the variable to the other value. See below for a description of the available operators.

Value

The value to compare the variable value against. The value can be specified in several ways using a [Value Selector](#).

Ignore Case

If this option is selected, the comparison will be done in a case-insensitive way.

Always Satisfied if Variable is Empty

If this option is selected, the variable condition will be satisfied whenever the selected variable has no value, regardless of the outcome of the comparison.

Always Satisfied if Value is Empty

If this option is selected, the variable condition will be satisfied whenever the other value is empty, regardless of the outcome of the comparison. This option is useful if comparing the value of an extracted variable against a value in an input variable. If the input variable has no value for a specific attribute, the test of whether the extracted variable attribute value matches the attribute value in the input variable should usually be skipped. This is achieved by selecting this option.

The following operators are available in the Operator property:

Operator	Description
=	Tests whether the two values are equal.
<>	Tests whether the two values are not equal.
<	Tests whether the first value is less than the second value.
<=	Tests whether the first value is less than or equal to the second value.
>=	Tests whether the first value is greater than or equal to the second value.
>	Tests whether the first value is greater than the second value.
contains	Tests whether the first value contains one or more occurrences of the second value. The test is done on the text representation of the values. Note If the first value is empty, the test is never satisfied. Also, if the first value is non-empty and the second value is empty, the test is always satisfied.
does not contain	Tests whether the first value does contain any occurrences of the second value. The test is done on the text representation of the values. Note: If the first value is empty, the test is always satisfied. Also, if the first value is non-empty and the second value is empty, the test is never satisfied.
is contained in	Tests whether the first value occurs one or more times in the second value. The test is done on the text representation of the values. Note: If the second value is empty, the test is never satisfied. Also, if the second value is non-empty and the first value is empty, the test is always satisfied.
starts with	Tests whether the first value starts with the second value. The test is done on the text representation of the values. Note: If the first value is empty, the test is never satisfied. Also, if the first value is non-empty and the second value is empty, the test is always satisfied.
ends with	Tests whether the first value ends with the second value. The test is done on the text representation of the values. Note: If the first value is empty, the test is never satisfied. Also, if the first value is non-empty and the second value is empty, the test is always satisfied.

Note The exact meaning of the operators '<>', '<', '<=', '>=', '>' depends on the type of the selected variable/attribute. For example, if the type is Short Text or Long Text, the comparison is done lexicographically, while it is done numerically if the type is Number or Integer.

Test Window

This action tests whether a specific window exists, in order to determine whether execution should continue down the current branch or if something else should be done.

Note that the window must exist when configuring the Test Window action, in order to be able to select the window.

Properties

The Test Window action can be configured using the following properties:

Window

The window to check the existence of (see the discussion on how to [identify a window](#)).

If

Specifies the exact condition to test for, either that the Window Exists or that the Window Does Not Exist. If this condition is satisfied, execution will be affected as indicated by the Do property; if the condition is not satisfied, execution will continue down the current branch.

Do

Determines what happens when the condition and the If property together indicate that execution should not continue down the current branch.

As Specified Under Error Handling

The [Error Handling](#) tab specifies in detail what to do.

Skip Following Steps

Execution down the current branch will stop.

Transform XML

The Transform XML action transforms an XML document contained in an XML variable using an XSLT stylesheet. The stylesheet is specified as part of the action. The result of the transformation is stored in a variable which can be of type XML, HTML, or Long Text.

The Transform XML step action supports XSLT version 1.0.

The output that the stylesheet generates must be of a type that can be stored in the selected output variable. That is, if the output is to be stored in an XML variable, the stylesheet should specify `<xsl:output method="xml">`. If the output is to be stored in an HTML variable, the stylesheet should specify `<xsl:output method="html">`. If the output is to be stored in a text variable, the output method can be anything since XML, HTML, and text can all be stored as text.

A common use-case is to use an [Extract Target](#) action to store XML from a website in an XML variable, and then use a Transform XML action to transform the data and store it in the same XML variable. Finally, the [Create Page](#) action can be used to create a page displaying the XML document by choosing HTML Converted from XML Variable. This enables easy extraction of data from the transformed document using the standard extraction actions.

Properties

The Transform XML action can be configured using the following properties:

Input Variable

Select the XML variable that contains the input to the transformation. A HTML or Long Text variable can also be chosen, but it must contain valid XML.

XSLT Stylesheet

Specify the XSLT stylesheet to use for the transformation. In most cases the stylesheet will be specified as fixed XML, but you can also create the stylesheet dynamically by choosing XML from Expression or XML from Variable.

Output Variable

Select the variable where the result of the transformation should be stored. Variables of types XML, HTML, and Long Text are allowed. The XSLT stylesheet must create output that can be stored in the selected variable. Note, that the result can be stored in the same variable as the one chosen as XML input.

Transpose Table

The Transpose Table action transposes a table. Transposing a table means turning rows into columns and columns into rows while preserving the ordering between rows and between columns.

Example

As an example, consider the following table with 3 rows and 4 columns (including headers):

NAME	John	Michael	Ross
HEIGHT	1.80	1.56	2.09
WEIGHT	75	93	64

Transposing this table yields the following table with 4 rows and 3 columns (including headers):

NAME	HEIGHT	WEIGHT
John	1.80	75
Michael	1.56	93
Ross	2.09	64

Note Transposing a table twice will not necessarily result in the original table.

Try

The Try step is used when it is necessary to try several alternative approaches to get a particular thing done.

The Try step is similar to a [branch point](#) because it may have several branches going out from it. It differs from a branch point because branches beyond the first one are executed only if a step on the preceding branch activates the error handling option [Try Next Alternative](#) (or, in legacy robots, "Send Backwards"). A detailed description can be found in the Design Studio help, [Trying Several Alternatives](#).

Unhide Tag

This action unhides the found tags.

The un hiding is done by configuring the style attribute of the tags such that the tags becomes visible on the page.

View as CSV

This action opens downloaded CSV content in a CSV view.

The step action only works on downloaded CSV content.

Properties

The View As CSV action can be configured with the following properties:

Use headers

This property is checked if the first row of the CSV document defines column names.

Separator Character

The separator used to parse the CSV document.

Quote Character

The quote used to parse the CSV document.

Additional Escape Character

The CSV-parser interprets the double quote character (") as an escape character if it is followed by another double quote character. If an additional escape character is used, the user may provide it here.

Encoding

The encoding used for this CSV document.

Skip Top Lines

Sets the number of lines to skip from the top of the CSV-file. This is particularly useful if a system has automatically appended a number of lines at the beginning of the CSV-file that are not part of the actual CSV-data.

Skip Bottom Lines

Sets the number of lines to skip at the bottom of the CSV-file. This is particularly useful if a system has automatically appended a number of lines at the end of the CSV-file that are not part of the actual CSV-data.

View as Excel

This action opens downloaded Excel content in an Excel view.

The step action only works on downloaded Excel content.

Properties

There are not currently any properties.

View as JSON

This action opens downloaded JSON content in a JSON view.

The step action only works on downloaded JSON content.

Properties

The View As JSON action can be configured with the following properties:

Encoding

The encoding used for the JSON document.

View as XML

This action opens downloaded XML content in an XML view.

The step action only works on downloaded XML content.

Properties

There are not currently any properties.

Wait

This action waits for a specified period of time. Wait is only performed during runtime execution, not during execution in Design mode in Design Studio.

Properties

The Wait action can be configured using the following properties:

Seconds

The number of seconds to wait. The value of seconds must be non-negative and can be specified in several ways using a [Value Selector](#).

Write File

This action writes a new file or appends to an existing file.

Note that the file is only written during execution in Design mode in Design Studio, if the option Execute in Design Mode has been selected.

To test whether a given file exists, use the [Test File Existence](#) action.

If a CSV (Comma-Separated Value) file should be written, it can be done in two ways: Either write the file one line at a time with Write File, using an Add To CSV data converter to create each line. Alternatively, build up the desired file contents one line at a time in a global variable (again with the aid of the Add To CSV data converter) and use Write File in the end (that is, in an additional branch) to write the file in one piece.

In order to modify the global variable that holds the file contents, use an Assign Variable action that takes its input from a Get Variable data converter pointing to the variable itself. This is then followed by the Add To CSV data converter.

Properties

The Write File action can be configured using the following properties:

File Name

The name of the file. The name can be specified in several ways using a Value Selector. The name must be an absolute file name, including the drive name, if any, and the directory path to the file.

File Content

The contents to write to the file. The contents can be specified in several ways using a Value Selector. The contents can be either binary data or text. In the latter case, the character encoding selected in the File Encoding property will be used for encoding the text as bytes. See above for how to use converters to provide file contents for CSV, XML and JSON files.

File Encoding

If the contents to write to the file is text, this property specifies the character encoding to use for encoding the text as bytes.

Append to File

Specifies whether a new file should always be created (overwriting any existing file with the same name), or whether the contents should be appended to the file if it already exists.

Create Directories

Specifies whether to create the necessary directories on the file path before creating a new file. If not selected, then the action will fail if any directory on the path does not exist.

Execute in Design Mode

If this is enabled, the action will be executed even in Design Mode inside Design Studio. If this is disabled, the action will do nothing when you navigate the robot in Design Mode.

Write Log

This action provides a opportunity to write information to the log system.

Exactly what the log system is, depends on how the robot is being run. If the robot is running in design mode in Design Studio, the log information will be shown in the Log Window, which can be opened from the View menu. If the robot is running in debug mode, the log will be shown in the Log tab. If the Robot is run using RoboServer, the log information might be sent to a message database or somewhere else, depending on the configuration of Kapow.

Properties

The Write Log action can be configured using the following properties:

Message

This field contains a message that is written to the log. The value of this can be specified in several ways using a Value Selector.

Data Converters

This section provides an overview of the available data converters.

The descriptions of the data converters below refer to the concepts of patterns and expressions, both of which are central text manipulation concepts in Kapow. For a description of these two concepts, see [Patterns](#) and [Expressions](#).

You can also view the [Data Conversion](#) tutorial.

Standard

This category contains the most commonly used data converters. The most common way to process a text is to use Extract. It allows you to extract a piece of text using a pattern. To evaluate an expression, use Evaluate Expression. To add a text, use Add Text. To convert a text using a list of conversion rules, use Convert Using List. To get the value of a variable, use Get Variable.

Action	Description
Extract	This data converter extracts a piece of text from the input text using a pattern. The part that you wish to extract should be marked with a pair of parenthesis.
Evaluate Expression	This data converter outputs the result of an expression. The input text to the data converter can be used in the expression by using the INPUT notation.
Add Text	This data converter adds a text before or after the input text.
Convert Using List	This data converter converts the input text to an output text using a list of conversions.
Get Variable	This data converter fetches the value of a variable. The input text is ignored.

Extraction

This category contains data converters for extraction. The most commonly used one is Extract. It allows you to extract a piece of text using a pattern. If you need more advanced extraction features, use Advanced Extract. To apply the functionality of Advanced Extract multiple times on the same text, use Extract List.

Action	Description
Extract	This data converter extracts a piece of text from the input text using a pattern. The part that you wish to extract should be marked with a pair of parenthesis.
Advanced Extract	This data converter matches the input text against a pattern and outputs the result of an expression.
Extract List	This data converter finds all matches of a pattern, and for each match, evaluates an expression. The output text is a list of the results of the expression.

Text Formatting

This category contains data converters for various kinds of text formatting. To add a text, use Add Text. To search and replace text, use Replace Text. To search and replace text using a pattern, use Replace Pattern. To remove spaces from the input text, use Remove Spaces. To remove all special characters, use Remove Special Characters. To remove all non-printable characters, use Remove Non-Printable Characters. To change case, use Convert to Lower Case, Convert to Upper Case, or Capitalize.

Action	Description
Add Text	This data converter adds a text before or after the input text.
Replace Text	This data converter finds and replaces matching text in the input text.
Replace Pattern	This data converter replaces every match of a pattern with the result of an expression.
Remove Spaces	This data converter removes spaces from the input text.
Remove Special Characters	This data converter replaces all special characters in the input text with spaces.
Remove Non-Printable Characters	This data converter removes all non-printable characters.
Convert to Lower Case	This data converter converts all characters in the input text to lower case.
Convert to Upper Case	This data converter converts all characters in the input text to upper case.
Capitalize	This data converter capitalizes the input text, i.e. makes the first character in every word upper case, and the remaining characters lower case.
Unquote Text	This data converter unquotes text that has been enclosed in double or single quotes.

Number Handling

This category contains data converters for handling numbers. To extract a number from a text, use Extract Number. To format a number that is already in the standard number format, use Format Number.

Action	Description
Extract Number	This data converter extracts a number from the input text and outputs the number in the standard number format.
Format Number	This data converter reformats a number that is in the standard number format.

Date Handling

This category contains data converters for handling dates. To extract a date from a text, use Extract Date. To extract a year from a text, use Extract Year. To format a date that is already in the standard date format, use Format Date. To get the time between two dates, use Get Time Between Dates. To modify a date, use Modify Date.

Action	Description
Extract Date	This data converter extracts a date from the input text and outputs the date in the standard date format.
Extract Year	This data converter extracts a year from a date in the input text.
Format Date	This data converter reformats a date that is in the standard date format.
Get Time Between Dates	This data converter allows you to find the difference between two dates. It compares the date in the input text to a given date and calculates the difference, measured in the selected unit.
Modify Date	This data converter modifies the input date by adding or subtracting an amount from a selected part of the date. If this causes that part of the date to overflow or underflow, the other parts of the date will be updated accordingly. A time zone, in which the modifications are performed, can be specified.
To Excel Date	Converts a date from a standard date format to an Excel format.
From Excel Date	Converts a date from an Excel format to the standard date format.

HTML Handling

This category contains data converters for handling HTML. To remove all HTML tags from a text, use Remove Tags. To convert HTML to plain, structured text, use Convert HTML to Text. To reformat (pretty-print) HTML, use Format HTML. To count the number of times that a specific tag appears in the input text, use Count Tags.

Action	Description
Remove Tags	This data converter removes HTML tags from the input text.
Convert HTML to Text	This data converter converts the input HTML text to plain text, and structures the text similarly to how it would appear in a browser.
Format HTML	This data converter reformats (pretty-prints) the input HTML text.
Count Tags	This data converter counts tags with the name matching exactly the name given in the Tag Name field. If you want the converter to count only tags, that has a corresponding end tag within the input string, check the 'Require End Tag' checkbox.

Output Format Handling

This category contains data converters for handling output formats. Each data converter can format an object into a specific output format and add it to the input text (supposed to be a previously created partial result). Alternatively, any piece of text can be added to the input text according to the rules of the chosen output format.

Action	Description
Add to XML	This data converter extends a piece of XML with another piece of XML, optionally creating it first from a variable.

Encoding and Decoding

This category contains data converters for encoding and decoding. To decode or encode ampersands, use Ampersand Decode or Ampersand Encode. To encode or decode URLs, use URL Encode or URL Decode. To Base64 encode or decode binary data, use Base64 Encode or Base64 Decode.

Action	Description
Ampersand Encode	This data converter encodes characters with ampersand encodings, which is replacing certain characters with "&<something>".
Ampersand Decode	This data converter decodes all HTML ampersand encodings into their real characters.
URL Encode	This data converter encodes characters with URL encodings.
URL Decode	This data converter decodes all URL encodings into their real characters.
Base64 Encode	This data converter encodes data using Base64 encoding.
Base64 Decode	This data converter decodes Base64 encoded data.
Convert Binary to Text	Converts a binary variable to text. The input text is ignored.
Convert Text to Binary	Converts a text variable to its binary Hex representation. The input text is ignored.

Other

This category contains various other data converters.

Action	Description
Evaluate Expression	This data converter outputs the result of an expression. The input text to the data converter can be used in the expression by using the INPUT notation.
Convert Using List	This data converter converts the input text to an output text using a list of conversions.
Convert Using JavaScript	This converter allows you to define the conversion using JavaScript. The input is available in the INPUT variable, and the result of the conversion must be assigned to the OUTPUT variable.
If Then	The If Then data converter allows you to specify a list of if-then rules that determine the output of the converter.
Get Variable	This data converter fetches the value of a variable. The input text is ignored.
Get Property	This data converter fetches the value of a property from a property list contained in a variable.
Make URL Absolute	This data converter makes a URL absolute.

Action	Description
Make URL Relative	Make URL Relative
Compute MD5 Checksum	This data converter computes an MD5 checksum of the input text.

Deprecated

This category contains data converters that have been replaced by newer versions or have otherwise become obsolete. They are available only for backwards compatibility with robots written using earlier versions of Design Studio. Do not use these data converters in new robots.

Add Text

This data converter provides the ability to add text before or after the input text.

Properties

The Add Text data converter is configured using the following properties:

Text to Add

This field contains the text to add to the input text.

Add Where

Select whether to add the text before or after the input text.

Description

Type in a description to be shown in the list of data converters. If there is no type in a description, one will be generated.

Add To CSV

This data converter converts a variable to CSV format and adds it to the input text.

See the [Write File](#) action for help on how to use this data converter to create and write the contents of a complete CSV file.

Properties

The Add To CSV data converter is configured using the following properties:

Variable to Format

Specify a variable, which will be formatted as CSV before being added at the end of the input text. The CSV will include all of the attributes of the variable, except those not marked as "storable".

Create Header

If this is checked, a header row is created that matches the selected variable. The storage names (or by default the names) of the variable's attributes are used as column titles in this header. If this property is left unchecked, a data row is created containing the values of the variable's attributes.

Date Format Locale

When creating a data row, the desired locale for dates needs to be specified just as for the [Format Date](#) data converter.

Date Format Pattern

When creating a data row, the desired date format pattern needs to be specified just as for the [Format Date](#) data converter.

Field Separator

The desired separator between individual fields in a row. This can be either a comma or a TAB character. When comma is selected, field values can optionally be put in quotes (" characters). In this case, quote characters in field values are doubled (so that " becomes ""). For quoted, comma-delimited values you can also specify whether the comma should be followed by a space or not.

Description

Type in a description to be shown in the list of data converters. If there is no type in a description, one will be generated.

Advanced Extract

This data converter allows manipulation of the input text in a flexible way using a pattern and an expression. The pattern can be used to extract text pieces from the input text, and these text pieces can then be used in the expression to construct the output text.

Properties

The Advanced Extract data converter is configured using the following properties:

Pattern

Contains a pattern that is matched against the input text. Note that the pattern must match the entire input text. Otherwise, the converter will fail, producing an error.

Ignore Case

If this option is selected, the pattern matching is case-insensitive, i.e. the pattern is matched against the input text without regard for character case.

Output Expression

Contains an expression whose result becomes the output of the data converter. The expression can refer to the submatches of the pattern using the \$n notation. For example, \$1 can be entered in the expression to get the first submatch in the pattern (i.e. the text that matches the contents of the first pair of parentheses in the pattern).

Description

Type in a description to be shown in the list of data converters. If there is no type in a description, one will be generated.

Ampersand Decode

This data converter decodes all HTML ampersand encodings into their real characters.

Properties

The Ampersand Decode data converter can be configured using the following properties:

Convert NBSP To Regular Space

Specifies that ` ` should be converted to a regular space instead of a non-breakable space.

Description

Type in a description to be shown in the list of data converters. If there is no type in a description, one will be generated.

Example

If the input text is

```
&lt; &gt; &amp; &quot;
```

this data converter will output:

```
< > & "
```

Ampersand Encode

This data converter encodes characters with HTML ampersand encodings.

For more information, consult:

<http://www.w3.org/TR/html401/charset.html#h-5.3.2>

Properties

The Ampersand Encode data converter can be configured using the following properties:

Description

Type in a description to be shown in the list of data converters. If there is no type in a description, one will be generated.

Example

If the input text is

```
< > & " á ç a
```

this data converter will output:

```
&lt; &gt; &amp; &quot; &#223; &#227; a
```

Base64 Decode

This data converter decodes Base64 encoded text data into binary.

Properties

The Base64 Decode data converter can be configured using the following properties:

Description

Type in a description to be shown in the list of data converters. If there is no type in a description, one will be generated.

Example

If the input text is

```
yv66vg==
```

this data converter will output:

```
CA FE BA BE
```

Important The base64 Decode converter does not support dash ("-") and underscore ("_") characters, therefore it is necessary to replace those characters before doing the Base64 decoding. Use "+" instead of "-" and "/" instead of "_".

Base64 Encode

This data converter encodes binary data into a string using Base64 encoding.

Properties

The Base64 Encode data converter can be configured using the following properties:

Description

Type in a description to be shown in the list of data converters. If there is no type in a description, one will be generated.

Example

If the input text is

```
CA FE BA BE
```

this data converter will output:

```
yv666vg==
```

Boolean Converter

The Boolean converter converts any pattern and returns a Boolean value: true or false if there is any pattern found. If no pattern found, no value is returned and instead, a warning message is displayed on top of the Test Input window.

Using the Boolean Converter

You can access the converter as follows:

- Extracting boolean data using the Extract action
 - On the **Action** tab, select **Extract** > **Extract** then click the plus sign under **Converters** and select **Boolean Handling** > **Extract Boolean**.
- Using the right-click menu in the Page view

Right-click the text you want to extract from and select the appropriate option on the **Extract** menu.

Properties

The Boolean converter is configured using the following properties:

Formats

Displays defined patterns and expected results: true or false.

Pattern

The Pattern list contains default suggested patterns like yes, no and etc. You can also click the drop-down box to the right of the **Pattern** list and choose from Value, Variable, Expression, or Converters.

Ignore Case

If this option is selected, the action ignores the case of the pattern's content.

Value

Select **True** or **False** from the list.

Test Input

Enter an input value for testing.

Test Output

A corresponding output is displayed according to the defined formats.

Converting rules

- By default, if the input text is a boolean value itself, the output is the same as the input. Note that it is case sensitive. This rule only applies to lower case true and false.
- The order of the formats matters, that is the action starts searching for matching formats from the top. When any matching pattern is found, the result is returned regardless of any other patterns located below the found one.

Capitalize

This data converter capitalizes the input text. This means that the first character in every word will be made upper case, while the remaining characters will be made lower case.

Properties

The Capitalize data converter can be configured using the following properties:

Words that Should not Be Capitalized

Contains the words that should not be capitalized. The words are separated by commas. For example, if the words "in" and "the" should not be capitalized, set the property to "in, the".

Minimum Length of Words to Capitalize

The minimum length of the words that should be capitalized. For example, if this property is set to 3, all words with fewer than 3 characters will not be capitalized.

Description

Type in a description to be shown in the list of data converters. If there is no type in a description, one will be generated.

Example

If the input text is

```
'hello WORLD'
```

then the output text becomes:

```
'Hello World'
```

Compute MD5 Checksum

The Compute MD5 Checksum data converter computes an MD5 checksum of the input text.

This data converter is useful for creating a digital fingerprint of a text or binary data, in order to easily detect changes in the data at some later point. Since MD5 checksum can only be applied to binary data, any string input must be encoded before the MD5 can be applied. If the checksum generated from text is to be compared against a checksum generated by an external MD5 service, ensure that the external service used the same encoding as the robot.

Any text can be given as input, including the hexadecimal text representation that will result if it is read from an attribute containing binary data. The output of the data converter will be a 128-bit MD5 checksum of the text, represented as a 32-digit hexadecimal number. For all practical purposes, this number can be considered a unique identification of the input text. That is, in practice, two texts will never occur that result in the same MD5 checksum.

Properties

The Compute MD5 Checksum data converter can be configured using the following properties:

Encoding

The encoding used to encode the text before applying the md5.

Description

Type in a description to be shown in the list of data converters. If there is no type in a description, one will be generated.

Example

If the input text is

```
The quick brown fox jumps over the lazy dog
```

then the output will be:

```
9E107D9D372BB6826BD81D3542A419D6
```

Even small changes in the input text will result in a completely different output. For example, if you change the 'd' in "dog" to an 'h', so that the input becomes:

```
The quick brown fox jumps over the lazy hog
```

then the output will be:

```
5681F8C64F7CA70B12E0B80435265203
```

Convert Binary to Text

Converts the contents of a binary variable to text, using the selected encoding. The input text is ignored. This action is used when HTML, XML, or text files are passed as input to a robot through a binary variable.

Properties

The Convert Binary to Text data converter is configured using the following properties:

Variable

The variable whose value to get. This must be a binary attribute.

Encoding

The encoding used to decode the bytes in the binary variable. Binary content which can be converted into text is most often encoded in UTF-8, Latin-1 (ISO-8859-1), or Latin-1 (Windows-1252). If the text generated by this conversion contains the character '#', the selected encoding is wrong or the character is non-displayable.

Description

Type in a description to be shown in the list of data converters. If there is no type in a description, one will be generated.

Convert from Excel Date

This data converter converts the date from an Excel number to a standard format.

Properties

The Convert from Excel Date data converter can be configured using the following properties:

Description

Type in a description to be shown in the list of data converters. If there is no type in a description, one will be generated.

Example

If the input text is

```
1
```

then the output text becomes:

```
1900-01-01 00:00:00.0
```

Convert HTML to Text

This data converter converts the HTML input text to plain text, and structures the text similarly to how it would appear in a browser.

Properties

The Convert HTML to Text data converter can be configured using the following properties:

Include Aligned Tables and Images

Specifies that the tables and images that are aligned to the left or right of the text are included in the output text. Disabling this can sometimes result in removing the desired content.

Include URLs

Specifies that the actual URLs in link tags will be included in the output text.

Include Image Text Alternatives

Specifies that the text representation of images will be included in the output text.

Include Form Fields

Specifies that the text representation of form fields will be included in the output text.

Insert This Before a Heading

Specifies that this data converter should guess at the location of headings and insert the specified text before them.

Insert This After a Heading

Specifies that this data converter should guess at the location of headings and insert the specified text after them.

Keep Ampersand Encodings

Specifies that ampersand encodings will not be decoded. Text in script and style sheet will be respected.

Description

Type in a description to be shown in the list of data converters. If there is no type in a description, one will be generated.

Convert Text to Binary

Converts the contents of a text variable into its binary Hex representation, using the selected encoding. This step can be used to encode text as binary for file upload.

Properties

The Convert Text to Binary data converter is configured using the following properties:

Encoding

The encoding used to encode the text.

Description

Type in a description to be shown in the list of data converters. If there is no type in a description, one will be generated.

Convert to Excel Date

This data converter converts the date to an Excel number that represents the same date in a spreadsheet.

Properties

The Convert to Excel Date data converter can be configured using the following properties:

Description

Type in a description to be shown in the list of data converters. If there is no type in a description, one will be generated.

Example

If the input text is

```
1900-01-01 00:00:00.0
```

then the output text becomes:

```
1.0
```

Convert to Lower Case

This data converter converts all characters in the input text to lower case.

Properties

The To Lower Case data converter can be configured using the following properties:

Description

Type in a description to be shown in the list of data converters. If there is no type in a description, one will be generated.

Example

If the input text is

```
"HELLO World"
```

then the output text becomes:

```
"hello world"
```

Convert to Upper Case

This data converter converts all characters in the input text to upper case.

Properties

The To Upper Case data converter can be configured using the following properties:

Description

Type in a description to be shown in the list of data converters. If there is no type in a description, one will be generated.

Example

If the input text is

```
"hello World"
```

then the output text becomes:

```
"HELLO WORLD"
```

Convert Using JavaScript

This data converter provides the opportunity to specify the conversion using JavaScript. This data converter may for instance be useful when working with advanced text manipulation such as URL rewriting, or performing complex calculations.

The input to the converter is available in an implicitly defined INPUT variable. The result of performing the conversion must be assigned to an OUTPUT variable. Helper functions can be defined and called if needed. Note that access to the browser state from the JavaScript is not possible in this converter.

Properties

The Convert Using JavaScript data converter is configured using the following properties:

Script

The JavaScript to execute. This may be specified literally or created in several different ways using a Value Selector

Description

Type in a description to be shown in the list of data converters. If there is no type in a description, one will be generated.

Example: JavaScript Conversion

Example 1

To calculate the average of a comma-separated list of numbers, we configure the Convert Using JavaScript data converter with the following script that performs the calculation:

```
var sum = 0;
var numbers = INPUT.split(",");
for (var i = 0; i < numbers.length; i++) {
    sum += parseInt(numbers[i]);
}

OUTPUT = sum / numbers.length;
```

The JavaScript reads the list of numbers, e.g. "23,22,25,31,24" from the INPUT variable, splits it at each comma using the built-in JavaScript `split()` function, iterates through the numbers to calculate the sum (note that the `parseInt()` function is used to convert from string to integer; otherwise we would be concatenating the strings rather than calculating the sum), and finally calculates the average and assigns the result to the OUTPUT variable.

In the case where the input to the data converter is the string "23,22,25,31,24", the output of the converter will thus be 25.

Example 2

To calculate the maximum of a comma-separated list of amounts, e.g. "\$10.50,\$13,\$21.75,\$7", we configure the Convert Using JavaScript data converter with the following script that performs the calculation:

```
function getNumber(amountWithDollarSign) {
    return parseFloat(amountWithDollarSign.substring(1));
}

var amountsWithDollarSigns = INPUT.split(",");
var max = getNumber(amountsWithDollarSigns[0]);
for (var i = 1; i < amountsWithDollarSigns.length; i++) {
    max = Math.max(max, getNumber(amountsWithDollarSigns[i]));
}

OUTPUT = max;
```

In the above JavaScript, we have defined a helper function named `getNumber()` that removes the preceding dollar sign from the amount and converts the rest into a floating-point number. This function is called repeatedly in script. The built-in JavaScript function `Math.max()` used to find the maximum of two numbers; in each iteration, the highest number found so far is compared with the next number.

Finally, the highest number found is stored in the OUTPUT variable and becomes the output of the data converter.

String Manipulation

The following methods are useful when converting String objects. Notice that strings are written inside "" whereas regexp are written within //. A global g attribute at the end of a regexp indicates that the method should apply to all matches.

Method	Description
<code>string.charAt(n)</code>	Returns the character with index n.
<code>string.charCodeAt(n)</code>	Returns the Unicode value of the character with index n.
<code>string.concat(value1, value2, ...)</code>	One or more values are concatenated to string.
<code>String.fromCharCode(c1, c2, ...)</code>	Creates a new string from integers specifying the Unicode encodings of the characters.
<code>string.indexOf(substring)</code> <code>string.indexOf(substring, start)</code>	Returns the index of substring within string.start specifies the index at which the search should start (0 being the first character in the string and <code>string.length-1</code> being the last. Default is 0).
<code>string.lastIndexOf(substring)</code> <code>string.lastIndexOf(substring, start)</code>	Returns the position of the last occurrence of substring within string.start specifies the index at which the search should start (0 being the first character in the string and <code>string.length-1</code> (which is default) being the last).
<code>string.length</code>	Character length of string.

Method	Description
<code>string.match(regex)</code>	Searches string for matches with a regular expression <code>regex</code> . Returns only the first match unless <code>regex</code> has the global attribute specified (<code>g</code>), by which an array containing all results from the match is returned.
<code>string.replace(regex, replacement)</code> <code>string.replace(substring, replacement)</code>	Searches string for matches with a substring or a regular expression and replaces the first occurrence with <code>replacement</code> . If <code>regex</code> has the global attribute specified (<code>g</code>), all occurrences are replaced with <code>replacement</code> .
<code>string.search(regex)</code>	Returns the index of the first character of the first match with a regular expression.
<code>string.slice(start, end)</code>	Returns a string containing all characters from <code>start</code> through <code>end-1</code> .
<code>string.split(delimiter, limit)</code>	<code>delimiter</code> is a string or regular expression which specifies the places at which to split string. Returns an array of strings. The array is no longer than <code>limit</code>
<code>string.substr(start, length)</code>	Returns a copy of the substring starting from index <code>start</code> and being of the length <code>length</code> .
<code>string.substring(from, to)</code>	Returns the substring starting at position <code>from</code> and ending at <code>to-1</code> .
<code>string.toLowerCase()</code>	Returns a copy of string converted to lower case.
<code>string.toUpperCase()</code>	Returns a copy of string with all letters converted to upper case.

The Math Object

The following properties and methods are useful when doing mathematical computations. All angles are measured in radians.

Property / Method	Description
<code>Math.E</code>	Returns Euler's number.
<code>Math.LN10</code>	Returns the natural logarithm of 10.
<code>Math.LN2</code>	Returns the natural logarithm of 2.
<code>Math.LOG10E</code>	Returns the base-10 logarithm of E.
<code>Math.LOG2E</code>	Returns the base-2 logarithm of E.
<code>Math.PI</code>	Returns pi.
<code>Math.SQRT1_2</code>	Returns the square root of 1/2.
<code>Math.SQRT2</code>	Returns the square root of 2.
<code>Math.abs(x)</code>	Returns the absolute value.
<code>Math.acos(x)</code>	Computes arc cosine.
<code>Math.asin(x)</code>	Returns arc sine.
<code>Math.atan(x)</code>	Computes arc tangent.
<code>Math.atan2(y, x)</code>	Computes the angle to a point. The input represent the usual (x,y)-coordinates, but the order has been reversed.
<code>Math.ceil(x)</code>	Rounds up a number.
<code>Math.cos(x)</code>	The cosine function.
<code>Math.exp(x)</code>	Takes e to the power of x.
<code>Math.floor(x)</code>	Rounds down a number.
<code>Math.log(x)</code>	Computes the natural logarithm.
<code>Math.max(x1, x2, ...)</code>	Returns the largest of the numbers.

Property / Method	Description
Math.min(x1, x2, ...)	Returns the smallest of the numbers.
Math.pow(x,y)	Computes x to the power of y
Math.random()	Returns a random number between 0 and 1
Math.round(x)	Rounds to nearest integer.
Math.sin(x)	The sine function.
Math.sqrt(x)	Computes the square root.
Math.tan(x)	The tangent function.

Numbers

It is possible to convert from a Number to a String using String(number) and vice versa using Number(string). Here are some of the useful methods of the Number object.

Method	Description
number.toExponential(digits)	Specifies the number of digits that will occur after the decimal point. Returns a string representation of number in exponential notation.
number.toFixed(digits)	Specifies the number of digits that will occur after the decimal point. Returns a string representation of number that does not use exponential notation.
number.toPrecision(precision)	Specifies the number of significant digits. Returns a string representation of number with the specified number of significant digits.
number.toString(base)	Returns a string representation of the number using the specified base.

Convert Using List

This data converter converts the input text to an output text using a list of conversions. The data converter is useful when converting from the texts used on a particular website to the texts used here, or vice versa. For example, the data converter can be used to convert between country names and country codes.

Specifying the list of conversions

The list of conversions is specified in the Conversions field. For example, a list of conversions from country name to country code could look like this:

```
"Australia" = "AUS"
"Austria" = "AUT"
"Belgium" = "BEL"
"Brazil" = "BRA"
"Canada" = "CAN"
"China" = "CHN"
"Denmark" = "DNK"
"Egypt" = "EGY"
"Finland" = "FIN"
"France" = "FRA"
"Germany" = "DEU"
"Hungary" = "HUN"
"Iceland" = "ISL"
"India" = "IND"
"Ireland" = "IRL"
...
```

With this list of conversions, the input text "Australia" will be converted to "AUS", the input text "Austria" will be converted to "AUT", etc.

The backslash character (\) can be used to enter special characters in the texts:

- \n for line break.
- \r for carriage return.
- \f for form document.
- \t for horizontal tab.
- \b for backspace.
- \" for double quote.
- \' for single quote.
- \\ for backslash itself.
- \uxxxx for the unicode character with encoding xxxx, where xxxx is four hexadecimal digits.

Quotes around a text can be omitted. In that case, all spaces at the start and end of the text will be removed, the text cannot be empty, and the backslash notation can not be used to enter special characters.

The list of conversions can contain empty lines and comment lines. A comment line starts with two forward slash characters (//).

Handling the case where no conversion matches

The If No Matching Conversion option determines what happens in the case where the input text does not match any of the conversions:

- *Generate Error* will cause an error to be generated by the data converter. The error will be handled according to the configuration of the step that uses the data converter.
- *Do Not Convert Text* will prevent the input text from being converted, i.e. the input text will be used as output text without any conversion.
- *Convert to Default Text* will cause the input text to be converted to the text specified in the Default Text field.

Note: The text in the Default Text field is specified *without* quotes. If there needs to be a quote character inside the text, it can be entered directly (do not use the \" notation).

Other Properties

The Convert Using List data converter can additionally be configured using the following properties:

Description

Type in a description to be shown in the list of data converters. If there is no type in a description, one will be generated.

Count Tags

The Count Tags data converter counts the number of times that a specific tag appears in the input text. It matches the tag name exactly.

Properties

The Count Tags data converter can be configured using the following properties:

Tag Name

In this field, you enter the name of the tag that you want to count, e.g. "tr".

Require End Tag

If this is checked, only the tags that have both start and end tags are counted.

Description

Type in a description to be shown in the list of data converters. If there is no type in a description, one will be generated.

Evaluate Expression

This data converter provides an opportunity to evaluate an expression.

The input text to the data converter can be used in the expression by using the INPUT notation, see the examples below.

Properties

The Evaluate Expression data converter is configured using the following properties:

Expression

Contains an expression whose result becomes the output of the data converter. The expression can refer to the input text by using the INPUT notation, see the examples later in this topic.

Description

Type in a description to be shown in the list of data converters. If there is no type in a description, one will be generated.

Examples

Get the current date and time can happen with this expression:

```
now()
```

If the input text is "The time is " and the current time should be added, this expression can be used:

```
INPUT + time(now())
```

Numeric calculations can also be performed. For example, if the integer attribute Item.price contains 95 and the number attribute Customer.discount contain 25.0 then the discount can be computed:

```
(Item.price * Customer.discount)/100
```

Likewise, if the input text is "10", it can be multiplied by 20 by using this expression:

```
toInteger(INPUT) * 20
```

Extract

This data converter provides a possibility to extract a text piece from the input text in a simple way using a pattern. The piece to extract should be marked with a pair of parentheses (i.e. the extracted text piece is the first submatch in the pattern).

For more advanced extraction options, e.g. to extract more than one piece of text or to have manipulation options, use the [Advanced Extract](#) data converter instead.

Properties

The Extract data converter is configured using the following properties:

Pattern

Contains a pattern that is matched against the input text. The part of the input text to extract should be marked with a pair of parentheses. Note that the pattern must match the entire input text. Otherwise, the converter will fail, producing an error.

Ignore Case

If this option is selected, the pattern matching is case-insensitive, i.e. the pattern is matched against the input text without regard for character case.

Description

Type in a description to be shown in the list of data converters. If there is no type in a description, one will be generated.

Example

If the first word in the input text should be extracted, use the pattern

```
(\S*)\s?.*
```

This extracts the first sequence of non-whitespace characters.

Extract Date

This data converter finds and extracts a date. The extracted date is output in the standard date format.

Note: If a date that is already in the standard date format should be reformatted, use the [Format Date](#) data converter instead.

See *Date Extraction* tutorials in the [Advanced Tutorials](#) section for additional information about date extraction techniques.

Properties

The Extract Date data converter is configured using the following properties:

Basic Formats

The date formats, in the order that they should be tried. The first date format that matches the input will be applied. If none match, the data converter will generate an error. Click the '+' sign at the top of the list to add a new date format. The data converter supports two kinds of date formats: Format patterns and relative dates. Format patterns allow specification of a date using patterns like MM/dd yyyy hh:mm. Missing month, date or year fields will be taken relative to today's date, depending on whether the date is expected to belong to the past or the future - see the description of the Direction in time property. A format pattern has the following properties:

Pattern

A pattern that specifies the format of the date to be extracted. See the Syntax of the Relative Date Pattern section later in this topic.

Locale

Specifies the locale that is used in the input. This is for instance used if the input contains the names of months or weekdays, as in 'Monday, 25 May 2009'.

Default Date

This option can be used to specify a date other than the current date to resolve incomplete dates. By default the option is set to Current Date.

Advanced

This tab contains options for specifying a future or a past date. The date that the input should be understood relative to. By default, this is the expression now(), which yields the current date and time.

Direction in time

Specify whether the date to be extracted is a past or future date. This allows the data converter to fill out the missing information if the month and/or year is missing from the format pattern, or when extracting from a relative date. For instance, if extracting from '3 hours ago', the direction in time should be set to 'Past date' in order for the 3 hours to be subtracted from the date specified in 'Relative to', while the direction in time should be set to 'Future date' if you are extracting from input like 'in 5 days'.

Default Time Zone

The default time zone of the date in the input text. If no time zone is selected, no default time zone is used. If a time zone is selected, this time zone is used when no time zone is found in the input text.

Result Time Zone

The time zone to which the date should be converted. If no time zone is selected, no conversion will be done. If a time zone is selected, the date found in the input text will be converted from its time zone (or the default time zone; see above) to this time zone. If the date in the input text has no time zone and no default time zone is selected, no conversion is done.

Constants

Specify language-dependent constants for extracting relative dates where some numbers may be written out rather than specified with numbers. For instance, to be able to extract a date from the input 'Updated an hour ago', a relative date format with the pattern 'HOURS hour[s] ago' must be specified and it is important to make sure that the constant 'an = 1' is defined.

Description

Type in a description to be shown in the list of data converters. If there is no type in a description, one will be generated.

Syntax of the Format Pattern

The following patterns can be combined to create the pattern in the Pattern property:

Pattern	Description
yy	Exactly two digit year
yyy	Any year
yyyy	Exactly four digit year
G	Era marker (AD or BC)
MM	One or two digit month, abbreviations or full names of months
dd	One or two digit date
EEE	Short weekday name (for example, Mon instead of Monday).
EEEE	Full weekday name (that is Monday, Tuesday, etc).
hh or HH	One or two digit hour
mm	One or two digit minute
ss	One or two digit second
a	AM or PM marker
Z	Time Zone identifier (e.g. "PST", "Central European Time" or "GMT+02:00")
*	Skip any number of characters
Space	Skip one or more white spaces
Any other character	Skip that exact character

If the weekday patterns ('EEE' and 'EEEE') are used and the date pattern ('dd') is *not* used, then the month and year patterns ('MM' and 'yy'/'yyy'/'yyyy') cannot be used. In this case, the date found is the next day with a name matching the pattern. For example, if the pattern is 'EEEE' and the input is the following text:

```
Wednesday
```

the date found is the next Wednesday.

If the weekday patterns are used together with the date pattern (and possibly the month and year patterns), the weekday is discarded. For example, if the pattern is 'EEE, dd/MM/yyyy' and the input is the following text:

```
Mon, 16/03/2003
```

the date found is '2003-03-16 00:00:00.0' (ignoring whether this is a Monday or not).

Note: The 'EEE' pattern matches the short names of the weekdays (e.g. Mon, Tue etc.). If the pattern should match the *entire* weekday name, use the 'EEEE' pattern. For example, if the input is the following text:

```
Thus, let us meet on Wednesday
```

the pattern 'EEEE' should be used, since the pattern 'EEE' would match 'Thu' causing the Date Extractor to find next Thursday.

Example: Format Patterns and Matching Dates

Format Pattern	Matching Dates
dd/MM-yyy	7/6-78 24/12-2001 1/jan-2001
dd. MM yyy	4. jan 1993 4. january 93
yyyy G	2000 AD

Syntax of Relative Date Pattern

The following date fields can be used in the pattern in the Pattern property of a relative date:

Date Field	Description
SECONDS	Seconds
MINUTES	Minutes
HOURS	Hours
DAYS	Days
MONTHS	Months
YEARS	Years

Note that time markers like "ago" are not automatically recognized by the step, therefore to extract a relative date in the past, select **Past date** in the **Direction in time** list on the **Advanced** tab. The robot then subtracts the extracted number from the current time.

To extract the date in the future, select **Future date** in the **Direction in time** list on the **Advanced** tab. The robot then adds the extracted number to the current time.

For example, if you want to get the exact time of the "123 seconds ago" string, specify the following:

- On the **Basic** tab, select SECONDS sec[s] ago in the **Pattern** field and now() in **Relative To**.
- On the **Advanced** tab, select Past date in the **Direction in time** list.
The step then subtracts 123 seconds from the current time.

Example: Relative Date Patterns

Format Pattern	Matching Dates
HOURS hour[s] ago	4 hours ago an hour ago (if constant an = 1 is defined)
HOURS hour[s] and MINUTES minute[s] ago	3 hours and 5 minutes ago

Format Pattern	Matching Dates
[HOURS hour[s]]MINUTES minute[s] ago	4 hours 1 minute ago 15 minutes ago

Extract List

The Extract List data converter filters texts according to a pattern, and returns a concatenated text of all matches.

Whereas the [Advanced Extract](#) data converter only matches the first instance of the pattern, this data converter will return each possible match in succession.

Note that the pattern must not necessarily match the entire input text, which is a requirement for the Advanced Extract data converter. In fact, most uses of this data converter will utilize patterns that start and end at well-defined points (i.e. the pattern will most likely not need to contain "."* at the beginning and end of the pattern when performing a match for specific text embedded within a large input text).

Properties

The Extract List data converter can be configured using the following properties:

Pattern

Enter a pattern that is matched against the input.

Ignore Case

If this is checked, the matching against the pattern is done without regard for the character case, e.g. "KaPoW" is considered equivalent to "KAPOW" and "kapow".

Output Expression

Enter an expression that specifies the output text.

Output Delimiter

Enter an optional text to indicate the delimiter that should be used to separate successive pattern matches within the output text.

Description

Type in a description to be shown in the list of data converters. If there is no type in a description, one will be generated.

Extract Number

This data converter finds and extracts a number and outputs it in the standard number format.

Note: If a number that is already in the standard number format should be reformatted, use the [Format Number](#) data converter instead.

Properties

The Extract Number data converter is configured using the following properties:

Format Pattern

Contains a pattern that specifies the format of the number to be extracted. Either use one of the default patterns, or see below for details about specifying a pattern.

Decimal Separator

Contains the possible decimal separators in the number to be extracted, e.g. ".". More than one separator can be specified.

Thousands Separator

Contains the possible thousands separators in the number to be extracted, e.g. ",". More than one separator can be specified.

Minus Sign

Contains the character to use as minus sign in the number, typically '-'.

Multiply By

Specifies a multiplication factor that will be multiplied to the extracted number.

Convert to Integer

If this field is checked, the extracted number will be converted to an integer.

Constants

Contains definitions of *constants* which may occur before or after the number to be extracted. For each constant, the name (e.g. kilo) and the value (e.g. 1000) can be given as well as the position of the constant (before and/or after the number to be extracted). Note that the name of a constant must be precisely what comes before or after the number to be extracted. For instance, let the constants configured be kilo=1000.0 and double=2.0. From the input "2 kilo", the number 2000.0 will be extracted, but from the input "2 double kilo", only the number 2.0 will be extracted since no constants are named double kilo.

Description

Type in a description to be shown in the list of data converters. If there is no type in a description, one will be generated.

Specifying a format pattern

The format pattern provides a very flexible way of specifying the number format. However, the rules for specifying the pattern can be somewhat difficult to understand, so finding the default pattern that matches the required format in the best possible way, and then experimenting with changing that default pattern might be an easier solution.

In a pattern, the following special characters can be used:

Special Character	Description
0	A digit.
#	A digit, but zero is not shown.
.	The decimal separator, i.e. the character specified in the Decimal Separator field.
,	The thousands separator, i.e. the character specified in the Thousands Separator field.
-	The minus sign, i.e. the character specified in the Minus Sign field.

Special Character	Description
E	In scientific notation, separates the mantissa and the exponent.

Note In the pattern, the '.' character is always used to select the decimal separator, regardless of what is entered in the Decimal Separator field. The '.' character will then be replaced by the character in the Decimal Separator field when the number is formatted. The same applies to the thousands separator and minus sign.

Separate patterns can be specified for positive and negative numbers. This is done by specifying two patterns separated by semicolon (;). For example, use the pattern "#,###0.00;(#,###0.00)" if you want negative numbers to be parenthesized instead of the default where the minus sign character is placed in front of negative numbers.

Note If the input uses scientific notation with a large exponent (e.g. the number 6.023E23), Convert to Integer should generally *not* be checked, since conversion of such large numbers to integers may give inappropriate results.

Example: Extracting Numbers

Consider this input:

```
Price is USD 33,555.77.
```

WithFormat Pattern set to "###0.0", Decimal Separator set to ".", Thousands Separator set to ",", Minus Sign set to "-", Multiply By set to "1.0", Convert to Integer not checked, and no Constants configured, the number 33555.77 is extracted.

In the example above, if Convert to Integer is checked, the number 33556 is extracted.

Now, consider this input:

```
Price is USD 10.5 mill.
```

WithFormat Pattern set to "0.000", Decimal Separator set to ".", Thousands Separator set to ",", Minus Sign set to "-", Multiply By set to "1.0", Convert to Integer checked, and Constants set to mill.=1000000.0 and bill.=1000000000.0, the number 10500000 is extracted.

In the example above, if Convert to Integer is not checked, the number 1.05E7 is extracted.

Extract Year

The Extract Year data converter extracts a year from a date in the input text. The date may be incomplete, such as containing only the year.

Properties

The Extract Year data converter is configured using the following properties:

Locale

Specifies the locale that is used in the date.

Date Format Pattern

Contains a pattern that specifies the format of the date from which the year should be extracted. See the syntax description below.

Max. Months Ahead

The maximum number of months to look ahead. This field takes effect only in the absence of an explicit year when using the 'dd' and 'MM' patterns.

Max. Days Ahead

The maximum number of days to look ahead. This field takes effect only in the absence of an explicit month when using the 'dd' and 'yyy' patterns.

Description

Type in a description to be shown in the list of data converters. If there is no type in a description, one will be generated.

Syntax of the Date Format Pattern

The following patterns can be combined to create the pattern in the Date Format Pattern property:

Pattern	Description
yy	Exactly two digit year
yyy	Any year
yyyy	Exactly four digit year
MM	One or two digit month, abbreviations or full names of months
dd	One or two digit date
EEE	Short weekday name (e.g. Mon instead of Monday).
EEEE	Full weekday name (e.g. Monday).
hh or HH	One or two digit hour
mm	One or two digit minute
ss	One or two digit second
a	AM or PM marker
Z	Time Zone identifier (e.g. "PST", "Central European Time" or "GMT +02:00").
*	Skip any number of characters (this must be used in order to skip alphanumeric characters a-z and A-Z)
Space	Skip one or more white spaces
Any other non-alphanumeric character	Skip that exact character (use * to skip alphanumeric characters)

If the weekday patterns ('EEE' and 'EEEE') are used and the date pattern ('dd') is *not* used, then the month and year patterns ('MM' and 'yy'/'yyy'/'yyyy') cannot be used. In this case, the date found is the next day with a name matching the pattern. For example, if the pattern is 'EEEE' and the input is the following text:

Wednesday

the year found is the year of the next Wednesday.

If the weekday patterns are used together with the date pattern (and possibly the month and year patterns), the weekday is discarded. For example, if the pattern is 'EEE, dd/MM/yyyy' and the input is the following text:

the year found is '2003'.

Note The 'EEE' pattern matches the short names of the weekdays (e.g. Mon, Tue etc.). If the pattern should match the *entire* weekday name, use the 'EEEE' pattern. For example, if the input is the following text:

Thus, let us meet on Wednesday

the pattern 'EEEE' should be used, since the pattern 'EEE' would match 'Thu' causing the Extract Year data converter to find the year of the next Thursday.

Example: Date Format Pattern

Here are some examples of format patterns and matching dates:

Date Format Pattern	Matching Dates
dd/MM-yyy	7/6/1978 24/12-2001 1-Jan-01
dd. MM yyy	4. jan 1993 4. january 93

Format Date

This data converter reformats a date. The input text must be a date in the standard date format, e.g. "2001-02-25 14:32:49.0".

Note: If you want to convert a date to the standard date format, use the [Extract Datedata](#) converter.

Properties

The Format Date data converter is configured using the following properties:

Locale

This field specifies the *locale* that the date is to be formatted to.

Format Pattern

Contains a pattern that specifies the format of the date. Either use one of the default patterns, or see below for details about specifying a pattern.

Description

Type in a description to be shown in the list of data converters. If there is no type in a description, one will be generated.

Specifying a format pattern

The format pattern provides a very flexible way of specifying the date format. However, the rules for specifying the pattern can be somewhat difficult to understand, so it might be easier to simply find the default pattern that matches the required format best, and then experiment with changing that default pattern.

In a pattern, the following special characters can be used:

Special Character	Description	Type	Example
y,yy,yyy	year	Number	96
yyyy	year	Number	1996
M	month	Number	7
MM	month	Number	7
MMM	month	Text	Jul
MMMM	month	Text	July
d,dd	day in month	Number	10
(d)ddd	day in month	Number	(0)010
E,EE,EEE	day in week	Text	Tue
EEEE	day in week	Text	Tuesday
D,DD,(D)DDD	day in year	Number	(0)189
(F)F	day of week in month	Number	(0)2 (2nd Wed in July)
w,(w)ww	week in year	Number	(0)27
(W)W	week in month	Number	(0)2
(H)H	hour in day (0-23)	Number	(0)4 or (0)12
(k)k	hour in day (1-24)	Number	(0)4 or (0)12
(K)K	hour in am/pm (0-11)	Number	(0)0
(h)h	hour in am/pm (1-12)	Number	(0)5 or (0)12
(m)m	minute in hour	Number	(0)30
(s)s	second in minute	Number	(0)55
S,SS,(S)SSS	millisecond	Number	(0)978
a	am/pm marker	Text	PM
z,zz,zzz	time zone	Text	PST
(z)zzzz	time zone	Text	Pacific Standard Time
G	era designator	Text	AD
'	start/end of text not in input	Delimiter	'o'clock' -> o'clock
"	single quote	Literal	"EEEE" -> "Friday"

Any characters in the pattern that are not letters in the range A-Z or a-z will be treated as text. For instance, characters like ':', ',', '#', and '@' will appear in the resulting date even though they are not enclosed in single quotes.

If the pattern is empty, the default date format for the selected locale is used.

Example: Output Dates

Examples of output dates if the locale is "English (United States)":

Format Pattern	Example of output data
yyyy.MM.dd G 'at' hh:mm:ss z	1996.07.10 AD at 15:08:56 PDT
EEE, MMM d, 'yy	Wed, July 10, '96
h:mm a	12:08 PM
hh 'o'clock' a, zzzz	12 o'clock PM, Pacific Daylight Time
K:mm a, z	0:00 PM, PST
yyyyy.MMMMM.dd GGG hh:mm aaa	1996.July.10 AD 12:08 PM

Format HTML

This data converter reformats (pretty-prints) the input HTML text.

Properties

The Format HTML data converter can be configured using the following properties.

Allow Missing End Tags

If selected, tags whose end tags are optional (e.g. <p>-tags) will be ended automatically. Selecting this option is not necessary for HTML outputted directly from a step action.

Description

Type in a description to be shown in the list of data converters. If there is no type in a description, one will be generated.

Format Number

This data converter reformats a number. The input text must be a number in the standard number format, e.g. "12378.64".

Note: If a number should be converted to the standard number format, use the [Extract Number](#) data converter.

Properties

The Format Number data converter is configured using the following properties:

Format Pattern

Contains a pattern that specifies the format of the number. Use one of the default patterns, or see below for details about specifying a pattern.

Decimal Separator

Contains the *decimal separator* to use in the number, i.e. the separator between the integer and fraction part of the number, for example '.' or ','.

Thousands Separator

Contains the *thousands separator* to use in the number, i.e. the separator between groups of thousands in the integer part of the number, for example ',' or a space.

Minus Sign

Contains the character to use as minus sign in the number, typically '-'.

Description

Type in a description to be shown in the list of data converters. If there is no type in a description, one will be generated.

Specifying a format pattern

The format pattern provides a very flexible way of specifying the number format. However, the rules for specifying the pattern can be somewhat difficult to understand, so simply find the default pattern that matches the required format best, and then experiment with changing that default pattern.

In a pattern, the following special characters can be used:

Special Character	Description
0	A digit.
#	A digit, but zero is not shown.
.	The decimal separator, i.e. the character specified in the Decimal Separator field.
,	The thousands separator, i.e. the character specified in the Thousands Separator field.
-	The minus sign, i.e. the character specified in the Minus Sign field.
E	In scientific notation, separates the mantissa and the exponent.

Note In the pattern, the '.' character is always used to select the decimal separator, regardless of what have been entered in the Decimal Separator field. The '.' character will then be replaced by the character in the Decimal Separator field when the number is formatted. The same applies to the thousands separator and minus sign.

Separate patterns can be specified for positive and negative numbers. This is done by specifying two patterns separated by semicolon (;). For example, the pattern "#,##0.00;(#,##0.00)" can be used if negative numbers should be parenthesized instead of the default where the minus sign character is placed in front of negative numbers.

Get Property

This data converter fetches the value of a property from a property list contained in a variable.

The variable must be of the Properties variable type.

The input text to the data converter is ignored.

Properties

The Get Property data converter is configured using the following properties:

Properties Variable

The variable containing the list of properties.

Property Name

The name of the property to get.

Use Default Value If No Property

Determines what to do if the property does not exist. If this option is selected, a default value is used instead; otherwise an error is generated.

Default Value

The default value to use if the property does not exist, and a default value should be used instead.

Description

Type in a description to be shown in the list of data converters. If there is no type in a description, one will be generated.

Get Time Between Dates

This data converter provides the possibility to find the difference between two dates. It compares the date in the input text to a given date and calculates the difference.

The difference is measured in a selected unit, e.g. days or weeks. The input text must be a date in the standard date format, e.g. "2001-02-25 14:32:49.0".

Properties

The Get Time Between Dates data converter is configured using the following properties:

Other Date

Specify the date to compare the input date with. The date can be specified in several ways using a Value Selector. The date must be in the standard date format, e.g. "2001-02-25 14:32:49.0".

Get Difference as

Select what unit to get the difference in.

Get Integer Difference

Determines whether the difference should be rounded to an integer.

Get Signed Difference

Determines whether the difference should be with or without sign. If the difference should be signed, it will be positive if the input date is after the other date, and negative in the opposite case.

Description

Type in a description to be shown in the list of data converters. If there is no type in a description, one will be generated.

Example

If the input to the converter is "2008-03-01 12:00:00.0", and the other date is set to "2008-02-28 00:00:00.0", and the difference should be in days and with fraction, the result will be 2.5. Notice how the converter accounts for the leap year.

Get Variable

This data converter fetches the value of a variable. The input text is ignored.

Properties

The Get Variable data converter is configured using the following properties:

Variable

The variable whose value to get.

Description

Type in a description to be shown in the list of data converters. If there is no type in a description, one will be generated.

If Then

The If Then data converter allows for specification of a list of if-then rules that determine the output of the converter.

The list can consist of multiple if conditions and has always one else block at the bottom, which provides the default value.

Basic Conditions

If Contains, If Does Not Contain, If Starts With, and If Ends With condition types provide a check into whether the input string contains, does not contain, starts with or ends with the given string accordingly.

If Matches Pattern and If Does Not Match Pattern condition types provide a check into whether the input string matches or does not match a pattern.

Properties for Basic Conditions

The basic conditions of the If Then data converter can be configured using the following properties.

If Contains

If Does Not Contain

If Starts With

If Ends With

A text value is entered which is matched against the input text.

If Matches Pattern

If Does Not Match Pattern

In these fields a pattern is entered which is matched against the input text. Note that the entire input text must match / not match the pattern.

Then

Specifies the output text if the value of the property above matches the input text. The value can be specified in several ways using a Value Selector (without converters).

Ignore Case

If this is checked, the matching against the value of the first property is done without regard to the character case, e.g. "KaPoW" is considered equivalent to "KAPOW" and "kapow".

Properties for Else

The else statement of the If Then data converter can be configured using the following property.

Then

Specifies the output text if no conditions matched the input text. The value can be specified in several ways using a Value Selector (without converters). If this field is left blank, then the If Then converter returns an empty text.

In the If Matches Pattern the expression in the Then attribute can refer to submatches of the pattern in the preceding If Matches Pattern field using the \$n notation.

In all the other conditions the INPUT keyword can be used to refer to the input text.

Other Properties

The If Then data converter can additionally be configured using the following properties:

Description

Type in a description to be shown in the list of data converters. If there is no type in a description, one will be generated.

Examples

Let us assume that the input text is "911" and we want the output text to be "Porsche 911". Alternatively, if the input text is anything other than "911", it should remain as is.

The If Then data converter should then be configured as follows:

- If Matches
 - If Matches: 911
 - Then (expression): "Porsche " + \$0
 - Ignore Case: [unchecked]
- Else
 - Then (expression): \$0

Make URL Absolute

The Make URL Absolute data converter converts a relative URL to an absolute one using the current URL of the robot.

Properties

The Make URL Absolute data converter can be configured using the following properties:

Description

Type in a description to be shown in the list of data converters. If there is no type in a description, one will be generated.

Examples

In these examples, the current URL of the robot is `http://www.kapowtech.com`

- If the input text is `'~hello'`, then the output text becomes `'http://www.kapowtech.com/~hello'`
- If the input text is `'hello'`, then the output text becomes `'http://www.kapowtech.com/hello'`
- If the input text is `'test1/test2/../test'`, then the output text becomes `'http://www.kapowtech.com/test1/test'`

Make URL Relative

The Make URL Relative data converter converts an absolute URL to a relative one using the current URL of the robot.

Properties

The Make URL Relative data converter can be configured using the following properties:

Base URL

The URL to make the input URL relative to.

Description

Type in a description to be shown in the list of data converters. If there is no type in a description, one will be generated.

Examples

In these examples, the current URL of the robot is `http://www.kapowtech.com`

- If the input text is `'http://www.kapowtech.com/~hello'`, then the output text becomes `'~hello'`
- If the input text is `'http://www.kapowtech.com/hello'`, then the output text becomes `'hello'`
- If the input text is `'http://www.kapowtech.com/test1/test2/../test'`, then the output text becomes `'test1/test'`

Modify Date

This data converter modifies a date by adding or subtracting from a selected part of the date.

If the addition/subtraction causes the selected part of the date to overflow or underflow, the other parts of the date will be updated accordingly.

The input text must be a date in the standard date format, e.g. `"2001-02-25 14:32:49.0"`.

Properties

The Get Time Between Dates data converter is configured using the following properties:

Amount

The amount to add or subtract from the date. The amount is specified using a Value Selector. The value must be an integer.

Part of Input Date to Modify

Select which part of the date to add or subtract from.

Function

Choose if the amount should be added or subtracted.

Time Zone

The time zone of the input date.

Description

Type in a description to be shown in the list of data converters. If there is no type in a description, one will be generated.

Example

If the input to the converter is "2008-02-28 10:45:00.0" and two days should be added, the result will be "2008-03-01 10:45:00.0". Notice how the month was updated and the leap day in 2008 was taken into consideration.

Remove Non-Printable Characters

The Remove Non-Printable Characters data converter removes all non-printable characters.

More specifically, the following characters are removed:

- All characters below ASCII 32, except tab (#x0009), line document (#x000A), and carriage return (#x000D).
- All characters in the intervals #xD800-#xDFFF and #xFFFE-#xFFFF.

Properties

The Remove Non-Printable Characters data converter can be configured using the following properties:

Description

Type in a description to be shown in the list of data converters. If there is no type in a description, one will be generated.

Remove Spaces

This data converter removes spaces from the input text. Notice that non-breakable spaces (occur as in the HTML) are treated as spaces.

Properties

The Remove Spaces data converter can be configured using the following properties.

Remove All Spaces

Removes all spaces from the input text.

Remove Start and End Spaces

Trims the text so that there are no spaces at its start and end.

Replace Multiple Spaces with Single Spaces

Replaces all occurrences of multiple spaces within the input text with single spaces.

Description

Type in a description to be shown in the list of data converters. If there is no type in a description, one will be generated.

Example

If the input text is:

```
"  hello  world  "
```

and Replace Multiple Spaces with Single Spaces is selected, then the output text becomes:

```
" hello world "
```

With Remove Start and End Spaces selected, the output text becomes:

```
"hello  world"
```

With both Replace Multiple Spaces with Single Spaces and Remove Start and End Spaces selected, the output text becomes:

```
"hello world"
```

And with Remove All Spaces selected, the output text becomes:

```
"helloworld"
```

Remove Special Characters

The Remove Special Characters data converter replaces all special characters with spaces in the input text. Any character that is not a letter, a digit, or a comma/point appearing before a digit, is considered to be a special character and is replaced by a space.

After applying the Remove Special Characters data converter, the [Remove Spaces](#) data converter can be used to remove undesired spaces.

Properties

The Remove Special Characters data converter can be configured using the following properties:

Description

Type in a description to be shown in the list of data converters. If there is no type in a description, one will be generated.

Remove Tags

The Remove Tags data converter removes HTML tags from the input text.

Properties

The Remove Tags data converter can be configured using the following properties.

Remove These Tags

Specifies the tags that should be removed.

- "All Tags" specifies that all tags should be removed. Optionally keep ampersand encodings in the text.
- "Selected Tags" specifies that only the selected tags should be removed. The tags names are separated using commas, e.g. "html,body". Optionally keep ampersand encodings in the text.

Description

Type in a description to be shown in the list of data converters. If there is no type in a description, one will be generated.

Replace Pattern

The Replace Pattern data converter replaces matches of a [pattern](#) with the result of an [expression](#).

Properties

The Replace Pattern data converter can be configured using the following properties.

Pattern

Specifies a pattern to search for in the input text. Note that this pattern does not have to match the entire input text.

Ignore Case

If this is checked, then the pattern matching is case-insensitive.

Replace Expression

Specifies an expression, whose result will replace the part of the text matched by the pattern.

Replace All

If this is checked, then all occurrences of the Pattern will be replaced by the Replace Expression. If not, then only the first occurrence is replaced.

Description

Type in a description to be shown in the list of data converters. If there is no type in a description, one will be generated.

Replace Text

This data converter finds and replaces matching text in the input text.

Properties

The Replace Text data converter can be configured using the following properties.

Find this Text

The text to search for in the input text.

Replace with this Text

The text to replace with.

Ignore Case

If this is checked, then the text matching is case-insensitive.

Replace All

If this is checked, then all occurrences of the text will be replaced by the new text. If not, then only the first occurrence is replaced.

Match Whole Words Only

If this is checked, then text replacement will only take place for occurrences that are whole words and not parts of larger words.

Description

Type in a description to be shown in the list of data converters. If there is no type in a description, one will be generated.

Unquote Text

This data converter unquotes text that is enclosed in single or double quotes. Escaped quotes inside the text are unescaped.

Properties

The Unquote Text data converter can be configured using the following properties.

Description

Type in a description to be shown in the list of data converters. If there is no description, one will be generated.

Examples

If the input text is:

```
"Bob"
```

then the output text becomes:

```
Bob
```

If the input text is:

```
"Robert \"Bob\" Jones"
```

then the output text becomes:

```
Robert "Bob" Jones
```

If the input text is:

```
'Bob'
```

then the output text becomes:

```
Bob
```

If the input text is:

```
Bob
```

then the output text becomes:

```
Bob
```

URL Decode

This data converter decodes all URL encodings into their real characters.

The encoded characters are on the form %HH, where HH is the hexadecimal byte value. The encoded characters are first decoded to bytes from this notation. The bytes are then converted to characters using the selected character encoding.

Properties

The URL Decode data converter can be configured using the following properties:

Character Encoding

The character encoding to use for converting the bytes to characters.

Description

Type in a description to be shown in the list of data converters. If there is no type in a description, one will be generated.

Example

If the selected character encoding is UTF-8, and the input text is:

```
x%2By%3Dz
```

the data converter will output:

```
x+y=z
```

URL Encode

This data converter encodes characters with URL encodings.

The characters that need to be encoded are first converted to bytes using the selected character encoding, and the bytes are then represented on the form %HH, where HH is the hexadecimal byte value.

Properties

The URL Encode data converter can be configured using the following properties:

Character Encoding

The character encoding to use for converting the characters to bytes.

Description

Type in a description to be shown in the list of data converters. If there is no type in a description, one will be generated.

Example

If the selected encoding is UTF-8, and the input text is:

```
x+y=z
```

the data converter will output:

```
x%2By%3Dz
```

The Type Editor

The Type Editor is used for writing and maintaining types that are used in [Design Studio](#). With the Type Editor, you can easily create and configure new types.

This section provides help on the user interface features of the Type Editor of Design Studio, including detailed explanations of types and attribute configurations.

For more detailed information about the Type Editor, please consult the [Design Studio User's Guide](#).

Type Configuration

In the main view of the Type Editor, the various properties of a type can be edited. This includes the attributes of the type, the type kind, a comment attached to the type (optional) and a storage name (optional).

A type must have a valid name. This name is simply the file name of the corresponding type file. This name must contain only letters, digits, and underscores, and must begin with a letter or an underscore. Additionally, it must be unique in the project. The name of a type is used as storage name unless a storage name has been specifically configured (see below).

A type contains the following properties which can be configured in the Type Editor:

Attributes

The attributes that are added to the type are shown in the table. To add a new attribute, click the 'Add and Configure New Attribute' button below the table. To remove an attribute, select the row with the attribute, and click the 'Remove Attribute' button. To configure an attribute, click the 'Configure Attribute' button. When you add or configure an attribute, the [Attribute Configuration](#) dialog will automatically pop up. Note that to conserve space, not all columns in the table are shown by default. To change which columns are shown, right-click on any of the column names.

Type Kind

The type kind selection of a type is available for legacy purposes. Normally, the 'Standard Type' type kind should simply be used, meaning it is not necessary to configure this property. The drop-down allows the following selections

- Standard Type indicates that the type is a standard type.
- Database Output Type (Legacy) indicates that the type is a Database Output type. This is a special type required when storing data in a database created with versions of Kapow prior to 7.2. This type

kind exists only for backwards compatibility purposes. Database Output types require at least the following attributes with the indicated attribute types:

Attribute Name	Attribute Type
robotId	Integer
robotRunId	Integer
refindKey	Refind Key
firstExtractionDate	Date
latestExtractionDate	Date
extractedInLatestRun	Boolean

These attributes are required because when a value extracted from a variable of a database output type is persisted to storage, Kapow will try to find a value with the same 'refindKey' in the database. If such a value exists, it will be updated, and if not, the extracted value will be inserted. The 'firstExtractionDate' is the date and time when the value was extracted for the first time, and the 'latestExtractionDate' is the date and time when the extracted value was inserted or updated for the last time. The 'extractedInLatestRun' will be 'true' if the value was extracted in the latest robot run. If some of these required attributes are missing from a database output type, the type will not be valid. The Type Editor will warn you if this is the case, and provide you with the possibility of adding the missing attributes.

Comment

Here you can add an optional comment to the type. The comment is only displayed in the Type Editor.

Storage Name

Here you can set a name to use when storing values from variables of this type, e.g. the table name in a database, or the tag name in XML. If you leave this field blank, the name of the type will be used instead for storage. The intended use of the type may put some constraints on the storage name; for example, if values of the type are going to be stored in a database, you must avoid using a storage name which is the same as some keyword in the database you intend to use.

Attribute Configuration

Here you can add an optional comment to the type. The comment is only displayed in the Type Editor.

Basic Tab

This tab contains the basic properties of an attribute.

Name

The name of the attribute. The name must be unique within the type. Also, the name must contain only letters, digits, and underscores, and must begin with a letter or an underscore. Additionally, if no Storage Name is set on the attribute, the Name will be used as Storage Name (row name in a database, column header in a CSV file, or tag name in XML). Depending on the intended use of the type, this may impose additional constraints on the name; for example, you may have to avoid naming the attribute the same as a keyword in the database you intend to use.

Attribute Type

Choose the attribute type of the attribute from the list of [attribute types](#).

Default Value

Set the default value for the attribute.

Required

If checked, this option serves two purposes:

- Variables of the type will not be stored (in a file or database) if the attribute doesn't have a value.
- Input variables of the type must have a value for the attribute or the robot execution will not start.

Comment

In this field you can add an optional comment for the attribute, which can be helpful for describing the attribute in detail.

Advanced Tab

This tab contains the advanced properties of an attribute.

Storage Name

This is an optional different name to use when storing the attribute, e.g. the row name in a database, the column header in a CSV file, or the tag name in XML. If you leave this field blank, the value from the Name property will be used automatically for storage. The intended use of the type may put some constraints on the storage name; for example, if values of the type are going to be stored in a database, you must avoid using a storage name which is same as a keyword in the database you intend to use.

Visible

Select this option if the attribute should be visible in robots in Design Studio.

Storable

Select this option if this attribute should be stored when storing values of the type.

Part of Database Key

When storing values of a type in a database they need to be stored under a key. The key for the value is calculated as a secure hash of the attributes that are part of the database key. Choosing a good key is important when storing values in a database. You should make sure that the key attributes you select are unique across all the values of the type. Good examples of keys are product numbers and URLs. If you have stored data in the database, you should be very careful when changing this option. Any change will cause all the robots to be unable to refind (update) existing values in the database. If you have the correct setting for most of your robots but a single robot requires a different key calculation then you should change the key field on the steps in the robot.

Show Separator Before

This option is marked if a separator should be shown before this attribute when the type is used in robots in Design Studio.

Separator Title

The name of the separator.

Attribute Types

The following attribute types are available:

Integer

An integer, e.g. 12.

Number

A number, e.g. 12.345.

Boolean

A boolean value, i.e. either "true" or "false".

Short Text

A short text. Kapow will display a Short Text attribute in a one-line text field.

Character

A single character, e.g. "A".

A long text.

A long text. Kapow will display a Long Text attribute in a multi-line text box.

Password

A password text. Kapow will display a Password attribute in a password field that shows asterisks instead of the characters in the password.

HTML

An HTML clip. This is the same as a Long Text, except that you can preview the clip in a browser window.

XML

An XML document. This is the same as a Long Text, except that only well-formed XML documents are allowed.

XML

An XML document. This is the same as a Long Text, except that only well-formed XML documents are allowed.

Date

A date. The date must be on the form yyyy-mm-dd hh:mm:ss.n, e.g. "1992-04-25 10:33:06.0".

Binary

Binary data, i.e. any sequence of bytes.

Image

An image. This is the same as Binary, except that you can preview the image.

PDF

A PDF document. This is the same as Binary, except that you can preview the PDF document.

Properties

A list of name/value pair properties. This is the same as a Long Text, except that the text represents a list of properties, where each property is a name/value pair. For more on this attribute type, please see [Attribute Type](#).

Session

A session consisting of a page, the page URL, the referrer URL, cookies, authentications and a time stamp.

Currency

A currency code, as defined by the ISO-4217 standard, e.g. "EUR" for Euro.

Country

A country code, as defined by the ISO-3166 standard, e.g. "DE" for Germany.

Language

A language code, as defined by the ISO-639 standard, e.g. "de" for German.

Refind Key

A special refind key used for refinding values.

JSON

A JSON value is either a JSON text or JSON Simple type where the JSON Simple type is either a JSON literal, a number, or a string.

Properties Attribute Type

An attribute of the Properties attribute type contains a text that represents a list of properties, where each property is a name/value pair.

The Properties attribute type is useful for representing a list of properties that may vary dynamically. If you have a fixed set of properties, you should normally represent each property as an attribute instead.

Here is an example of a list of properties that an attribute of the Properties attribute type can contain:

```
"productName" = "Hydraulic Valve" "productNumber" = "53563-433" "productVendor" = "American Valves Inc." "productWeight" = "3.45" ...
```

Each property must be on a separate line. A property line must consist of the property name, followed by a '=', followed by the property value. A specific property can occur at most once in the list. The name of a property cannot be empty, but the value can.

The name and value may be specified with or without quotes. When you use quotes, you can use the backslash character (\) to enter special characters:

- \n for line break.
- \r for carriage return.
- \f for form feed.
- \t for horizontal tab.
- \b for backspace.
- \" for double quote.
- \' for single quote.

- \\ for backslash itself.
- \uxxxx for the unicode character with encoding xxxx, where xxxx is four hexadecimal digits.

If you do not use quotes around the name/value, all spaces at the start and end of the name/value will be removed, you cannot specify an empty value, and you cannot use the backslash notation to enter special characters.

The list of properties can contain empty lines and comment lines. A comment line starts with two forward slash characters (//).

Creating and Deleting Tables

If you want to store your extracted variable values in a database, you will have to create matching tables. Design Studio can assist you in creating these tables.

In the Tools menu, select 'Create Database Table' to open a window where you can choose the name of your database and the type(s) that you want to create table(s) for. By clicking 'Generate SQL', you will be shown a suggestion for an SQL statement for creating the table(s). By default the 'Add Drop Table' checkbox is checked, which ensures that each 'CREATE TABLE' statement is preceded by a 'DROP TABLE' statement to make sure the corresponding table is removed if it already exists. If a table does not exist, this statement simply has no effect.

You can change the generated SQL to fit your needs before you execute it. For example, you could change the column type for a text attribute from 'VARCHAR(255)' to 'VARCHAR(50)', or you could add an auto-incrementing primary key. However, normally, you should not change the table name or any of the column names, or remove any of the columns.

Protocols

A Protocol defines a mechanism for contacting RoboServer. Currently Kapow comes with three different protocols, each with its own set of advantages and disadvantages.

Protocol	Description
Socket	Contacts RoboServer using a TCP socket. This is a simple, low-level protocol, using XML or Java binary representation depending on the platform. See description of properties below.
Random Distribution	Given a list of protocols, each time the client makes a request, one of the protocols will be chosen based on whether it is currently marked as available or not. This provides simple fail-over if at least one of the RoboServers specified in the list is available. While the random distribution protocol does not explicitly provide load balancing, it can be used for that purpose. See description of properties below.

Properties

The protocols are configured using the following properties:

Socket

Host Name

The name of the host machine RoboServer is located on.

Port Number

The port number RoboServer is listening on. The default port number is 50000.

Random Distribution Protocol

Retry If Connection Lost

Enable this option to support transparent fail-over. If the connection to a RoboServer is lost while handling a request, the protocol can re-submit the request to another RoboServer from the list. In order for this to work correctly, the robot in question must be idempotent, meaning that repeated invocations of the robot have the same effect as one. Typically this is the case with robots that do not cause permanent changes in the sites they access.

Protocols

The list of protocols to distribute requests to. The random distribution policy select a protocol at random for handling each individual request.

Depending on what plugins are installed into Kapow, other protocols may be available.

Robot Libraries

A robot library is a collection of Kapow robots and types. When RoboServer receives a request to execute a robot it will search a robot library for the robot and associated types.

Robot Library	Description
Default Robot Library	RoboServer uses its current project robot library for looking up robots and types. This is very convenient during development as every time a fix is made to a robot, the change is immediately available.
Robot Library File at URL	RoboServer loads the library from the URL once and then caches the library for a period of time. The cache timeout can be controlled by the cache-timeout attribute in the deployment descriptor. See description of properties below.
Robot Library Embedded in Request	This option embeds the robot library in all requests sent to RoboServer. RoboServer will then use this library to extract the robot and types needed to fulfill the request.
Robot Library Folder at URL	Instructs RoboServer to look up Robots relative to a specified URL. See description of properties below.

Properties

The libraries are configured using the following properties:

Robot Library File at URL

URL

Location of the packaged robot library.

Allow Caching

Enable this option to allow RoboServer to cache the robot library. If RoboServer is not allowed to cache the content of the URL, it retrieves the contents of the URL each time it receives a request. This is very useful if you have a big robot library as it reduces the time it takes to start the robot.

Cache Timeout

The number of seconds RoboServer is allowed to cache the robot library. If the Allow Caching property is not enabled, this setting has no effect.

Robot Library Folder at URL

URL

The URL to look up robots relative to.

Upload to Management Console

Publish your robot as well as the types and snippets it uses to a Management Console. This dialog box appears when you upload your files from a local non-shared project to a shared project on a Management Console. For the Management Console connection settings see [Management Console](#).

Management Console

Select one of the Management Consoles from the list. The list contains Management Consoles that your Design Studio is connected to.

Project

Select the project to upload to.

Remember (as shared project)

Select this option to link your project to the selected Management Console project.

Other Topics

This section contains reference help on some of the other important concepts that are used in the Design Studio.

Robot Configuration

A robot is configured using the properties described below.

Basic Tab

Default Options

Here, you can configure the default options for the step actions of the robot. See [Options](#) for more information.

Robot Comment

Here you can enter a comment about a robot.

Advanced Tab

Robot Id

This is a legacy property. A robot must have an id if you use the [Database Storage Environment](#) or the [Database Message Environment](#).

This property contains an optional id for the robot. This id must be unique among all robots. If you use RoboManager, then you should use that application to keep track of robot ids. You can register your robot in RoboManager and get an id for it by clicking "Register...". If you do not use RoboManager, you will have to keep track of the robot ids yourself.

Proxy Server

This property specifies an optional proxy server to use for all page and data loading done by this particular robot. You should use this property only rarely. Normally, it is better to specify one or more proxy servers for the entire Kapow installation. This is most easily done in the Kapow Settings application. See the Kapow Installation Guide for further details on this. The proxy server specified for a particular robot will override proxy servers specified any other way.

HTTP Client

The client used to make HTTP requests to remote sites.

NTLM Authentication

Kapow has built-in support for the NTLM authentication scheme over HTTP (both for proxies and target systems).

JCIFS Authentication (Classic browser only)

For Classic browser robots, in case Kapow cannot authenticate with your system, an alternative NTLM authentication engine named JCIFS is available. To use JCIFS, download the JCIFS library version 1.3.16 JAR file from <http://jcifs.samba.org> and place it in the lib folder of your Kapow installation directory and select "JCIFS" as the NTLM authentication to use in the configuration of the robot.

Enable Private HTTP Cache

Select this option to enable private HTTP caching. Pages received from a server marked with Cache-Control: private contain information specific to a particular client and are not stored in the global HTTP cache. To never cache such pages you should disable this option. To store such pages in a robot specific cache you should enable this option. The downside to enabling private HTTP caching is using more memory per robot. If you are running a large amount of robots on the same server, you can disable this option to decrease their memory footprint.

Private HTTP Cache Size

This property specifies the maximum amount of memory to use for the private HTTP cache. The size is specified in kilobytes. You should beware of setting this number high because each and every robot

instance running could potentially use this amount of memory in addition to its other state. All pages stored in the HTTP cache are compressed, so simple pages with text content will require very little memory. Also note, that only pages with Cache-Control: private or similiar will ever be stored in the private HTTP cache. Pages marked for non-private caching will go into the global HTTP cache shared by all robots.

Design Mode

Select the [Design Mode Execution](#) for your Robot. Available options are:

- Minimal Execution (Direct)
- Smart Re-execution (Full)

The **Avoid External Re-execution** option, which is available for **Smart Re-execution**, ensures that steps are never re-executed, even when the cached result of the previous execution cannot be used. This option should only be used when there are requirements from the interaction with the external world to avoid re-execution, for example if this would result in incorrect or duplicate data in a partner's system.

Version

Shows the version of the saved robot and the version of the Design Studio the Robot was last edited in.

Options

Here, you can configure additional options of the action.

All Loading Tab

This tab contains general loading properties, used for both page loading and other types of loading.

Credentials

As credentials, you can either use standard username/password credentials or OAuth credentials. If you select Standard, the following properties are available:

Username

This property specifies which username to use for login. The value can be specified in several ways using a [Value Selector](#). Note that this username is used only for HTTP and FTP based login. These types of login normally cause a pop-up window prompt in a browser, and are different from the typical and more commonly used form based method for login.

Password

This property specifies which password to use for login. The value can be specified in several ways using a [Value Selector](#). Note that this password is used only for HTTP and FTP based login. These types of login normally cause a pop-up window prompt in a browser, and are different from the typical and more commonly used form based method for login.

Alternatively, you can use OAuth credentials. OAuth is the preferred authentication mechanism for a number of popular REST APIs. Read more on how to use OAuth with Design Studio and the Management Console in the OAuth section of the documentation.

Client Certificate

This property defines where to get a client certificate when loading from HTTPS URLs. The client certificate may be given directly, or you may refer to one of those that have been installed as described in HTTPS Client Certificates. The options are:

- **Automatic** Selects that one of the installed certificates which is marked as "default". If no certificates have been installed, or none of the installed ones are marked as "default", no client certificate will be used for the connection.
- **Installed Certificate** Selects one of the installed certificates by giving its ID, which was defined when it was installed.
- **Certificate from Variable** The certificate is given as the value of a binary variable. The certificate's password must be given as well, as the value of another variable.
- **ID from Variable** Selects one of the installed certificates by giving its ID as the value of a variable.

SSL/TLS

This property specifies the version of SSL/TLS to use when loading from HTTPS URLs. This is configurable, because some sites give different results depending on the SSL/TLS version that is used, for example because they do not work with TLS or because they do not accept the weaker security that SSL provides. It is possible to select between SSLv3 or its successor TLS, or to accept both in negotiation with the site. In either case, it is possible to specify that the protocol negotiation should be initiated with SSL Hello or TLS Hello.

Verify SSL Certificates (Default browser only)

If this option is selected, the robot verifies the presented SSL certificate.

Browser to Emulate (Classic browser only)

This property specifies which browser you want the action to appear as when it loads something. Appearing as an older browser can sometimes provide you with a simpler page. However, we generally recommend that you stay with the default because this will normally cause the remote web server to serve up JavaScript etc. that is compatible with Kapow's built-in browser.

For anonymization purposes, you should rather change the "HTTP User Agent" property which is described below.

HTTP User Agent

This property specifies the exact text to send as the value of the HTTP User-Agent header. By default, the user agent header value is derived from the "Browser to Emulate". Changing the User-Agent header - perhaps in a random manner, obtaining the value from a variable - can be useful to better blend in with other requests to a remote web server.

Language

This property specifies which browser language to appear to have, both when queried by JavaScript and when loading something.

Screen Size

This property specifies which screen size to appear to have, if queried by JavaScript.

Flash Version (Classic browser only)

This property specifies which flash version to appear to support, if queried by JavaScript.

Referred from this URL

This property specifies which URL you want the action to appear to have been referred from when loading something. If you do not specify a URL, the action will appear to be referred from the current page in the robot.

Enable Cookies

This property specifies whether you want cookies to be enabled.

HTTP Cache

This property specifies how you want the robot to use HTTP caching.

Default browser engine

The default setting **Enabled** enables the HTTP Cache and caches HTTP responses based on the rules of HTTP caching. **Disabled** option disables HTTP caching. **Aggressive** option overrides cache directives and enables caching of the resources that are otherwise not cached. The Aggressive option may be helpful to boost performance of high latency sites.

Classic browser engine

The default setting is **Standard**. Standard HTTP Cache mode enables the HTTP Cache and transparently caches HTTP responses based on the rules of HTTP caching. Selecting **Force Caching of JS and CSS** will override the rules of caching and force the robot to cache JavaScripts and style-sheets, in some cases this will boost the performance of high latency sites. Selecting **Disabled** will disable all HTTP caching.

Max. Number of Attempts

This property specifies how many times you want to attempt execution of the action if a load error occurs. The minimum value is "1".

Time Between Attempts (s)

This property specifies how many seconds to wait between each attempt to execute the action.

Timeout for Each Attempt (s)

This property specifies how many seconds each attempt to execute the action is allowed to take before timing out. The value must be greater than zero.

Additional Headers to Send

This property specifies an optional variable that contains additional HTTP headers to send. The headers must be represented as a text, in the same format as in an HTTP message.

Store Received Status Code Here

This property specifies an optional variable in which to store received HTTP responses status code. The code will be an integer, and will correspond to the same response for which the received headers were obtained.

Store Received Headers Here

This property specifies an optional variable in which to store received HTTP headers. The headers will be represented as a text, in the same format as in an HTTP message.

Ignore Load Errors

This property specifies whether to ignore errors when the loading of a page or resource fails.

Page Loading Tab

This tab contains properties used specifically for loading pages.

Page Content Type

This property specifies the content type of the loaded pages. Usually, the "Automatic" setting should suffice, but you may also directly specify a content type, either for all pages loaded in the action or for only some of them, depending on their URL.

Page Content Encoding

This property specifies the character encoding of the loaded pages. The "Automatic" setting should work in most circumstances, but it may be necessary to specifically set the encoding of the pages, either for all pages and text resources (e.g. external JavaScript files) loaded in the action or for only some of them, depending on their URL.

Form Parameter Encoding

This property specifies which character encoding to use for encoding field values when submitting a form. Usually, the "Automatic" setting will be sufficient, but if you encounter problems with incorrect characters in the submitted data, you can try to set a specific encoding here.

Follow Meta Redirections

This property specifies whether to follow <meta>-tag redirections, i.e. redirections defined by a <meta> in a loaded page.

Apply XSL Style Sheets

This property specifies whether to apply referenced XSL style sheets when loading a page that contains XML. For instance, an XML document intended to be displayed in a browser can contain a reference to an XSL style sheet that transforms the XML document into HTML.

Use Preloading

Pre-load Javascript and style sheets in HTML documents, i.e. start loading the resources as soon as the HTML response from the web server is received. Enabling this option cuts down on the time that each step spends waiting for resource loads to complete because the loads are initiated before the robot reaches a state where it must block until the resources are ready.

Load Frames

This property specifies whether to automatically load the frames of a page.

Load Unsupported Formats

This property specifies whether to load the content of unsupported formats. An unsupported format is one that Design Studio cannot parse and present in the Page View, e.g. a video format. Often resources of such formats may take long to load and the robot may not be able to access the content so loading the content of the resource may just slow down the robots execution. The headers and status code are always obtained from the response even if loading of the contents is turned off. An additional use of this feature is to get the header information about a resource without loading it (in the case this is in an unsupported format). This is slightly different than just using a HEAD request, since a HEAD request only obtain the headers for the initial request and not resources obtained through META or JavaScript redirects.

Images to Load

This property specifies whether to automatically load the images of a page. Usually, it is not necessary for the robot to load the images, but you may choose to load the images of a page if you suspect that the

image loading has side-effects that are necessary for the navigation of the page. In that case, you may choose to load all of the images on the page or only some, depending on their URL.

Max. Loads Per Window

This property specifies the maximum number of page loads per window allowed in the action. This can be used for stopping the page loading if an infinite loop of redirections or reloads are encountered. Such an infinite loop will eventually cause the action to time out anyway, but by detecting this earlier, you can avoid putting excessive load on the web server that you are accessing. The action will generate an error if it stops because the maximum number of page loads has been reached.

Max. Window Nesting

This property specifies the maximum number of window allowed nested inside each other. A window in this context can mean several things. In a frameset each frame is a window, so the Max. Window Nesting property specifies how many frames a loaded page can have inside each other. The action will generate an error if it stops because the maximum number of nested windows has been reached. If you check the Ignore Load Errors option, the step action will complete successfully and output a page containing no more than the maximum number of nested windows. If you leave the field blank, there is no limit to the window nesting level.

Page Changes

This property allows you to change the loaded pages on-the-fly before they are parsed. This is useful for things like correcting syntax errors, solving other parsing problems, removing or changing tags, and so on.

The changes are done by specifying one or more [data converters](#) that will be applied to the pages before the parsing. You can either specify data converters to apply on all pages, or data converters to apply to individual pages depending on their URL.

The most common data converters to use for page changes are Replace Text, Replace Pattern, and Remove Tags. When configuring the data converters, remember that they will be applied to the original, unprocessed text of the page, before decoding of ampersand encodings etc. Therefore, it is recommended that you obtain this text, e.g. using the View Source function of your standard browser. In the data converter configuration window, you can paste the text into the input area in the lower left corner and click the Test button to test that the converter performs the desired action on the text.

Note that if you want to make changes to JavaScript, use the JavaScript Changes property on the JavaScript Execution tab instead.

Page Error Test

This property specifies a custom test for website errors based on the content of the page. Usually, a website will send an error code when something goes wrong, but if this is not sufficient to detect errors, this property can be used.

If Same for All Pages is selected, the test is performed on all pages. By selecting Depends on URL, you may set up individual tests for particular (groups of) URLs.

You can specify a pattern that matches an error page (by selecting Pattern Matches Rejected Page), or you can specify a pattern matching all other pages (by selecting Pattern Matches Accepted Page).

Output Page If Error

This property specifies whether or not to output a page even if the website sends an error code. If disabled, any website error will cause the action to fail. If enabled, certain website errors are accepted and the page is output, whereas all other server errors will still cause the action to fail. The accepted website errors are 403 Forbidden, 404 Not Found, and 500 Internal Server Error.

Output Page If Timeout

This property specifies what occurs when the action times out. If disabled, the action fails in the event of a timeout. If enabled, the result received so far is the output. Note the following for this property:

- When older Default browser (WebKit) robots that have **False** as default for this property are opened in a new version of Kapow, "Output Page If Timeout" is set to **False** in the robot's browser configuration.
- When creating a new Default browser robot, the "Output Page If Timeout" property is set to true by default.
- When creating a new Classic browser robot, the "Output Page If Timeout" property is set to false.

URL Filtering Tab

This tab controls the configuration of what URLs to block, for instance to block the loading of ad frames.

Filter URLs

This property specifies whether to block loading of certain URLs. The URLs to be blocked are specified as [pattern](#) in the list of Included URL Patterns and Excluded URL Patterns, respectively. Only URLs occurring in the following tags may be blocked:

Included URL Patterns

If specified, only URLs that match these patterns will not be blocked. Each pattern must be written on a separate line. A URL that matches one of these patterns may still be blocked, if it matches one of the "Blocked URL Patterns" specified below. A typical use of this property is to specify a pattern that matches only URLs of a single domain, so that only frames and scripts from that domain are loaded.

- `<frame src="URL">`
- `<iframe src="URL">`
- `<script src="URL">`

If a URL is blocked no request is performed and content is left empty. In the case of frame and iframes there will still be a new window in the page view and this will be showing a message explaining why the load was not performed. An icon on the tab of the window in the page view will indicate that the URL was blocked.

Blocked URL Patterns

This property specifies which URLs to block. This is specified by writing a list of patterns with one pattern on each line.

JavaScript Execution Tab

This tab contains properties used for executing JavaScript. These properties allow you to customize the JavaScript execution in case the default automatic execution does not work correctly. Note that using the options of the Logging tab, the Log window in Design Studio can provide information about the JavaScript execution performed during execution of the robot. You can use this window to understand which JavaScripts are executed, which errors occur, and so on.

Note Some of the properties on this tab differ in the Default and Classic browser engines.

Execute JavaScript

This property specifies whether JavaScript should be executed.

Ignore JavaScript Errors (Classic browser only)

This property specifies whether errors that occur during JavaScript execution should be ignored. In many cases, such errors can safely be ignored, as long as the outcome of the execution is as desired.

Ignore Alert Messages

If checked, an alert message produced by the JavaScript method `alert()` will be ignored, otherwise an error will be generated. Alert messages are typically created by JavaScript to alert the browser user of an invalid action, such as trying to submit a form that is not correctly filled out.

A common way to handle alert messages in a robot is to configure this property to ignore them, and then configure the Store Ignored Alert Messages Here property below so that ignored alert messages are stored in an appropriate variable. In a subsequent step, this variable can then be tested and suitable action taken if it contains an alert message.

Store Ignored Alert Messages Here

This property specifies a variable in which ignored alert messages should be stored. This is relevant only when the Ignore Alert Messages option has been selected above.

Enable Timer Events (Classic browser only)

This property specifies whether timer events should be executed. Timer events are events that occur after a specified amount of time and can be set up either by JavaScript using `setTimeout()` or `setInterval()` or when a `<meta>` redirection specifies that the page should be redirected after a number of seconds.

Max. Wait for Timer Events (ms) (Classic browser only)

This property specifies the maximum number of milliseconds to wait for timer events to be executed, since the beginning of the execution of the action. For example, if a page loads in 3000 ms and sets up some timer events, and this property has been set to 30000 ms, only timer events that expire within 27000 ms after the page load will be executed. Note that the wait for the timer events is done either in real-time or just emulated, depending on the Wait Real-Time for Timer Events property below.

Wait Real-Time for Timer Events (Classic browser only)

This property specifies whether to actually wait the time specified by the Max. Wait for Timer Events property above, or to just emulate the wait and execute any triggered timer events immediately. For many timer events, it is not necessary to actually wait the period specified, and thus the robot can immediately proceed. However, if the reason for the timer event is that e.g. one must wait for the web server to process results, it may be necessary to wait real-time.

Delay Between Key Presses (ms)

This property specifies the amount of milliseconds to wait between key presses when emulating a user typing on a keyboard. This only has relevance for step actions that enter text into a form.

Use CSS Style Sheets (Classic browser only)

This property specifies whether to load and parse CSS style sheets during the execution of the robot. This may be necessary for the JavaScript on a page to work correctly. On the other hand, disabling the use of style sheets can speed up the execution of page loads. Even if this option is disabled, the page view may

still load style sheets for display purposes, but this loading will not take place when the robot runs on the server.

JavaScript Changes

JavaScript changes are an optional list of [data converters](#) that will be applied to the JavaScript before it is executed. The changes are applied to all JavaScript that is executed, both event handlers, internal and external scripts. The data converters are useful for making changes and corrections to the JavaScript. For example, they can be used to define variables that the JavaScript expects to have been defined by VBScript. The most common data converters to use for this purpose are Replace Text and Replace Pattern.

When configuring the data converters, remember that they will be applied to the original JavaScript. Therefore, it is recommended that you obtain this text, e.g. using the View Source function of your standard browser for inline JavaScript or by downloading the file in case of external JavaScript. In the data converter configuration window, you can paste the text into the input area in the lower left corner and click the Test button to test that the converter performs the desired action on the text.

Important This option affects the way JavaScript is executed on pages that you load, that is the option is applicable to Load Page and Create Page steps.

Plugins

This tab contains parameters to add and configure simulated plugins when using the browser.

Simulate support for

- **From List:** Click the plus sign and select a plugin from the list.
- **From JSON Variable:** Construct your own plugins using a JSON variable.
See [Plugin Simulation from JSON Variable](#) for more details.

Javascript Event Handlers Tab

This tab contains properties that determine which JavaScript event handlers should be executed. Note that using the options of the Logging tab, you can obtain information about which event handlers are executed during execution of the robot, in the Log window in Design Studio.

Enable Click Event Handlers

This property specifies whether onclick event handlers, if any, are executed when clicking a tag.

Enable Change Event Handlers

This property specifies whether onchange event handlers, if any, are executed when modifying a value in a form.

Enable Form Event Handlers

This property specifies whether the onsubmit and onreset event handlers, if any, are executed when submitting or resetting a form, respectively.

Enable Load Event Handlers

This property specifies whether the onload and onunload event handlers, if any, are executed when loading / unloading a page or loading an image.

Enable Mouse Event Handlers

This property specifies whether the onmouseover, onmouseenter, onmouseleave, onmousedown and onmouseup event handlers, if any, are executed when moving the mouse over or clicking a tag.

Enable Drag Event Handlers

This property specifies whether the ondrag, ondragstart, ondragenter, ondragleave, ondragend and ondragover event handlers, if any, are executed when the mouse is dragged over a tag.

Enable Key Event Handlers

This property specifies whether the onkeydown, onkeypress and onkeyup event handlers, if any, are executed when entering text.

Enable Focus Event Handlers

This property specifies whether the onfocus, onfocusin, onfocusout, onblur, onactivate, onbeforeactivate and ondeactivate event handlers, if any, are executed when a tag or document gains or loses focus.

Enable Capture Event Handlers

This property specifies whether the onlosecapture event handlers, if any, are executed when a tag or document loses mouse capture.

Enable State Change Event Handlers

This property specifies whether the onreadystatechange event handlers, if any, are executed when the state of a tag or ActiveX object changes.

Enable Error Event Handlers

This property specifies whether the onerror event handlers, if any, are executed when an error occurs.

Logging Tab

This tab contains properties used to determine the level of logging of the JavaScript execution performed during execution of the robot. The logging information can then be obtained in the Log window in Design Studio and may be used to understand which JavaScripts are executed, which errors occur, and so on.

Log All JavaScript Source

This property specifies whether the source of all JavaScripts executed are logged. Note that the JavaScript may declare functions that themselves are not executed until they e.g. are called from an event handler. You may use the JavaScript Changes property to make changes and corrections in the JavaScript.

Log JavaScript Execution Trace

This property specifies whether to log a detailed trace of the JavaScript execution. This trace includes all functions that are called and all properties that are set or retrieved.

For example, when

```
location.href =  
"http://www.kapowtech.com"
```

is executed, the trace will read

```
GET location = [location]
```

followed by a

```
SET [location].href = "http://www.kapowtech.com"
```

Include Function Source in Trace

This property specifies whether to include the source code of the functions executed, in the trace of the JavaScript execution.

Log JavaScript Event Handlers

This property specifies whether to log executed JavaScript event handlers.

Log Timer Events

This property specifies whether to log executed timer events. Timer events are events that occur after a specified amount of time and can be set up either by JavaScript using `setTimeout()` or `setInterval()` or when a `<meta>` redirection specifies that the page should be redirected after a number of seconds.

Log Loads

This property specifies whether to log all page and resource loads.

Log XML HTTP Requests

This property specifies whether to log XML HTTP Requests sent.

Log Absolute Positioning

This property specifies whether to log the absolute positioning of visual components such as menus that are positioned using JavaScript.

Max. Log Entries

This property specifies the maximum number of log entries allowed. The minimum value is "1". If there are more log entries than allowed, the first log entries will be discarded and will thus not appear in the Log window.

Legacy Tab

This tab contains properties that should not be changed in most cases. The legacy properties have been introduced to ensure backward compatibility with older version of the product. If a new feature is introduced in the product that conflicts with the way things were done previously, an option is introduced

on this tab to ensure old robots will work and be backward compatible. On this tab, the default setting represents the current way and the other setting is the old way.

Format Handling

This option specifies how to handle different document formats.

Download non-HTML (Default)

Kapow loads all supported non-HTML content to work with. You can preview CSV, JSON, text, Excel, XML, and binary content and apply step actions to them. Use the Preview button to change the type of the content.

Classic loading

You can specify how to handle different document formats for classic browser engine.

JSON

This property specifies how to handle JSON, which is one of the common response types when calling web services. The default is to convert the JSON to XML which makes it easy to handle in a standard way in Design Studio. Alternatively, it can be converted to HTML. The HTML is more humanly readable than XML, but somewhat harder to extract from automatically.

Convert XML to HTML

This property specifies whether to convert XML documents to HTML documents or keep them as-is. It is mainly used in old robots that work on the converted documents, as this was previously the only option. In newer robots, it is normally more convenient to work directly on the XML structure.

Note To view XML content with the applied XSLT transformation in the windows view, select **Configure Robot > Default Options: Configure > Legacy tab > Format Handling: Classic loading** and clear the **Convert XML to HTML** option.

Convert Excel to HTML

This property specifies whether to convert Excel documents to HTML documents or keep them as-is. It is mainly used in old robots that work on the converted documents, as this was previously the only option. In newer robots, it is normally more convenient to work directly on the Excel document, as this provides a faster and more spreadsheet-like display and user interface.

CSV

This property specifies whether to convert CSV documents to HTML documents or keep them as text (in a PRE-tag). It is mainly used in old robots that work on the text representation, as this was previously the only option. In newer robots, it is normally more convenient to work on a HTML table representation of the CSV document and use the full power of Design Studio when doing so. It is assumed that the CSV documents is encoded using commas (,) as separator character, double quotes (") as quoting character and backslash (\) as escape character. If the document you are loading does not conform to this convention you should use the Convert to Text option and work on the document as text, e.g. using the Extract CSV step action.

Plugin Simulation from JSON Variable

You can construct your own plugins using a JSON variable. This is an example of how the JSON structure can look like:

```
[
  {
    "name" : "Shockwave Flash",
    "description" : "Shockwave Flash 18.0 r0",
    "filename" : "NPSWF32_18_0_0_232.dll",
    "mimeTypes" : [
      {
        "type" : "application/x-shockwave-flash",
        "description" : "Adobe Flash movie",
        "suffixes" : "swf"
      },
      {
        "type" : "application/futuresplash",
        "description" : "FutureSplash movie",
        "suffixes" : "spl"
      }
    ]
  },
  {
    "name" : "Silverlight Plug-In",
    "description" : "Silverlight Plug-In 5.1.40416.0",
    "filename" : "npctrl.dll",
    "mimeTypes" : [
      {
        "type" : "application/x-silverlight",
        "description" : "npctrl",
        "suffixes" : "scr"
      },
      {
        "type" : "application/x-silverlight-2",
        "description" : "",
        "suffixes" : ""
      }
    ]
  }
]
```

You can use the following code to generate a JSON variable to be used in the plugin simulation. Just save the code to an HTML file and open it in a browser. The generated text can then be copied directly to a JSON variable on the [Plugins](#) tab of the [Options](#) window in Design Studio.

```
<!doctype html>
<html>
<body>
<div id="plugins"></div>
</body>
<script>
var plugins=[];
for(var n=0; n<navigator.plugins.length; n++) {
  plugins.push({});
  plugins[n].name=navigator.plugins[n].name;
  plugins[n].description=navigator.plugins[n].description;
  plugins[n].filename=navigator.plugins[n].filename;
  plugins[n].mimeTypes=[];
  for(var m=0; m<navigator.plugins[n].length; m++) {
    plugins[n].mimeTypes.push({});
    plugins[n].mimeTypes[m].type=navigator.plugins[n][m].type;
    plugins[n].mimeTypes[m].description=navigator.plugins[n][m].description;
    plugins[n].mimeTypes[m].suffixes=navigator.plugins[n][m].suffixes;
  }
}
var json = document.getElementById("plugins");
```

```
json.innerHTML= JSON.stringify(plugins);  
</script>  
</html>
```

Step Configuration

A step can be configured using a number of properties. These are listed below.

Basic Tab

This tab contains various basic step properties.

Step Name

Here, you can enter the name of the step.

Step Comment

Here, you enter an optional comment about this step.

Finders Tab

This tab contains the tag or range finders used by the step to find the tags/ranges that the action of the step should use. For more information, see the description of the [Tag or Range Finders](#).

Action Tab

In this tab, you can select and configure the action of the step.

Error Handling Tab

This tab contains properties that control how to [handle errors](#) that occur during execution of this step.

Windows

A *window* holds HTML, XML or other content in a robot. One or more windows are always open, and one window is the *current window*, i.e. the window containing the page that a step-action works on. In Design Studio, each window is displayed in a tab, and the current window is marked with a yellow arrow.

Windows allow you to handle multiple pages simultaneously. Note, however, that a step can only work on a single page at a time, so you need to change the current window whenever you want to work on another page than the current one.

Using the appropriate step actions, you can:

- Open a new window using the [New Window](#) action
- Set the current window using the [Set Current Window](#) action
- Close a window using the [Close Window](#) action

In Design Studio, an easy way to insert a Set Current Window step is to right-click on the window's tab and choose Set as Current Window.

When loading a page that loads other pages (e.g. a page containing a `<frameset>`-tag), each page will automatically be loaded into a separate window.

Each window can have one or more [named tags or ranges](#). Note that each named tag or range belongs to a specific window.

Identifying a Window

Some step actions (for example the ones mentioned above) are configured to operate on a particular window. The window may be identified in three ways:

- by its name as displayed in the window's tab or by the number of the window's tab
- by the found tag
- by a [pattern](#) matching against the windows name.

The name is the more stable of the two alternatives in face of robot changes, and also (most subtly) when a step may be reached via different paths that open different windows. Thus the name is the preferred way to identify a window. Matching does not work on windows showing variables, because the names of these are fixed.

In some cases, however, the name is not the same every time the robot is run. For example, some Web sites are based on frames but name these frames differently each time (while keeping the structure of the frame set). Because the window name is derived from the frame's name, the window name is not much use in such a case, and the windows must be referenced by their numbers. In these situations, it is important to make sure that every path through the robot that can lead to the step action in question results in the same window structure and window numbers.

You can also use tags to identify a window. The found tag must be a FRAME, IFRAME, OBJECT or EMBED element. In Design Studio, the list of frames is displayed as a tree in the [Frames View](#). Use the **Window in Found Tag** option in the [Set Current Window](#) action to set the current window by the found tag.

There are two alternative ways of identifying a window:

- Specifying a pattern for the window name
- Specifying a pattern for the (text or HTML) content of the window

In both cases, the pattern must be precise enough that only the name of a single window matches it.

Named Tags, Ranges, and JSON

Named tags, ranges, and JSON are markers that can be used for finding other tags, ranges, and some JSON text respectively. Steps use Finders to find the elements they work on (either HTML/XML tags, Excel ranges, or named JSON depending on the kind of content the step works with). A finder may be based on what has been found by previous steps by referring to named tags, ranges, or JSON.

All named tags/ranges/JSON belong to a [window](#). Each window can have any number of named tags/ranges, but only of the appropriate type: Named tags for windows with HTML/XML content, named ranges for windows with spreadsheet content, and named JSON for windows with JSON.

Named tags/ranges are set by many steps. For example, loop steps typically use a named tag/range as a marker for the current iteration of the loop. You can also use the [Set Named Tag](#), [Set Named JSON](#), or [Set Named Range](#) actions to explicitly name a tag, range, or JSON. This can be useful when you want to simplify the finders in subsequent steps.

In Design Studio, the named tags or ranges in a window are shown using blue boxes. When you right-click in the current window to perform an action on a tag or range, the [Tag or Range Finders](#) of the new step will automatically be configured to search using the named tags or ranges of the window whenever possible.

Tag, Range, and JSON Finders

A Finder is used to find a tag on an HTML/XML page, a range of cells in a spreadsheet document, or an element in a JSON structure. Finders are used in steps, where they identify what part of the page the step should work on. The list of Finders of the current step is located in the "Finders" tab in the Step View.

Finders look very different depending on the kind of page they work on, and the finders for each kind are described separately. See [Tag Finders](#) for details on the kind of finders used with HTML/XML pages, [Range Finders](#) for details on the kind of finders used with spreadsheet content, and [JSON Finders](#) for details on JSON Finders.

Tag Finders

A Tag Finder is used to find a tag on an HTML/XML page. Tag Finders are used in steps, where they define how to find the tag(s) to which the step should be applied. The list of Tag Finders of the current step is located in the "Finders" tab in the Step View. Steps that work on spreadsheet content use [Range Finders](#) rather than Tag Finders.

Understanding Tag Paths

In understanding how to use Tag Finders, the concept of a *tag path* is important. A tag path is a compact text representation of where some tag is located on a page. Consider this tag path:

This tag path refers to an `<a>`-tag inside a `<div>`-tag inside a `<body>`-tag inside an `<html>`-tag.

html.body.div.a

A tag path can match more than one tag on the same page. For example, the above tag path will match all of the `<a>`-tags on this page, except the third one:

```
<html>
  <body>
    <div>
      <a href="url...">Link 1</a>
      <a href="url...">Link 2</a>
    </div>
    <p>
      <a href="url...">Link 3</a>
    </p>
    <div>
      <a href="url...">Link 4</a>
      <a href="url...">Link 5</a>
      <a href="url...">Link 6</a>
    </div>
  </body>
</html>
```

You can use indexes to refer to specific tags among tags of the same type at that level. Consider this tag path:

html.body.div[1].a[0]

This tag path refers to the first <a>-tag in the second <div>-tag in a <body>-tag inside an <html>-tag. So, on the page above, this tag path would only match the "Link 4" <a>-tag. Note that indexes start from 0. If no index is specified for a given tag on a tag path, the path matches any tag of that type at that level, as we saw in the first tag path above. If the index is negative, the matching tags are counted backwards, i.e. starting with the last matching tag which corresponds to index -1. Consider this tag path:

```
html.body.div[-1].a[-2]
```

This tag path refers to the second-to-last <a>-tag in the last <div>-tag in a <body>-tag inside an <html>-tag. So, on the page above, this tag path would only match the "Link 5" <a>-tag.

You can use an asterisk (*) to mean any number of tags of any type. For example, the tag path

```
html.*.p|div|td.a
```

This tag path refers to an <a> tag inside a <p>- , <div>- , or <td>-tag located anywhere inside an <html> tag.

In a tag path, text on a page is referred to just as any other tag, using the keyword "text". Although text is not technically a tag, it is treated and viewed as such in a tag path. For example, consider this HTML:

```
<html>
  <body>
    <a href="url...">Link 1</a>
    <a href="url...">Link 2</a>
  </body>
</html>
```

The tag path "html.body.a[1].text" would refer to the text "Link 2".

Tag Finder Properties

A Tag Finder can be configured using the following properties.

Find Where

In this property, you can specify where to find the tag relative to a [named tag](#). The default value is "Anywhere in Page", meaning that named tags are not used to find the tag.

Tag Path

In this property, you can specify the tag path as described in the previous section. The tag path can be specified in several ways using a [Value Selector](#).

Attribute Name

In this property, you can specify that the tag must have a specific attribute, for example "align".

Attribute Value

In this property, you can specify that the tag must have an attribute with a specific value. If the Attribute Name property is set, the attribute value is bound to that specific attribute name.

- "Equals Text" specifies that the attribute value must match a specified text. Note that the text must match the entire attribute value.
- "Containing Text" specifies that the attribute value must contain the specified text.

- "Pattern" specifies that the attribute value must match a pattern. Note that the pattern must match the entire attribute value.

Tag Pattern

In this property, you can specify a [pattern](#) that the tag must match (including all tags inside it), for example `".*Stock Quotes.*"`. Some caution should be observed in using this property, since it can have considerable impact on the performance of you robot. This is because the "Tag Pattern" may be applied many times throughout a page just to find the one tag that it matches. One way to try and avoid this is to choose "Text Only" for the "Match Against" property.

Match Against

In this property, you can specify that the "Tag Pattern" should match only the text or the entire HTML of the tag. The default is to match only the text because this is normally much faster.

Tag Depth

This property determines which tag to use if matching tags are contained inside each other. The default value is "Any Depth" which accepts all matching tags. If you select "Outermost Tag", only the outermost tags are accepted, and similarly, if you select "Innermost Tag", only the innermost tags are accepted.

Tag Number

This property determines which tag to use if more than one tag matches the tag path and the other criteria. You specify the number of the tag to use, either counting forwards from the first tag or counting backwards from the last tag that matches.

Example

As an example, if you set the Tag Path property to "table", the Attribute Name property to "align", the Attribute Value property to Fixed Text where the text must be "center", and the Tag Pattern property to `".*Business News.*"`, then the Tag Finder would locate the first <table>-tag that is center aligned and that contains the text "Business News".

Range Finders

A Range Finder is used to find a cell or a range of cells in a spreadsheet. Range Finders are used in steps, where they define how to find the cell(s) to which the step should be applied. The list of Range Finders of the current step is located in the "Finders" tab in the Step View. Steps that work on HTML or XML pages use [Tag Finders](#) rather than Range Finders.

You can select between different starting points when you configure a range finder:

Find Specified Range

Specify (in Range) a cell or range of cells using almost ordinary Excel syntax. Keep in mind that (in contrast to Excel) the sheet name must be given.

The range can be specified in several ways using a [Value Selector](#).

Find at Named Range

Specify in (Range) a previously defined [named range](#) as the starting point. It may have been defined by for example a [Set Named Range](#) step or a [Loop in Excel](#) step.

Once a range has been selected as the starting point it may be adjusted in several ways as specified by the Use property, which can make it both smaller or larger. See below for details.

Finally, the Use Upper Left Cell in Merged Cells property determines how to handle merged cells in the spreadsheet. Remember that in Excel, adjacent cells can be "merged" visually to form a larger cell with a single value. Excel considers the larger "merged cell" to have the same cell address as the uppermost and leftmost sub-cell, and the value of the "merged cell" is found at this cell address (only). This is mimicked accurately by Kapow but it is not always convenient when doing automated extraction, especially as part of an iteration. Thus if you enable Use Upper Left Cell in Merged Cells and the range refers to a single sub-cell within a "merged cell", then it is modified to refer to the uppermost and leftmost sub-cell of the "merged cell" to make it easier to get at the contents.

Cell Ranges

When configuring a [Range Finder](#) to Find Specified Range you write a piece of text that refers to a cell (or a range of cells). Such references are also displayed (and can be entered) in the Cell Range View at the bottom of the Spreadsheet View. The basic form is known from Excel formulas, but Kapow provides some extensions.

The following examples show the variants:

Sheet1!B3

The core elements and how they are put together: The sheet name ("Sheet1"), a separating exclamation mark, a column name ("B") and a row number ("3"). This example refers to a single cell of the named sheet.

B3

When the cell range reference is entered in the Cell Range View at the bottom of the Spreadsheet View, the sheet name can be omitted if you want to refer to the currently displayed sheet. It will, however, be added to the reference as soon as you press Enter. In a Range Finder you need to enter the sheet name every time, as there is no notion of "currently displayed sheet" during execution of the robot. For this reason the remaining examples will all include the sheet name.

Sheet3!B3:F14

How to refer to a range of cells from a single sheet: After the sheet name, you state the upper left and lower right corners, separated by a colon. (It is not possible to have a range that extends over several sheets.)

Sales!C

All of column "C" of the stated sheet. Open ended ranges like this one are not permitted in Excel, but are very useful in robots that must be able to adapt to different sizes of Excel documents. When the robot works on a specific document, it will automatically limit itself to the area of the document that actually contains data. Open ended ranges will often be used in the Range Finder of a [Loop in Excel](#) step.

Sales!C:H

All of the columns C to H of the stated sheet and is an open ended range as explained above.

Suppliers!14

Open ended ranges can also be rows. This example refers to all of row 14 of the stated sheet.

Suppliers!14:29

A fixed range that refers to all of rows 14 up to and including 29 of the stated sheet.

'Total Sales'!B3

If the sheet name contains white space or certain special characters, it must be enclosed in single quotes. If the sheet name contains a single quote, it must be entered as two single quote characters. The rules are just the same as when sheet names are included in cell references in Excel formulas.

!B3

The Excel "document properties" (for example, the name of the author and the creation date of the document) are made available in Kapow in the form of a special sheet whose name is empty. Thus this example refers to the value of one of the document properties (the name of the property will be available in the neighboring cell "!A3"). This is an extension over Excel.

JSON Finders

A JSON Finder is used to find necessary data in a JSON text. The list of Finders of the current step is located in the Step View, Finders tab.

For more information about JSON and its terminology see [Working with JSON](#).

JSON Finder Properties

A JSON Finder can be configured using the following properties.

Find Where

In this property, you can specify where to find a JSON element. The default value is "Anywhere in JSON", meaning that named JSONs are not used in a search.

In this named JSON

This property is used when you select **In Named JSON** in the **Find Where** list. In this property, you can specify whether to search in the selected Named JSON or you can specify a name of the Named JSON to use.

Path

In this property, you can specify the path to the JSON element. The tag path can be specified in several ways using a [Value Selector](#).

JSON path expressions always refer to a JSON structure in the same way as XPath expression are used in combination with an XML document. JSON path expressions are very similar to the JavaScript and use the dot-notation, for example `personnel.person[0].name.@top:` element is required and tells the finder to search from the top of the JSON.

Examples

JSON Path

The following is a simple JSON structure and a table with path examples and possible results.

```
{
  "personnel" : {
    "person" : [
      {
        "ID" : 0,
        "name" : "Bob",
        "age" : 26,
        "isMale" : true
      },
      {
        "ID" : 1,
        "name" : "Ted",
```

```

    "age" : 25,
    "isMale" : true
  },
  {
    "ID" : 2,
    "name" : "Jill",
    "age" : 47,
    "exam" : "553213-3",
    "isMale" : true
  },
  {
    "ID" : 3,
    "name" : "Rick",
    "age" : 50,
    "exam" : "553225-3",
    "isMale" : true
  }
]
}

```

XPath	JSON Path	Result
/personnel/person[2]/name	@top:.personnel.person[1].name	Ted
/personnel	@top:.personnel	Extracts all information from "personnel"

If you want to extract a set of information from a JSON element, you can create an XML page from JSON and extract necessary information using a text expression. For example, if you create an XML page from the JSON above, select `item[1]` in the XML, and run an expression like `". * <name>"+TheInput+"</name>.*"`, as a result you should get something similar to `1Ted25true`.

Finding a Named JSON

In the following example Named JSON is a part of a JSON text that can be used in a JSON Finder to find "a":

In the following JSON text:

```
{ "a" : [ { "b" : [1,2,3] } ], "c" :42 }
```

we can have the Named JSON mark

```
"b" : [1,2,3]
```

and thus we can have a JSON Finder perform a search with the following properties:

Find Where: In Named JSON

In this Named JSON: 1

Path: [1]

This finder will then find the number 2 in the list.

Patterns

A pattern is a way of describing a text. For example, the text "32" can be described as a text containing two digits. However, other texts also contain two digits, e.g. "12" and "00". We say that these texts match the pattern. (Design Studio patterns follow the Perl5 syntax.)

A pattern is composed of normal characters and special symbols. Each special symbol carries its own special meaning. For example, the special symbol "." (dot) means any single character and matches all single characters, e.g. "a", "b", "1", "2", ...

Special Symbols

You can use the following special symbols within a pattern.

Special Symbol	Description
.	any single character, e.g. "a", "1", "/", "?", "." etc.
\d	Any decimal digit, e.g. "0", "1", ..., "9".
\D	Any non-digit, e.g. same as "." excluding "0", "1", ..., "9".
\s	Any whitespace character, e.g. " ", tab, and return
\S	Any non-whitespace character, e.g. same as "." excluding " ", tab, and return
\w	Any word (alphanumeric) character, e.g. "a", ..., "z", "A", ..., "Z", "0", ..., "9".
\W	Any non-word (alphanumeric) character, e.g. same as "." excluding "a", ..., "z", "A", ..., "Z", "0", ..., "9".
\n	A line break character.
\r	A carriage return character.
\t	A tab character.
[abc]	Any character in the set a, b or c.
[^abc]	Any character not in the set a, b or c.
[a-z]	Any character in the range a to z, inclusive.
a b	Matches whatever the subpattern a would match, or whatever the subpattern b would match.

If you want a special character, such as "." or "\", to act as a normal character, you can escape it by adding a "\" (backslash) in front of it. So, if you wish to match exactly the "." character, instead of any single character, you should write "\.".

You can organize a pattern into subpatterns by the use of parentheses: "(" and ")". The pattern "abc" can be organized as "(a)(bc)". Subpatterns are useful when applying pattern operators.

Example: Simple Example Patterns

Here are some examples of patterns and what they match:

Pattern	Matches
.an	All texts of length three ending with "an", e.g. "can" and "man" but not "mcan".
\d\d\s\d\d	All texts of length five starting with two digits followed by a whitespace and ending with two digits, e.g. "01 23" and "72 13" but not "01 2s"
m\n\o	The text "m.n\o"
(good) (bye)	"good" and "bye" but not "goodbye"

Repeating Operators

These operator symbols will repeat the previous character, symbol, or subpattern.

Special Symbol	Description
{m}	Matches exactly m repetitions of the preceding subpattern.
{m,n}	Matches between m and n repetitions (inclusive) of the preceding subpattern. It will match as many subpatterns as possible.
{m,n}?	Matches between m and n repetitions (inclusive) of the preceding subpattern. It will match as few subpatterns as possible
{m,}	Matches m or more repetitions of the preceding subpattern. It will match as many subpatterns as possible.
{m,}?	Matches m or more repetitions of the preceding subpattern. It will match as few subpatterns as possible.
?	The preceding subpattern, or the empty text. Shorthand for {0,1}
*	Matches any number of repetitions of the preceding subpattern, or the empty text. Shorthand for {0,}. It will match as many subpatterns as possible.
*?	Matches any number of repetitions of the preceding subpattern, or the empty text. Shorthand for {0,}?. It will match as few subpatterns as possible.
+	Matches one or more repetitions of the preceding subpattern. Shorthand for {1,}. It will match as many subpatterns as possible.
+?	Matches one or more repetitions of the preceding subpattern. Shorthand for {1,}?. It will match as few subpatterns as possible.

These operators repeat the previous character, symbol, or subpattern.

Example: Examples Using Repeating Operators

Here are some examples of patterns that use repeating operators, and what they match.

Pattern	Matches
.	Any text, e.g. "hello", "1213" and "" (the empty text)
(abc)*	Matches any number of repetitions of the text "abc", e.g. "", "abc", "abcabc", and "abcabcabc", but not "abca"
(.)(.)*	Will match "abc" - the first subpattern will match "abc" and the second subpattern will match "" (the empty text)
(.*?)(.)*	Will match "abc" - the first subpattern will match "" (the empty text) and the second subpattern will match "abc"
(.+?)(.)*	Will match "abc" - the first subpattern will match "a" and the second subpattern will match "bc"
\w*d	Will match "abc1abc1" - \w* matches "abc1abc" and \d matches "1"
\w*?d	Will match "abc1" but not "abc1abc1" - because the "\w*?" will only match "abc" and the rest cannot be matched by \d
(\d\d){1,2}	Matches either two or four digits, e.g. "12" and "67", but not "123".
(good)?bye	"goodbye" and "bye".

More About Grouping

We have seen that "(" and ")" can be used for grouping subpatterns into a new subpattern. But this actually serves another purpose: you can use these groups in expressions. To make a grouping that cannot be used in expressions you can use "(?:".

You can refer to other groups in your pattern using `\n`, where *n* is the group number.

Example: Grouping Examples

Here are some examples of patterns that use grouping, and what they match

Pattern	Matches
a(bc)	Matches "abc", and you can refer to "bc" as \$1 in your expressions. Matches "abc", but you can not refer to "bc" in your expressions. Matches "abc=abc", but does not match "abc=ab"
a(?:bc)	
(.*)=1	

Expressions

An *expression* typically evaluates to a text. For example, the expression "The author of the book " + Book.title + " is " + Book.author + "." evaluates to the text "The author of the book Gone with the Wind is Margaret Mitchell.", if the attributes title and author of the Book variable contain the texts "Gone with the Wind" and "Margaret Mitchell", respectively.

You can do also numeric calculations within the expression. For example, if the attribute Book.price contains the price of a book, you can multiply it by 100 using the following expression:

```
Book.price * 100
```

Depending on where the expression occurs, an input text may be available for use in the expression. You can refer to this input text in the expression using the INPUT notation. For example, if the input text is "The time is " and you want to add the current time, you can use this expression:

```
INPUT + time(now())
```

Expression Types

Expression Type	Notation	Description	Examples
Constant	"text"	A fixed text. You can use the backslash character (\) to enter special characters: \n for line break \r for carriage return \f for form document \t for horizontal tab \b for backspace \" for double quote ' for single quote \\ for backslash itself \uxxxx for the unicode character with encoding xxxx, where xxxx is four hexadecimal digits.	"This is some \"quoted\" text." "This a text with line break\n, tab \t and a unicode \u0035 character"
Constant	>>text<<	A fixed text. This notation can contain anything, including quote characters, except the end symbol (<<). The backslash (\) character cannot be used to enter special characters.	>>This is some "quoted" text.<<
Variables	variable.attribute variable	The value of a variable. If the variable is a complex type, an attribute name must also be supplied.	Book.title Integer
Input Text	INPUT	The input text, if any, to the expression.	INPUT
Concatenation	expr1 + expr2	The concatenation of the two expressions expr1 and expr2.	"Title:" + Book.title
Subpattern Match	\$n	If n > 0, the text that matches subpattern n in the pattern. If n = 0, the text that matches the entire pattern. Note: This expression has meaning only if there is a pattern associated with the expression.	\$1
Numeric Expression	Operators: +, -, *, /, %	The result of a numeric expression.	Book.price * 100
Boolean Expression	Operators: && (and), (or)	The result of a boolean expression.	performTransactions && Book.price < 30
Conditional Expression	condition ? expr1 : expr2	If condition evaluates to true, the value of expr1 is used; otherwise the value of expr2 is used.	Book.price < 30 ? "cheap" : "expensive"
Function	func(expr)	The function func applied to the result of the expression expr. See the Functions section that follows this table for the available functions.	capitalize(Book.title)
Current URL	URL	The current URL.	URL

Expression Type	Notation	Description	Examples
Current Window	WINDOW	The unique ID of the current window.	WINDOW
Robot Name	Robot.name	The name of the robot.	Robot.name
Execution ID	Robot.executionId	The current execution ID of the robot.	Robot.executionId
Execution Errors	Robot.executionErrors	The execution errors encountered in the previous branch of the nearest Try step.	Robot.executionErrors

Note The >>text<< notation for a text constant is useful to specify a long text that contains many quote characters, such as HTML. Using the >>text<< notation, you can use the text as is, and simply place the >> and << symbols around it. If you use the "text" notation, you have to replace all quote characters in the text with two consecutive quote characters.

Functions

Function	Description
abs(arg)	Returns the absolute value of the number.
base64Decode(arg)	Decodes Base64 encoded data.
base64Encode(arg)	Encodes binary data with Base64 encoding.
binaryToText(data[, encoding])	Decodes binary data into text. Uses the specified encoding if present, or otherwise defaults to UTF-8 encoding.
capitalize(arg)	Makes the first letter of every word upper case and all other letters lower case.
ceil(arg)	Rounds the number up to the nearest integer.
collapseSpaces(arg)	Makes sure there are no two consecutive spaces.
contains(source, key)	Returns whether the source contains the specified key.
date()	Returns the current date in standard date format (yyyy-mm-dd).
day(args)	Returns the day of month of the date given as an argument.
endsWith(source, key)	Returns true if the source string ends with the specified key, or false otherwise.
excelColStringToNumberFunction	Converts a string from an Excel spreadsheet to a number.
excelNumberToColStringFunction	Converts a number to a string in an Excel spreadsheet.
floor(arg)	Rounds the number down to the nearest integer.
guid()	Returns a randomly generated, globally unique ID (GUID).
hexDecode(arg)	Decodes hex encoded data.
hexEncode(arg)	Encodes binary data with hex encoding.
indexOf(source, key)	Returns the first index of the key in the source, or -1 if not found.
length(arg)	Counts the number of characters in the text, or the number of bytes if given binary data.
max(a, b)	Returns the greater of the two numbers.
md5(arg)	Computes the MD5 checksum of the binary data given as an argument.
min(a, b)	Returns the smallest of the two numbers.
month(args)	Returns the month of the date given as argument.

Function	Description
now()	Returns the current date and time.
random()	Returns a random number between 0 and 1.
removeSpaces(args)	Removes all white space characters in the argument, such as SPACE, \t, \n.
replacePattern(source, pattern, newText)	Replaces every occurrence of the pattern "pattern" in text "source" with the text "newText". The pattern match is case insensitive.
replaceText(source, oldText, newText)	Replaces every occurrence of the text "oldText" in the text "source" with the text "newText". The match with "oldText" is case insensitive.
resolveURL(arg)	Converts a URL from relative to absolute using the current URL.
round(arg)	Rounds to the nearest integer.
shortTime(arg)	Returns the time without fractional seconds (hh:mm:ss) for the date given as an argument.
substring(source, startIndex, endIndex)	Returns the portion of the source string starting at the startIndex and up to the endIndex, not including the character at endIndex. If no endIndex is specified, the function behaves as if the length of the source string was given as endIndex.
startsWith(source, key)	Returns true if the source string starts with the specified key, or false otherwise.
textToBinary(text[, encoding])	Encodes text to binary data. Uses the specified encoding if present, or otherwise defaults to UTF-8 encoding.
time(arg)	Returns the time (hh:mm:ss.fff) for the date given as an argument.
toInteger(args)	Converts the text to an integer. This can be useful if you want to include it in calculations.
toNumber(args)	Converts the text to a floating-point number. This can be useful if you want to include it in calculations.
toLowerCase(arg)	Converts all of the characters in the text to lowercase.
toUpperCase(arg)	Converts all of the characters in the text to uppercase.
trim(arg)	Removes all space from both ends of the text.
urlDecode(arg)	Decodes the URL encoded text.
urlEncode(arg)	URL encodes the text.
weekday(arg)	Returns the name of the weekday (in English) for the date given as an argument.
year(args)	Returns the year of the date given as an argument.

Error Handling

When an error is encountered during execution of a step, it is handled as specified on the Error Handling tab for the step's configuration. Test actions may also apply the same handling when a condition fails. There are two aspects of handling an error or failed test: How and where to report or log the incident, and how and where to proceed with execution of the robot.

Properties

Error Handling is configured using the following properties.

API Exception

This property specifies whether to report the incident back to the caller of the robot. Reporting works differently depending on how the robot is executed:

- The property has no effect when the robot is executed in Design Mode in Design Studio because the incident always is reported in this mode (except when it is handled using Ignore and Continue as described below).
- When the robot is executed in Debug Mode, the report is added to the Error Reports tab.
- When the robot is run in the Management Console, reports are just counted (and displayed as the number of errors encountered in the "previous" run of the schedule). In this scenario, we recommend using the same value (checked or unchecked) as for Log as Error.
- When the robot is executed by a client via one of the APIs and runs in RoboServer, the report is sent back to the caller via the API as follows:

```
RobotErrorResponse
```

This causes an exception at the caller side, at least when using the default RQLHandler. (This case explains the name of the property.)

Note The property may be unchecked or checked, but may also be marked with an asterisk * meaning that it has been explicitly set to a non-default value. This is explained in Show Changes from Default, where it is also shown how to remove the asterisk and revert to the default value. When the default value applies (that is, when no asterisk is present), be aware that the default varies according to the selection made under the Then property.

Log as Error

This property specifies whether to log the incident. This differs from reporting (see the preceding).

- When the robot is executed in Design Mode in Design Studio, the incident is added to the log that is displayed when you select View Log in the View menu.
- When the robot is executed in Debug Mode, the incident is added to the Log tab.
- When the robot is run in RoboServer (from the Management Console or via the API), the incident is logged in the place defined in the cluster settings for the given RoboServer. This is most likely the same database that the Management Console uses.

Note The property may be unchecked or checked, but may also be marked with an asterisk * exactly as explained earlier for API Exception.

Then

This property specifies how and where to continue execution of the robot after the incident. The following options are available.

Skip Following Steps (Default)

The steps following the one with the error (or failed test condition) are not executed. Execution otherwise proceeds as if they had been executed successfully.

Ignore and Continue

The step with the error (or failed test condition) is skipped, and execution continues with the following step as usual.

Try Next Alternative

This can be used in a branch coming out of a Try step. Execution of the current branch from the Try step is abandoned and execution continues with the first step on the next branch from that Try step. Execution will continue there with the same robot state as for the first branch.

If the current branch is the last one from that Try step, Try Next Alternative is not illegal, but results in an error ("all alternatives failed") which is handled according to the way error handling is configured for the Try step.

When Try steps are nested, it is possible to select the relevant Try step among those that are on the execution path to the current step.

Send Backwards (legacy)

This option is present only to provide backwards compatibility with robots created by Design Studio versions prior to 8.0. It is described [separately](#).

Next Iteration

This can be used within a loop, that is, following a loop step of some kind (except a Repeat-Next loop). Execution of the current loop iteration is abandoned and execution continues with the next iteration. That is, execution continues with the first step after the loop step, and with a robot state that corresponds to the next looped-over item.

When loops are nested, it is possible to select the relevant loop in which to go to the next iteration.

Break Loop

This can be used within a loop, that is, following a loop step of some kind (including a Repeat-Next loop). Execution of the loop is abandoned. Thus the current iteration is not finished, and subsequent iterations are not executed at all. This means that execution continues with the same step as after normal termination of the loop.

When loops are nested, it is possible to select the relevant loop among those that are on the execution path to the current step.

Step References in At...

Under [error handling](#) you can select various ways to proceed in case an error occurs. The following three ways listed require that you identify a previous step on the execution path (either a Try step or a loop step) where execution should proceed. Execution proceeds at or after the selected step depending on which one you select:

- Try Next Alternative
- Next Iteration
- Break Loop

When identifying the preferred step, you can select the "nearest step" (of the appropriate kind) or a specific step by name. Sometimes, however, the preferred step does not appear in the selection list for a number of reasons:

- Only named steps can be selected. If the step is unnamed (the default for Try steps), the step must be given a name before it will appear in the selection list. If the step is the nearest one of the appropriate kind, you can also reach it by selecting "nearest step."
- Remember that Next Iteration cannot be used with Repeat steps. Thus Repeat steps do not appear in the selection list for Next Iteration.

- A step name never appears more than once in the selection list, because any reference always goes to the nearest step (of the appropriate kind) with the selected name. Keep that in mind when modifying the robot!
- If more than one path through the robot leads to the current step, an (appropriate) step with the selected name must be present on every path to the current step. Otherwise, the name does not appear on the selection list.

The last two rules support using error handling in an advanced way that is very similar to the try-catch constructs in Java or C#. See the [Try-Catch](#) section for more on this. In those programming languages, you "throw" a named "exception" at the point of error, and "catch" it (by name) somewhere in surrounding code. In robots, you can do something similar with Try steps. The correspondence between the Java/C# terms and the Design Studio terms is described in the table.

Java/C# term	What to use in Design Studio
try	The first branch of a Try step
Name of an exception	Name of a Try step
throw E	Handling an error with "Try Next Alternative at E"
catch E	The second branch of a Try step named "E"

This way of thinking about error handling probably is most useful in large robots. When using error handling this way, the names of the Try steps signal what kind of exceptional circumstances each Try step's second branch handles.

Send Backwards (legacy)

Send Backwards (legacy) is one of the options for [error handling](#). It is present only to provide backwards compatibility with robots created by Design Studio versions prior to 8.0 and should not be used in new robots.

Send Backwards is similar to another error handling option, Try Next Alternative, because it affects execution of the branches that go out from a Try step. However, it does so in a quite different way. Its immediate effect is that the steps following the current one are not executed (similar to Skip Following Steps). Aside from that, execution of the current branch from the Try step continues. However, the error is also "sent backwards" to the Try step and remembered there, which causes execution to continue with the next branch of the Try step once execution of the current branch has finished successfully. This part is similar to the effect of Try Next Alternative (although delayed), and the same comments regarding the robot state apply.

If the current branch is the last one from that Try step, Send Backwards is not illegal, but results in an error ("all alternatives failed") which is handled according to the way error handling is configured for the Try step.

If there is no prior Try step to be found, the error is "sent backwards" to the beginning of the robot and is reported via the API and logged just before execution of the robot finishes.

Send Backwards is quite difficult to work with because of the delayed effect, and we recommend Try Next Alternative instead. When robots created using Design Studio versions prior to 8.0 are opened, they are automatically modified to use Try Next Alternative instead of Send Backwards (whenever this can be done without changing the results from the robot).

POST Requests as URLs

A standard URL can represent only a GET request, but not an HTTP POST request. To represent a POST request as a URL, Kapow uses its own special URL format with the following syntax:

`post://<url excluding the http protocol>??<encoded POST parameters>`

or, for the https protocol:

`posts://<url excluding the https protocol>??<encoded POST parameters>`

or, for a relative URL without a protocol:

`postx://<url without protocol>??<encoded POST parameters>`

Example

A POST request to the URL

`http://www.abc.com`

with the encoded POST parameters

`x=y&v=z`

is represented as the following URL:

`post://www.abc.com??x=y&v=z`

The Library Protocol

You can use the Kapow non-standard *library* protocol to refer to a file that a robot belongs to in the robot library.

For example, if the file `MyPage.html` is located in the folder `MyFolder` in the robot library folder, you can refer to it using this URL:

`library:/MyFolder/MyPage.html`

This works whether the robot library is represented as a folder or is packed into a robot library file.

Value Selector

Use the Value Selector to specify a value in different ways, depending on your need.

Use the drop-down menu on the right side of the Value Selector to select one of the following ways to specify the value (not all of these ways are available everywhere):

Value

Enter or select a fixed value.

Variable

Select the value of a variable.

Expression

Enter an [expression](#).

Converters

Select a list of [data converters](#), whose output is used as the value. (The input text to the data converters is empty.)

URL Selector

Use the URL Selector to specify a URL in different ways, depending on your needs.

Use the drop-down menu at the top of the URL Selector to select one of the following ways to specify the URL.

URL

Enter the URL directly in the text field provided. Note that standard URLs using the HTTP protocol can be shortened. For example, you can enter `www.kapowtech.com` instead of `http://www.kapowtech.com`.

URL in Found Tag

Specifies that the found tag contains the URL. The found tag must be one of the following types:

- ``
- `<area href="URL">`
- `<frame src="URL">`
- `<iframe src="URL">`
- `<script src="URL">`
- `<param value="URL">`
- `<meta http-equiv="Refresh" content="...; url=URL">`

URL in Variable

Specifies that the URL should be read from a specified variable.

URL from Expression

Specifies an [expression](#) as the URL to open.

URL from Converters

Specifies a list of [data converters](#) whose output is used as the URL to open.

Keyboard Help

Single-Line Text Fields

Description	Keyboard Shortcut
Move to prev/next word	Ctrl+Left, Ctrl+Right
Move to start/end of field	Home/End
Select all	Ctrl+A
Deselect all	arrow keys

Description	Keyboard Shortcut
Extend selection left/right	Shift+Left, Shift+Right
Extend selection to start/end	Shift+Home, Shift+End
Extend selection to prev/next word	Ctrl+Shift+Left, Ctrl+Shift+Right
Copy selection	Ctrl+C
Cut selection	Ctrl+X
Paste from clipboard	Ctrl+V
Delete next character	Delete
Delete previous character	Backspace

Multi-Line Text Fields

Description	Keyboard Shortcut
Move to start/end of line	Home, End
Move to prev/next word	Ctrl+Left/Right
Move to start/end of text	Ctrl+Home/End
Block move up/down	PgUp, PgDn
Block move left	Ctrl+PgUp
Block move right	Ctrl+PgDn
Select all	Ctrl+A
Copy selection	Ctrl+C
Cut selection	Ctrl+X
Paste Selected Text	Ctrl+V
Delete next character	Delete
Delete previous character	Backspace
Insert line break	Enter

Buttons

Description	Keyboard Shortcut
Activate	Spacebar

Drop-Down Menus

Description	Keyboard Shortcut
Toggle menu up or down	Alt+Up/Down

Multi-Line Text Fields

Description	Keyboard Shortcut
Expand entry	Right
Collapse entry	Left

Description	Keyboard Shortcut
Toggle expand/collapse for entry	Enter
Move up/down one entry	Up, Down
Move to first entry	Home
Move to last visible entry	End
Block move vertical	PgUp, PgDn
Block move left	Ctrl+PgUp
Block move right	Ctrl+PgDn
Block extend vertical	Shift+PgUp, Shift+PgDn
Select all	Ctrl+A
Single select	Ctrl+Spacebar

Lists

Description	Keyboard Shortcut
Move within list	Up, Down
Move to beginning of list	Home
Move to end of list	End
Select all entries	Ctrl+A
Cut	Ctrl+X
Copy	Ctrl+C
Copy all entries	Ctrl+Shift+C
Paste	Ctrl+V

Tables

Description	Keyboard Shortcut
Move to next cell	Right Arrow
Move to previous cell	Left Arrow
Move to first cell in row	Home
Move to last cell in row	End
Move to first cell in table	Ctrl+Home
Move to last cell in table	Ctrl+End
Select all cells	Ctrl+A

Browser Tracer

The Browser Tracer is available from the Tools menu in Design Studio. The Browser Tracer can trace HTTP traffic in Design Studio as well as JavaScript execution for robots written with the Classic browser that was the default in pre-9.3 robots. The Browser Tracer is useful for performance tuning robots and figuring out workarounds for sites that do not work out-of-the-box.

Tracing

To start tracing, enable the Record button. While recording, especially if using JavaScript recording, things may run much slower than normal since vast amounts of data are collected. Make sure to disable the Record button once you have traced the traffic you wanted.

HTTP Trace

The HTTP trace shows HTTP traffic. Selecting a trace entry shows the details about that HTTP event in the detail view below the trace. The detail view shows the request and response headers, as well as the request and response data sent. Normally, only POST requests will contain request data.

Note Pending loads are shown in blue.

Blocking URL

You can block certain URLs by right-clicking an item in the HTTP list and selecting **Add URL to block**. The Configure URL Blocking Pattern dialog box opens for you to edit the URL pattern. See [URL Blocking](#) for more information.

JavaScript Trace

JavaScript tracing is only available for robots that use the Classic browser that was default in pre-9.3 robots. If you have a robot that uses the Default browser, the JavaScript tab is not available.

Below each JavaScript trace, the JavaScript source code for the currently selected trace entry is shown. When a trace entry is selected, the corresponding source code line is highlighted in the source view. The trace entry is the runtime result of the execution of the highlighted source code line. Each source code line may, of course, be executed multiple times, in which case multiple trace entries are produced, all corresponding to the same source code line.

Stepping through trace entries can help you understand how a piece of JavaScript code works.

It is possible to turn off tracing of JavaScript if you are only interested in the HTTP trace. You do this by clearing the Enable JavaScript Tracing check mark in the Trace menu.

Saving and Loading Trace Sessions

You can save trace sessions to load at a later time. A trace session contains both the Design Studio trace and the proxy trace, and both JavaScript and HTTP traces. Saving a trace session can be useful if it is large and you want to look at it in detail later, or if you want to mail it to someone else.

Note Bug reports submitted from Design Studio will automatically contain the current trace session, if any.

Note If downloaded content is changed by "Page Changes" or "JavaScript changes", the browser tracer adds an extra line where the changed content is shown in the response tab. The URL starts with `Rewritten`.

Variable Validation Errors

Validation errors can occur on variables using types that are changed, renamed, or deleted. This topic explains how to deal with these errors.

If a type used by a variable is missing, a validation error informing that the "type could not be found" is shown. Resolve the error by creating a type with the name of the missing type, or by opening the Configure Variable window and selecting another type for the variable.

A configuration problem with a type used by a variable can also result in a validation error on the variable informing that it has an "invalid type". This problem is solved by rectifying the problem with the type or selecting a different type for the variable from the Configure Variable window.

The validation error informing that some of the variable's initial/test values are "incompatible with its type" is a bit more subtle, and not as self-explanatory as the preceding errors. The error occurs if a variable has some initial/test values assigned to attributes and the variable's type is then changed such that one or more of the values can no longer be assigned to the attributes. This happens if the attribute is deleted from the type, or if the attribute type is changed so that the old assignment value is now incompatible. For instance, if an initial value is assigned to an attribute with the attribute type Short Text, but the variable type is changed so that the attribute now has the attribute type "Boolean," the old value can no longer be assigned to it. **To fix the problem**, open the Configure Variable window the now non-assigned values are shown and can be copied to other attributes. To clear the non-assigned values, and resolve the validation error, exit the Configure Variable window by clicking OK. A prompt appears, informing that the values will be discarded. After you click OK again, the validation error is resolved.

Supported Features in Excel

In this topic you can find both supported and unsupported features in Excel.

Formula Support

See <https://poi.apache.org/spreadsheet/formula.html> for details.

Features

Supported

- References: single cell & area, 2D & 3D, relative & absolute
- Literals: Number, text, boolean, error and array
- Operators: arithmetic and logical, some region operators
- Built-in functions: over 350 recognized, 280 evaluable
- Add-in functions: 3 from Analysis Toolpack
- Font color using the format string such as `[red]`
- Conditional font color, such as in the example where negative numbers are red: `#.##0;[Red]-#.##0`
- Date formatting

Unsupported

- Manipulating array/table formulas (In Excel, formulas that look like "{=...}" as opposed to "=...")
- Region operators: union, intersection
- Parsing of previously uncalled add-in functions
- Preservation of whitespace in formulas (when POI manipulates them)
- Font changes, for example bold, size, etc.
- Background color in cell

Function in POI

Supported Functions

ABS, ACOS, ACOSH, ADDRESS, AND, ASIN, ASINH, ATAN, ATAN2, ATANH, AVEDEV, AVERAGE, BIN2DEC, CEILING, CHAR, CHOOSE, CLEAN, CODE, COLUMN, COLUMNS, COMBIN, COMPLEX, CONCATENATE, COS, COSH, COUNT, COUNTA, COUNTBLANK, COUNTIF, COUNTIFS, DATE, DAY, DAYS360, DEC2BIN, DEC2HEX, DEGREES, DELTA, DEVSQ, DOLLAR, EDATE, ERROR.TYPE, EVEN, EXACT, EXP, FACT, FACTDOUBLE, FALSE, FIND, FLOOR, FV, HEX2DEC, HLOOKUP, HOUR, HYPERLINK, IF, IFERROR, IMAGINARY, IMREAL, INDEX, INDIRECT, INT, INTERCEPT, IPMT, IRR, ISBLANK, ISERROR, ISEVEN, ISLOGICAL, ISNA, ISNONTEXT, ISNUMBER, ISODD, ISREF, ISTEXT, LARGE, LEFT, LEN, LN, LOG, LOG10, LOOKUP, LOWER, MATCH, MAX, MAXA, MEDIAN, MID, MIN, MINA, MINUTE, MIRR, MOD, MODE, MONTH, MROUND, NA, NETWORKDAYS, NOT, NOW, NPER, NPV, OCT2DEC, ODD, OFFSET, OR, PERCENTILE, PI, PMT, POISSON, POWER, PPMT, PRODUCT, PV, QUOTIENT, RADIANS, RAND, RANDBETWEEN, RANK, RATE, REPLACE, REPT, RIGHT, ROMAN, ROUND, ROUNDDOWN, ROUNDUP, ROW, ROWS, SEARCH, SECOND, SIGN, SIN, SINH, SLOPE, SMALL, SQRT, STDEV, SUBSTITUTE, SUBTOTAL, SUM, SUMIF, SUMIFS, SUMPRODUCT, SUMSQ, SUMX2MY2, SUMX2PY2, SUMXMY2, T, TAN, TANH, TEXT, TIME, TODAY, TRIM, TRUE, TRUNC, UPPER, VALUE, VAR, VARP, VLOOKUP, WEEKDAY, WEEKNUM, WORKDAY, YEAR, YEARFRAC

Unsupported Functions

ACCRINT, ACCRINTM, AMORDEGRC, AMORLINC, AREAS, ASC, AVERAGEA, AVERAGEIF, AVERAGEIFS, BAHTTEXT, BESSELI, BESSELJ, BESSELK, BESSELY, BETADIST, BETAINV, BIN2HEX, BIN2OCT, BINOMDIST, CELL, CHIDIST, CHIINV, CHITEST, CONFIDENCE, CONVERT, CORREL, COUPDAYBS, COUPDAYS, COUPDAYSNC, COUPNCD, COUPNUM, COUPPCD, COVAR, CRITBINOM, CUBEKPIMEMBER, CUBEMEMBER, CUBEMEMBERPROPERTY, CUBERANKEDMEMBER, CUBESET, CUBESETCOUNT, CUBEVALUE, CUMIPMT, CUMPRINC, DATEDIF, DATESTRING, DATEVALUE, DAVERAGE, DB, DBCS, DCOUNT, DCOUNTA, DDB, DEC2OCT, DGET, DISC, DMAX, DMIN, DOLLARDE, DOLLARFR, DPRODUCT, DSTDEV, DSTDEVP, DSUM, DURATION, DVAR, DVARP, EFFECT, EOMONTH, ERF, ERFC, EXPONDIST, FDIST, FINDB, FINV, FISHER, FISHERINV, FIXED, FORECAST, FREQUENCY, FTEST, FVCHEDULE, GAMMADIST, GAMMAINV, GAMMALN, GCD, GEOMEAN, GESTEP, GETPIVOTDATA, GROWTH, HARMEAN, HEX2BIN, HEX2OCT, HYPGEOMDIST, IMABS, IMARGUMENT, IMCONJUGATE, IMCOS, IMDIV, IMEXP, IMLN, IMLOG10, IMLOG2, IMPOWER, IMPRODUCT, IMSIN, IMSQRT, IMSUB, IMSUM, INFO, INTRATE, ISERR, ISPMT, JIS, KURT, LCM, LEFTB, LENB, LINEST, LOGEST, LOGINV, LOGNORMDIST, MDTERM, MDURATION, MIDB, MINVERSE, MMULT, MULTINOMIAL, N, NEGBINOMDIST, NOMINAL, NORMDIST, NORMINV, NORMSDIST, NORMSINV, NUMBERSTRING, OCT2BIN, OCT2HEX, ODDFPRICE, ODDFYIELD, ODDLPRICE, ODDLYIELD, PEARSON, PERCENTRANK, PERMUT, PHONETIC, PRICE, PRICEDISC, PRICEMAT, PROB, PROPER, QUARTILE, RECEIVED, REPLACEB, RIGHTB, RSQ, RTD, SEARCHB, SERIESSUM, SKEW, SLN, SQRTPI, STANDARDIZE, STDEVA, STDEVP, STDEVPA, STEYX, SYD, TBILLEQ, TBILLPRICE, TBILLYIELD, TDIST, TIMEVALUE, TINV, TRANSPOSE, TREND, TRIMMEAN, TTEST, TYPE, USDOLLAR, VARA, VARPA, VDB, WEIBULL, XIRR, XNPV, YIELD, YIELDDISC, YIELDMAT, ZTEST

XML Data Mapper

Kapow version 9.1 and higher has an XML Data Mapper that allows convenient mapping of the data records specified by an XML document into variables of suitable structure.

Create a Data Mapping

1. Select the relevant XML element in the source view:

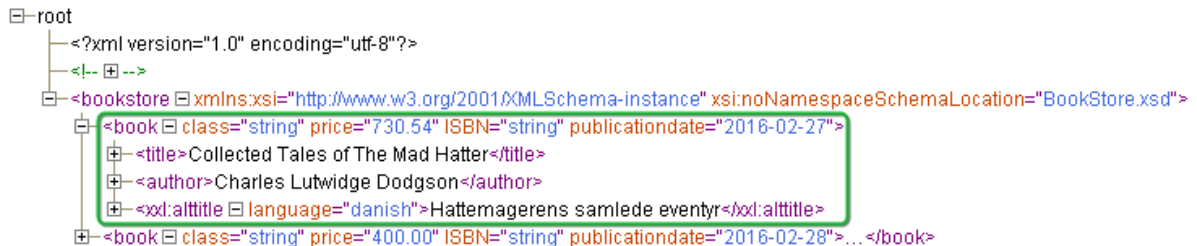

For details about issues related to selection, see [Selecting Data](#).

2. Configure the mapping using "Extract with XML Data Mapper" on the context menu of the selected XML element.
3. On the Extract list, select **With XML Data Manager**.
The XML Data Manager window appears.
 1. Map a source from the available list.
 2. In the Target Variable area, select a target variable and type.
 3. The bottom right area of the window is reserved for the configuration of details for individual entity mappings.
For more information, see [Configuring](#).

The step sequence that performs the mapping at runtime is automatically generated.
4. Click **OK**.
The steps are automatically created.



For more information, see [Auto-generating Steps](#).

Selecting Data

While the selection of data is easy, it is important to know how the selection and mapper interact.

In the Source column, select an XML element to map entities into variable attributes. Use the mapper to map the following entities to variable attributes:

- The attributes of the selected element itself. In the Sources column such attributes are listed as plain text names.
- The contents of sub-elements of the selected element that do not themselves contain sub-elements. In the Source column, such elements appear in an XML-like format where names are enclosed by < and >.

- The attributes of sub-elements of the selected element that do not themselves contain sub-elements. In the Source column, such attributes also appear in an XML-like format where both the enclosing element names and the attribute names are enclosed by < and >.

Note To activate the mapper for a section, at least one mappable element must be associated with the selected element.

Configuring

The configuration step is where most of the user interaction takes place. The configuration step is intended to identify an appropriate target variable attribute for each source entity that you wish to map. You are not required to map all available sources.

1. In the Target Variable section, select **Create a new Variable**.
2. Enter a name for the variable.
3. Select **Create a new Type**.
4. Enter a type name.

Attribute names matching the source entities are automatically generated and a mapping is suggested.

Source	Required	Target
class	<input type="checkbox"/>	<i>class</i>
price	<input type="checkbox"/>	<i>price</i>
ISBN	<input type="checkbox"/>	<i>ISBN</i>
publicationdate	<input type="checkbox"/>	<i>publicationdate</i>
<title>	<input type="checkbox"/>	<i>title</i>
<author>	<input type="checkbox"/>	<i>author</i>
<altitle>	<input type="checkbox"/>	<i>altitle</i>
<altitle xmlns:language>	<input type="checkbox"/>	<i>altitle_language</i>
		+ -

- To create a new variable from an existing type, select **Use Existing Type**. The system attempts to map source entities where the type prescribes attribute names that coincide with the names suggested by the sources.
- You can use an existing variable and associate it with a new type. Attribute names matching the source entities are automatically generated and mapping is suggested.
- You can use an existing variable and an existing type. The system will try to map sources automatically based on the attributes in the type.

Note When a new mapping is initiated, the system automatically attempts to make appropriate variable and type choices. Suggestions are made based on the XML element tag name . If a variable has the same name, the variable and type are suggested. If a matching variable exists but a type is named like the tag name, the system suggests creating a new variable using this type.

5. To map Entities, in the Source list, select an entity.
6. In the Target list, select an attribute.
A line connecting the source and the target shows the connection.
You can map a single source to more than one target.

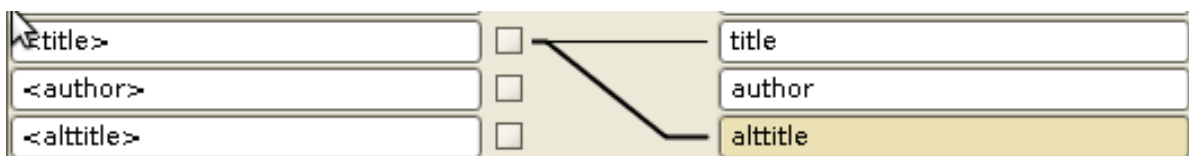

7. If the source entity is required for the overall mapping to be sound, select the check box next to the Source entity.
Associations can be dissolved as easily as they are created. To clear an association, hover the line close to the target and click the red cross that appears.
8. If no target attribute is suitable for the source entity is available, select the source element and click add .
The Add Attribute window appears.
9. Enter a name and type for the attribute.
To remove an attribute, select the attribute and click remove .

Note This only works with attributes added in the current invocation of the mapper, such as attributes that have not yet been persisted in the corresponding type file.

10. To configure the target attribute, select the attribute.
Configuration attributes appear.
You can associate data converters with the mapping, such that data may be brought into acceptable form.
You can select Trim Spaces if the source entity is an XML attribute.
 - You can change the target attribute name and type.
 - Associate data converters with the mapping such that data is brought into an acceptable form.
 - Select to clear Trim Spaces for XML attributes.

Auto-generating Steps

1. When the configuration of a data mapping is done, click **OK**.
The system auto-generates the actual steps required to perform the implied extractions and inserts the steps into the robot. The procedure always generates exactly one extract or extract tag attribute step for each association created in the mapper.

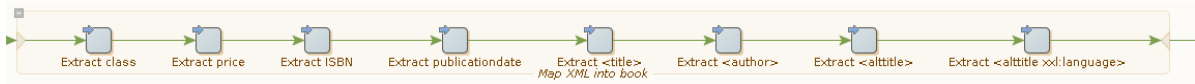

- Anchor the data mapping by a named tag identifying the original XML element you selected. If such a named tag does not exist, a Set Named Tag step is generated and inserted into the robot just before the actual data mapping.

Note Sometimes such a Set Named Tag is not necessary because a suitable named tag is already in place. This often occurs when the mapping is part of a loop.

Edit a Data Mapping

Once a data mapping is configured, you can use the data mapper to open and edit it. Since data mappings are associated with group steps, the ability to reopen the mapper is also connected to group steps.

- To open a data mapping, right-click a group step and select **Open XML Data Mapper**.

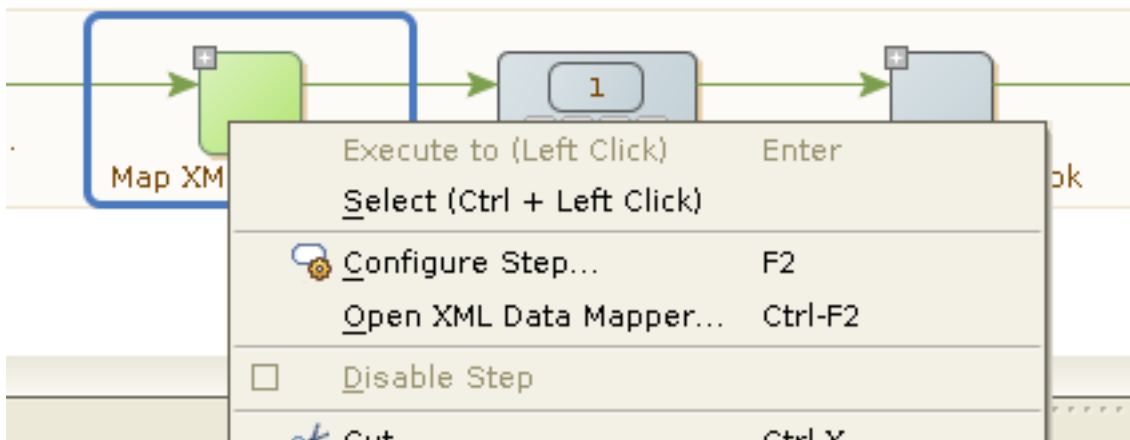

This will only work if the group step is the current step, that is, green. If it is not green, there may not be XML information to support the mapper.

Alternatively, you can open the mapper for a group step that is current on the associated step view and click **Open XML Data Mapper**

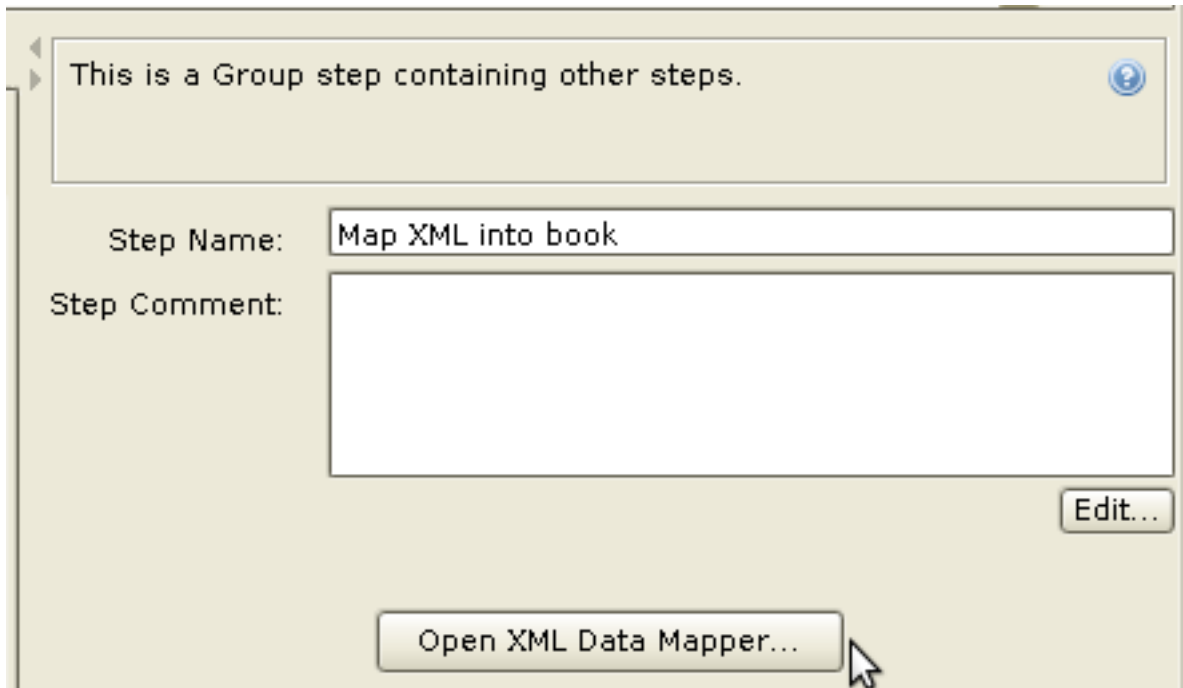

2. Once open, the mapper will behave exactly as described in [Create a Data Mapping](#).
3. Edit the data mapping steps manually if needed.
 Note that only certain changes are compatible with the XML data mapper. Opening a data mapping is subject to a number of conditions, essentially expressing that the group step MUST be a real data mapping.
 - The group step may not contain control structure in the form of branches, loops, or similar.
 - The group step must contain at least one *extract* or *extract tag attribute* step.
 - The extractions must all refer back to a named tag and it must be the same.
 - The extractions must all target attributes of the same variable.
 - For any given attribute of this variable, there may only be one extraction.
 - No extraction may use a tag finder where an asterisk '*' occurs.
 - All targeted attributes must exist in the underlying type.

URL Blocking

In the Configure URL Blocking Pattern window you can specify a URL blocking pattern and add this pattern to the robot's list of Blocked URL Patterns. Once you specify the pattern and click OK, the robot is re-executed.

You can use special symbols and edit the pattern in the Pattern Editor. See [Patterns](#) for more information.

RoboManager

RoboManager is a Kapow application for organizing and maintaining a large collection of robots. It is only used for managing robots created prior to Kapow version 7.2. For newer robots, we recommend that you use the logging and monitoring facilities available in the [Management Console](#).

With RoboManager, robots can be organized into robot groups, and you can monitor how your robots are running and hence detect robots that need to be fixed.

In essence, RoboManager is a database client to a database called the RoboManager database. All robot organizational information is stored in this database along with all the status messages that the robots generate when they are run. With RoboManager, you can search, view, and delete the content of the RoboManager database.

To learn about the new storage system and logging facilities that were introduced in Kapow version 7.2, please read through the storage system upgrade guide.

User Interface

This section contains information about some of the user interface features of RoboManager, including configuration of the search parameters in the various search views, as well as running robots.

Note that all of the search views use logical 'AND' conjunctions for their parameters.

Robot Search

The robot search is used for finding robot entries in the RoboManager database, as well as showing the status of the robots, based on their runs.

Parameters

The robot search view can be configured using the following parameters:

Robot Criteria

Robot Id

A comma-delimited list of one or more robot ids.

Default Robot URL

The text value for the default URL of a single robot to search for.

Robot Name

The name of the robot(s) to search for. Choose "Equals" if the name should match exactly. Choose "Contains" if the name of the robot(s) should only contain the text you enter. Choose "Empty" if the name should be empty.

Robot Group

Allows you to search based on robot groups. To enable this parameter, check the "Include in Search" option. Select the group or groups you wish to search for. Use the 'Ctrl' key to select multiple groups.

Run Criteria for Determining Robot Status

Run Host Name

The name of the host where the robot or robots were run. Use this option to define robot status based on runs from a single server.

Run Start Date

A timestamp range indicating which runs to use for calculating robot status, based on when the runs were started. The "From" field indicates the earliest time in the requested range, while the "To" field indicates the latest time in the requested range.

To include all runs after a specific time, enter a value for "From" and leave the "To" field blank.

Similarly, to only include runs before a specific time, enter a value in "To" and leave the "From" field blank.

Run Selection

Indicates which runs of the robot(s) should be used for calculating robot status. Choose from the following:

- "Use all runs" to use all runs of the robot(s)
- "Use all completed runs" to use only runs which have finished running
- "Use all unfinished runs" to use only runs which have not finished running
- "Use last runs only" to use only the most recent run of the robot(s)
- "Use last completed runs only" to use only the most recent finished runs of the robot(s)
- "Use last unfinished runs only" to use only the most recent unfinished runs of the robot(s)

Robot Run Search

The robot run search is used for finding robot runs in the RoboManager database.

The robot run search view can be configured using the following parameters.

Parameters

Robot Id

A comma-delimited list of one or more robot ids. Use this option to specify which runs should be searched for based upon the robot that was run.

Robot Group

Allows you to search for runs based on the robot groups of the robot(s). To enable this parameter, check the "Include in Search" option. Select the group or groups you wish to search for. Use the 'Ctrl' key to select multiple groups.

Run Id

A comma-delimited list of one or more robot run ids.

Run Host Name

The name of the host where the robot runs were executed.

Run Start Date

A timestamp range indicating which runs to use for finding robot runs, based on when they were started. The "From" field indicates the earliest time in the requested range, while the "To" field indicates the latest

time in the requested range. To include all runs after a specific time, enter a value for "From" and leave the "To" field blank. Similarly, to only include runs before a specific time, enter a value in "To" and leave the "From" field blank.

Run Selection

Indicates which robot runs should be displayed. Choose from the following:

- "Show all runs" to show all robot runs
- "Show all completed runs" to show only runs which have finished running
- "Show all unfinished runs" to show only runs which have not finished running

Message Search

The message search is used for finding message entries in the RoboManager database.

Parameters

The message search view can be configured using the following parameters:

Robot Id

A comma-delimited list of one or more robot ids. Use this option to specify a search for messages generated only by the indicated robot(s).

Run Id

A comma-delimited list of one or more robot run ids. Use this option to specify a search for messages generated only by the indicated robot run(s).

Description

The description text of messages to search for. Choose "Equals" if the description should match exactly. Choose "Contains" if the description of the message should only contain the text you enter. Choose "Empty" if the description should be empty.

Message Date

A timestamp range indicating which messages to find based on when they were generated. The "From" field indicates the earliest time in the requested range, while the "To" field indicates the latest time in the requested range. To include all messages after a specific time, enter a value for "From" and leave the "To" field blank. Similarly, to only include messages before a specific time, enter a value in "To" and leave the "From" field blank.

Message Type

Allows you to search for messages based on message type. To enable this parameter, check the "Include in Search" option. Select one or more of the following message types:

- "Object_Handling_Error" for errors from the Return Object action (e.g. an error trying to save an object to database storage because of a missing required attribute value)
- "Robot_Execution_Error" for errors in the running of the robot (e.g. an error in a tag finder due to the change of a page layout)
- "Program_Error" for errors internally in Kapow -- please report these to support@kapowsoftware.com
- "Object_Handling_Warning" for warnings from the Return Object action
- "Object_Handling_Info" for informational messages from the Return Object tag processor (e.g. when an object is stored to the database)

- "Robot_Execution_Info" for informational messages from the normal running of the robot

Running Robots

The robot run view allows the user to manually run a robot from a file. Once the run is configured, the robot can be started by pressing 'Run'.

Properties

The robot run view can be configured using the following properties:

Robot URL

The ".robot" URL of the robot to run.

Environments

The [environments](#) that should be used for running the specified robot.

RoboServer

RoboServer is the Kapow application for running robots as a service to clients. Once started, RoboServer accepts requests from clients, such as robot execution requests, and sends back responses, such as the objects that a robot extracted during its execution.

For an in-depth description of the RoboServer, please see *Kapow Administrator's Guide*.

Start RoboServer

You can start the RoboServer using the following actions.

- Click the RoboServer program icon (or the Start Management Console program icon which starts both the Management Console and RoboServer).
- Start the RoboServer from the command line.
- Run the server as a service. For more information about running RoboServer as a service, see [Starting Servers Automatically](#).

To invoke RoboServer from the command line, open a Command Prompt window, navigate to the `bin` folder in the `Kapow` installation folder and type:

```
RoboServer
```

If all necessary parameters are specified in the [roboserver.settings](#) configuration file, the RoboServer starts.

If any of the necessary parameters is missing, the RoboServer specifies an error and displays the usage help and available parameters.

RoboServer Parameters

The command line for starting a RoboServer may include the following parameters:

```
RoboServer [-cl <arg>] [-cpuThreads <arg>] [-h]
           [-maxConcurrentRobots <arg>] [-maxQueuedRobots <arg>] [-MC] [-mcUrl
           <arg>] [-p <arg>] [-pauseAfterStartupError] [-s <arg>] [-sslPort
           <arg>] [-v] [-V]
```

Regardless of how you start RoboServer, it accepts the parameters in the following table. Note that you can edit all the parameters in the RoboServer Settings utility. See [RoboServer Configuration](#) for more details.

Parameter	Description
-cpuThreads <arg>	Specifies the number of CPU threads to use.
-h --help	Displays help.
-maxConcurrentRobots <arg>	Specifies the maximum number of concurrently executed robots.
-maxQueuedRobots <arg>	Specifies the maximum number of robots in the queue.
-mcUrl <arg>	Specify which Management Console to register to in the following format: http[s]:// <username>:<password>@<hostname>:<port number> Example: -mcUrl http:// admin:password@localhost:8080/ ManagementConsole/
-pauseAfterStartupError	
-v -verbose	This optional parameter causes RoboServer to output status and runtime events.
-V -version	This optional parameter causes RoboServer to output the version number, and then exit.
-MC --scheduler	This optional parameter triggers the Management Console to be started as part of RoboServer. The Management Console runs on an embedded web server configured through the Settings application.
-cl --cluster <arg>	This optional parameter automatically registers the roboServer with the specified cluster on the Management Console. In the following example the roboServer registers itself with the <i>Production</i> cluster. Example: -cl Production Example: -mcUrl http:// admin:password@localhost:8080/ ManagementConsole/ -cl Production

Parameter	Description
-s <service-name:service-parameter> -service <service-name:service-parameter>	This parameter specifies a RQL or JMX service that RoboServer should start. This parameter must be specified at least once, and may be specified multiple times to start multiple services in the same RoboServer. The available services depend on your installation. Example: -service socket:50000 Example: -service jmx:50100
-p <port-number> -port <port-number>	This is shorthand for calling -s socket:<port-number> Example: -port 50000
-sslPort <arg>	This is a shorthand for writing -s ssl:<port number>
Available services	
-service socket:<portNumber>	<portNumber>: The port number for the socket-service to listen on.
-service ssl:<portNumber>	<portNumber>: The port number for the socket-service to listen on.
-service jmx:<jmx_port_Number> , <jmx_rmi_url>	<jmx_port_Number>: The port number for the JMX service to listen on. <jmx_rmi_url>: Optional RMI host and port for the JMX service. Use if you need to connect through a firewall. Example: example.com:51001

Note that to set passwords, you must either use the RoboServer Settings utility or the ConfigureRS tool. For more information, see [RoboServer Configuration](#) and [RoboServer Configuration - Headless Mode](#).

Starting Servers Automatically

If your installation includes any server functionality, you can configure it to start the servers automatically.

When referring to "server functionality", we mean RoboServers and the Management Console (license server). In fact these two components are provided by the RoboServer, depending on the arguments supplied to it when it starts.

The RoboServer Parameters topic contains a detailed description of the command-line arguments for the RoboServer program. To enable the RoboServer program to execute robots, specify the `-service` argument. Similarly, the `-MC` argument enables the Management Console functionality (see Management Console (License Server) in the Installation Guide).

The following topics details how to make RoboServer start automatically on Windows and Linux.

Shutting Down RoboServer

RoboServer can be shut down using the command line tool ShutDownRoboServer. Run ShutDownRoboServer without arguments to see the various options for how to shut down the server, particularly how to handle any robots currently running on the server.

RoboServer Configuration

You can configure RoboServer through the RoboServer Settings application. RoboServer Settings can be started from the Windows Start menu.

Settings Main Window

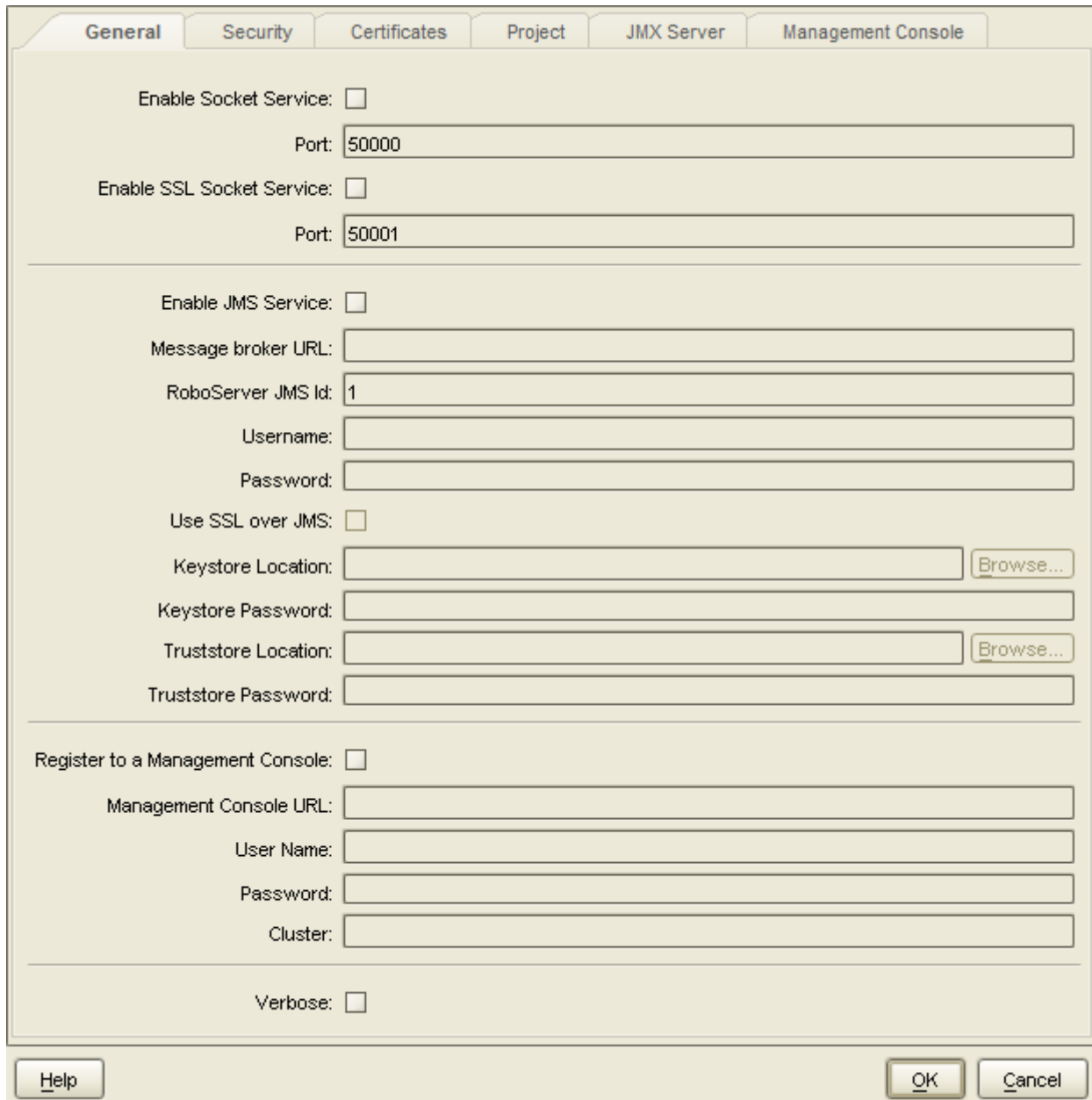

The screenshot displays the RoboServer Settings application window with the 'General' tab selected. The window has a title bar and several tabs: 'General', 'Security', 'Certificates', 'Project', 'JMX Server', and 'Management Console'. The 'General' tab contains the following configuration options:

- Enable Socket Service:** (unchecked)
- Port:** 50000
- Enable SSL Socket Service:** (unchecked)
- Port:** 50001
- Enable JMS Service:** (unchecked)
- Message broker URL:** [Empty text box]
- RoboServer JMS Id:** 1
- Username:** [Empty text box]
- Password:** [Empty text box]
- Use SSL over JMS:** (unchecked)
- Keystore Location:** [Empty text box] with a 'Browse...' button
- Keystore Password:** [Empty text box]
- Truststore Location:** [Empty text box] with a 'Browse...' button
- Truststore Password:** [Empty text box]
- Register to a Management Console:** (unchecked)
- Management Console URL:** [Empty text box]
- User Name:** [Empty text box]
- Password:** [Empty text box]
- Cluster:** [Empty text box]
- Verbose:** (unchecked)

At the bottom of the window, there are three buttons: 'Help', 'OK', and 'Cancel'.

Using this application, you can configure the following:

- General: Socket service options, enable and configure JMS Service options, Management Console connection options, and the Verbose option.
- Security: Security settings such as authentication and permissions.
- Certificates: The use of certificates.
- Project: The location of the default v project.
- JMX Server: The JMX server.
- Management Console: Configuration of the embedded Management Console.

After changing any of the settings, click OK to store the new settings, and then restart any RoboServers that are running, to make the changes take effect.

Starting from Kapow version 10, all RoboServers must auto register to the Management Console. Therefore, the URL and credentials for the Management Console along with the cluster name must be specified when starting the RoboServer (either at the command line or using the RoboServer Settings application).

Kapow contains several command-line tools to help you modify the settings in batch mode. For example, you can create several users with specified permissions. See [Configuring RoboServer in Headless Mode](#).

If you need to change the maximum amount of RAM that RoboServer can use, see [Change the RAM Allocation in the Administrator's Guide](#).

RoboServer Configuration - Headless Mode

Kapow ships with several utilities to configure your RoboServer from a command line. The utilities are located in the `bin` subfolder of the Kapow installation folder. Note that the configuration files are user-dependent and stored in the user folder. For more information, see the [Important Folders](#) topic in the [Kapow Installation Guide](#).

- `ConfigureRS`: Sets the JMX password and the Management Console password in the RoboServer settings file (`roboserver.settings`).
- `ConfigureMC`: Sets Management Console administrator and certificate passwords in the `mc.settings` file.
- `ConfigureRSUser`: Adds and removes users and updates user credentials in the `rsusers.xml` file. Information in this file is used to authenticate API requests.

For help on usage, run utilities with an `-h` option.

To set a connection to the Management Console that the RoboServer will register to, type the following command:

```
ConfigureRS -mcUrl http://admin:password@localhost:8080/ManagementConsole/
```

To create a user `user1` with `Password1` password and all permissions type the next command:

```
ConfigureRSUser user1 Password1 -a
```

To enable authentication of API requests, you must open `rsusers.xml` and change the `enabled` attribute to `true`, as shown in the following example.

Sample rsusers.xml configuration file

```
<?xml version="1.0" encoding="UTF-8"?>
  <userConfiguration enabled="true">
    <users>
      <user username="user1" password_hash="20c7628c31534b8718a1da00435505e4262e3f4dc305">
        <startRobot/>
        <stopRobot/>
        <shutdownRoboServer/>
      </user>
    </users>
  </userConfiguration>
```

Sample roboserver.settings configuration file

```
# Settings file for RoboServer. Some configurations contains encrypted passwords and should not
  be edited by hand,
  these should be modified using dedicated commandline tools.

# The directory of use on RoboServer when the API used the DefaultRoboLibrary. On windows \ must
  be escaped like this
c:\\\\users\\AppData\\Local\\Kapow\\...
defaultProject = /home/mikael.nilsson/Kapow/trunk

# Should RoboServer be allowed to access the fileSystem, or call commands/scripts. Values: true/false
sec_allow_file_system_access = false

# Will RoboServer accept JDBC drivers sent from the Management Console. Values: true/false
sec_accept_jdbc_drivers = true

# Should RoboServer log all loaded URLs to the log4j audit log. Values true/false
sec_log_http_traffic = false

# If enabled RoboServer will check credentials for API requests. Values: true/false
sec_authenticate_api_requests = false

# If enabled RoboServer generate an error when accessing a https site without a valid
  certificate. Values: true/false
cert_verify_https_certificates = false

# If enabled, RoboServer will only allow SSL connections from trusted client. Values true/false
cert_verify_api_certificates = false

# Configures if the the JMX service should be enabled
enable_jmx = false

# The port number for the JMX service to listen on.
jmx_port_Number = 50100

# If enabled, input for robots is exposed through JMX. Values: true/false
jmx_show_inputs = true

# Heartbeat notification interval, in seconds
jmx_heartbeat_interval = 0

# Configure if JMX should use RMI
enable_jmx_rmi = false

# Optional RMI host and port for the JMX service. Use if you need to connect through a firewall.
  Example: example.com:51001
jmx_rmi_url =

# Enables authentication for JMX requests. Values: true/false
jmx_enable_authentication = true

# The user-name used for JMX authentication
jmx_username =

# The password used for JMX authentication. This should be created using the ConfigureRS command
  line tool.
```

```

jmx_password =

# Configures if the socket service should be enabled
enable_socket_service = false

# Configures which port the RoboServer should be listening on
port = 50000

# Configures if the ssl socket service should be enabled
enable_ssl_socket_service = false

# Configures which ssl port the RoboServer should be listening on
ssl_port = 50001

# Configures if the JMS service should be enabled
enable_jms_service = false

# Configures which id the RoboServer should have when running JMS
jms_id = 1

# Configures the URL of the message broker when running JMS
broker_url =

# Configures if the RoboServer should register to a Management Console
enable_mc_registration = false

# Specify which Management Console to register to formatted as: http[s]://<hostname>:<port
  number>
mc_URL =

# The user name to use for authentication to the Management Console
mc_username =

# The password to use for authentication to the Management Console
mc_password =

# Specifies which cluster the RoboServer should be registered to
cluster =

# Causes RoboServer to output status and runtime events
verbose = false

```

Sample mc.settings configuration file

```

# Settings file for Management Console. Passwords should not be edited by hand, but using the
'ConfigureMC' command line utility.

# Should the MC web-server start a HTTP listener. Values true/false
mc_http = true

# Configures the port of the http listener.
mc_http_port = 50080

# Should the MC web-server start a HTTPS listener. Values true/false
mc_https = false

# Configures the port of the HTTPS listener.
mc_https_port = 50443

# Password for the certificate used by the HTTPS listener. This should be created using the
ConfigureMC command line tool.
mc_https_cert_password = 3W2MTrL/b2k=

# Enables MC internal user management, to support multi user scenarios. Values: true/false
mc_enable_usermanagement = true

# The user-name of the MC super user.
mc_admin_user =admin

# The passwordHash of the MC super user. This is a salted SHA-256 hash.

```

```
mc_admin_password
=7800451255702ef8ae5f5fa0337833059d80b81d5af5872bdeafed230bab479896b6df4f63b25a24

# Configures which hosts are allowed to upload JDBC jar files to MC. Values: NONE, LOCALHOST,
ANY_HOST
mc_allow_jdbc_upload = LOCALHOST
```

Management Console

The Management Console is a web-based application for monitoring and managing your Kapow installation, using the Management Console you can do the following:

- Enable collaboration and sharing using the repository.
- Manage user roles and permissions, and centrally administer the solution.
- Advanced scheduling of robots from the repository.
- Browse extracted data and export to MS Excel.
- Access detailed logs of production results and errors.
- Graphical dashboard for monitoring RoboServer health and resource usage.
- One-Click deployment of robots from Design Studio to the repository.

For more details refer to the Management Console documentation or the Management Console Tutorial.

Other Topics

This section contains reference help on some of the other important concepts that are used in the Management Console.

Cron Schedule

A "cron" schedule is made up of six or seven sub-fields that together describe when the robots should be run. The sub-fields are separated with one or more spaces, and represent:

1. Seconds
2. Minutes
3. Hours
4. Day-of-Month
5. Month
6. Day-of-Week
7. Year (optional field)

An example of a complete cron schedule is "0 0 12 ? * WED", which means "every Wednesday at 12:00 pm".

Individual sub-fields can contain ranges and/or lists. For example, the Day-of-Week field in the previous example (that is, "WED") could be replaced with "MON-FRI", "MON, WED, FRI", or even "MON-WED,SAT".

Wild-cards (the "*" character) can also be used, meaning "every possible value of this field". For example, the "*" character in the Month field of the previous example would mean "every month". A "*" in the Day-of-Week field would obviously mean "every day of the week".

The set of valid values for each field is:

- Seconds: The numbers 0 to 59.
- Minutes: The numbers 0 to 59.
- Hours: The numbers 0 to 23.
- Day-of-month: The numbers 1 to 31 (but be careful about how many days there are in a given month).
- Month: The numbers 1 to 12, or the strings JAN, FEB, MAR, APR, MAY, JUN, JUL, AUG, SEP, OCT, NOV and DEC.
- Day-of-week: The number 1 to 7 (1 is Sunday), or the strings SUN, MON, TUE, WED, THU, FRI and SAT.
- Year: Any number.

In addition, a number of special characters may be used:

	Definition
/	Specifies increments to values. For example, if you put "0/15" in the Minutes field, it means "every 15 minutes, starting at minute zero". If you use "3/20" in the Minutes field, it means "every 20 minutes during the hour, starting at minute three" - in other words, the same as specifying "3,23,43".
?	Allowed only in the Day-of-Month and Day-of-Week fields, and means "no specific value". This is useful when you need to specify something in one of these two fields, but not the other. See the examples below for clarification.
L	Allowed only in the Day-of-Month and Day-of-Week fields. "L" is short-hand for "last", but its meaning differs between the two fields. In the Day-of-Month field, "L" means "the last day of the month" - day 31 for January, day 28 for February on non-leap years etc. If used in the Day-of-Week field by itself, it simply means "7" or "SAT", but if used in the Day-of-Week field after another value, it means "the last xxx day of the month" - for example "6L" or "FRIL" both mean "the last Friday of the month". When using the "L" character, it is important not to specify lists or ranges of values, as you'll get confusing results.
#	Used in the Day-of-Week field to specify "the nth" XXX weekday of the month. For example, the value of "6#3" or "FRI#3" means "the third Friday of the month".
W	Specifies the weekday (Monday-Friday) nearest the given day. As an example, if you were to specify "15W" as the value for the Day-of-Month field, the meaning is: "the nearest weekday to the 15th of the month".

Examples

Cron schedule	Explanation
0 0 12 * * ?	Fire at 12pm (noon) every day
0 15 10 ? * *	Fire at 10:15am every day
0 15 10 * * ?	Fire at 10:15am every day
0 15 10 * * ? *	Fire at 10:15am every day
0 15 10 * * ? 2005	Fire at 10:15am every day during the year 2005

Cron schedule	Explanation
0 * 14 * * ?	Fire every minute starting at 2pm and ending at 2:59pm, every day
0 0/5 14 * * ?	Fire every 5 minutes starting at 2pm and ending at 2:55pm, every day
0 0/5 14,18 * * ?	Fire every 5 minutes starting at 2pm and ending at 2:55pm, AND fire every 5 minutes starting at 6pm and ending at 6:55pm, every day
0 0-5 14 * * ?	Fire every minute starting at 2pm and ending at 2:05pm, every day
0 10,44 14 ? 3 WED	Fire at 2:10pm and at 2:44pm every Wednesday in the month of March.
0 15 10 ? * MON-FRI	Fire at 10:15am every Monday, Tuesday, Wednesday, Thursday and Friday
0 15 10 15 * ?	Fire at 10:15am on the 15th day of every month
0 15 10 L * ?	Fire at 10:15am on the last day of every month
0 15 10 ? * 6L	Fire at 10:15am on the last Friday of every month
0 15 10 ? * 6L	Fire at 10:15am on the last Friday of every month
0 15 10 ? * 6L 2002-2005	Fire at 10:15am on every last Friday of every month during the years 2002, 2003, 2004 and 2005
0 15 10 ? * 6#3	Fire at 10:15am on the third Friday of every month

Filtering

Filter field in the Robots, Types, Snippets, Resources, and Databases tabs under Repository helps you to filter a list of items to view by their names and path.

Note the following rules when applying filters:

- ? matches a single character, * matches zero or more characters
- When you type a search string without a forward slash and without any wildcard characters, the search is performed as a substring matching the name of the items. For example, the search string "foo" would match the robots `foo` and `foobar` regardless of the folder they are in.
- When you type a search string without a forward slash but with one or more wildcard characters, the search is performed as pattern matching the full name of the item. For example, "foo*" would match the robots `foo` and `foobar` regardless of the folders they are in, but would not match `xxxfoo`. The search string "foo?ar" would match the robot `foobar`.
- When you type a search string containing a forward slash, the search is performed to match the full path of the items, that is folder plus name. For example, the search string "sub1/foo" would match `sub1/foo`, but not `sub1/foobar`. The search string "sub1/foo*" would match both `sub1/foo` and `sub1/foobar`.

Environments

Environments have been deprecated, and is only included for backwards compatibility. This information is only relevant to users who were running robot prior to version 7.2. For storing data in databases, see [Storing data in databases](#). Logging is now configured in [Settings](#).

This describes the legacy environments.

When a robot is run, the environment list must contain the Common Robot Environment, exactly one Robot Info Environment, exactly one Storage Environment, and exactly one Message Environment. If the robot requires input, then the environment list must also contain exactly one Input Configuration.

Note, however, that if you execute a robot on RoboServer, you can leave out any environment to get the default behavior.

Example

To run a robot that stores the extracted objects and generated status messages in a database, and retrieves the robot info from the RoboManager database, use an environment list containing the following environments: Common Robot Environment, Database Robot Info Environment, Database Storage Environment, and Database Message Environment.

If the robot requires input, then add a Input Configuration containing the input variables needed by the robot in order to execute.

Robot Info Environments

Message Environments have been deprecated. Logging is now configured in the cluster settings, see the cluster settings documentation.

A Robot Info Environment is responsible for providing information about a robot, such as its name and run id. A robot run requires the presence of exactly one Robot Info Environment. However, when executing a robot on RoboServer, this environment can be left out to get the default behavior.

There are two kinds of Robot Info Environments:

- [Database Robot Info Environments](#)
- [Simple Robot Info Environments](#)

Database Robot Info Environment

Message Environments have been deprecated. Logging is now configured in the cluster settings, see the cluster settings documentation. You may also want to check New Storage System in 7.2, if you are storing objects in a database.

The Database Robot Info Environment is a Robot Info Environment that provides the robot info as retrieved from the RoboManager database.

Properties

The Database Robot Info Environment can be configured using the following properties:

Database Name

The name of the RoboManager database from which to retrieve the robot info.

Simple Robot Info Environment

Message Environments have been deprecated. Logging is now configured in the cluster settings, see the cluster settings documentation.

The Simple Robot Info Environment is a Robot Info Environment that provides the robot info provided as part of the configuration of the environment.

The Simple Robot Info Environment is typically used when no RoboManager database is available.

Properties

The Simple Robot Info Environment can be configured using the following properties:

Robot Name

The robot name.

Robot Run Id

he robot run id as an integer

Storage Environments

Storage environments have been deprecated, to upgrade see New Storage System in 7.2. You may also want to read Storing data in databases. To store data in files see Write File.

A Storage Environment is responsible for storing an extracted object. The run of a robot requires the presence of exactly one Storage Environment. However, when executing a robot on RoboServer, this environment can be left out to get the default behavior.

There are three kinds of Storage Environments:

- [Database Storage Environment](#)
- [File Storage Environment](#)
- [Multiple Files Storage Environment](#)

Database Storage Environments

Storage environments have been deprecated, to upgrade see New Storage System in 7.2. You may also want to read Storing data in databases. To store data in files see Write File. The Database Storage Environment is a Storage Environment that stores extracted objects in a database.

Properties

The Database Storage Environment can be configured using the following properties:

Database Name

This property specifies the name of the database in which to store the extracted objects.

File Storage Environments

Storage environments have been deprecated, to store data in files see Write File The File Storage Environment is a Storage Environment that stores the extracted objects in a file.

Properties

The File Storage Environment can be configured using the following properties:

File Name

The name of the file in which to store the extracted objects.

File Format

The file format in which to store the extracted objects.

File Encoding

The file encoding of the generated file. Not relevant for binary files.

Multiple Files Storage Environment

Storage environments have been deprecated, to store data in files see Write File The Multiple Files Storage Environment is a Storage Environment that stores attributes of the extracted objects in multiple files.

Example

Say you want to save images from a web site in files using a robot. You could do this by first creating an output object that has the following attributes: fileName (of type Short Text) and content (of type Image). In your robot you extract the images (using a **Load Data** action) into the content attribute and place a relative file name in the fileName attribute, e.g. images/myImage.gif (this name can almost always be constructed from the value of the src attribute of the -tag in the HTML). When you configure the Multiple Files Storage Environment you set the Root Folder to some folder in your file system on the machine where RoboServer is running, e.g. C:\download. You set the value of File Name Attribute to fileName and the value of File Content Attribute to content. If you run your robot and the fileName attribute of the object it returns contains the value images/myImage.gif the image will be saved in the file: C:\download\images\myImage.gif

Properties

The Multiple Files Storage Environment can be configured using the following properties:

Root Folder

The location in the local file system relative to which the files will be placed.

File Name Attribute

The name of the attribute in the output object which contains the file name.

File Content Attribute

The name of the attribute in the output object which contains the contents of the file.

File Encoding

The file encoding of the generated file. Not relevant for binary files.

Message Environments

Message Environments have been deprecated. Logging is now configured in the cluster settings, see the cluster settings documentation.

A Message Environment is responsible for handling robot generated status messages. The run of a robot requires the presence of exactly one Message Environment. However, when executing a robot on RoboServer, this environment can be left out to get the default behavior.

There are four kinds of Message Environments:

- [Aggregate Message Environment](#)
- [Database Message Environment](#)
- [Email Message Environment](#)
- [File Message Environment](#)

Aggregate Message Environments

Message Environments have been deprecated. Logging is now configured in the cluster settings, see the cluster settings documentation.

The Aggregate Message Environment is a Message Environment that itself contains zero or more other Message Environments.

The Aggregate Message Environment can be used to e.g. both store the messages in a database and send an email if any errors occur.

Properties

The Aggregate Message Environment can be configured using the following properties:

Environments

This property specifies the contained Message Environments.

Database Message Environment

Message Environments have been deprecated. Logging is now configured in the cluster settings, see the cluster settings documentation.

The Email Message Environment is a Message Environment that sends an email if any error messages were generated during the robot execution.

Properties

The email will contain information about the first 50 errors that occurred; the email is in HTML format

The Email Message Environment can be configured using the following properties:

Email Address

The email address that the email is sent to.

Mail Server

The mail server to use when sending the email.

Email Message Environment

Message Environments have been deprecated. Logging is now configured in the cluster settings, see the cluster settings documentation.

The Email Message Environment is a Message Environment that sends an email if any error messages were generated during the robot execution.

Properties

The email will contain information about the first 50 errors that occurred; the email is in HTML format

The Email Message Environment can be configured using the following properties:

Email Address

The email address that the email is sent to.

Mail Server

The mail server to use when sending the email.

File Message Environment

Message Environments have been deprecated. Logging is now configured in the cluster settings, see the cluster settings documentation. The File Message Environment is a Message Environment that stores the robot generated status messages in a file.

Properties

The File Message Environment can be configured using the following properties:

File Name

The name of the file in which to store the messages.

File Encoding

The file encoding

Append

Checked if the messages should be appended to the file, otherwise the file will be overwritten.

Input Configuration

Allows you to provide input variables when executing a robot with the debugger.

Properties

An Input Configuration can be configured using the following properties:

Input Variables

The input variables to pass on to the robot.

Runtime Configuration

The Runtime Configuration enforces limitations on e.g. total robot execution time.

Properties

Bypass Refind Object

This property specifies whether the Refind Object action should be bypassed. If this property is set, then the Refind Object action is bypassed, that is, ignored.

Max. Execution Time

This property sets an upper limit on the total robot execution time. If the robot does not complete within this time limit, then an error message is generated and the robot is stopped. The property value is specified in seconds.

Max. Time Between Object Extractions

This property sets an upper limit on the time between object extractions. If the robot has not extracted an object within this time limit, then an error message is generated and the robot is stopped. The property value is specified in seconds.

Min. Object Extractions Limit

This property sets a lower limit on the number of object extractions. If the robot extracts less objects than indicated by this property, then an error message is generated.

Max. Object Extractions Limit

This property sets an upper limit on the number of object extractions. If the robot extracts more objects than indicated by this property, then an error message is generated or the robot is stopped.

Stop at Max. Extractions Limit

Should the robot be stopped when upper limit of object extractions is reached or should we only generate an error message.

Max. JavaScript Instructions

The maximum number of JavaScripts instruction the robot is allowed to execute. If the limit is reached the robot is stopped.

Max. Http Requests

The maximum number of Http requests the robot is allowed to load. If the limit is reached the robot is stopped.

Max. Sent Emails

The maximum number of emails the robot is allowed to send. If the limit is reached the robot is stopped.

Max. Loaded Bytes

The maximum number of bytes the robot is allowed to load. If the limit is reached the robot is stopped.

Max. Executed Steps

The maximum number of steps the robot is allowed to execute. If the limit is reached the robot is stopped.

Java API

A copy of the Java API documentation is installed under the API folder in your Kapow installation folder, for example `C:\Program Files\Kapow 10.0.0\API`. Open the `Overview.html` file in the API folder and browse for the topic you are interested in.

You can also read the Developer's Guide that contains information about programming for Kapow. The guide can be accessed in the **Kapow > Documentation** on the Start menu.

Using Proxy Services

Some IP proxy providers are beginning to offer built-in IP rotation services. Although this is convenient, it is not always a useful service for those who need IP proxies.

Kapow does not recommend using an IP-rotation model where the proxy provider rotates the IP at random or pre-set times, because not all web sites are able to or even allow maintaining a browser session across an IP address change.

On the open Internet, IP rotation can work just fine, because the typical browser socket connection has a very short life and the web site does not check the source IP address. Many web sites and shops implement the most basic session management. With the increase in cyber-threats and focus on security, many web sites are increasing their security level and adding IP address monitoring. It is a good practice for web servers to detect and prevent in-session IP address changes for protection against Man-in-the-Middle attacks. This is why all web banking sites and many other commercial and financial services sites with user login are implementing protection against in-session IP address changes.

Since changing the IP address is likely to break the session in progress with the web-server, you cannot arbitrarily rotate IP addresses while running robots. The best way to use proxies effectively is to control the proxy from within the robot, for instance by using the [Change Proxy](#) step, or by using web services provided by the proxy service.

If the rotation is done in the robot, with consideration of the remote website, in a way the transactions are made within an IP address session, the robot should work fine.

See also:

- [Change Proxy](#) step
- [Proxy Servers](#) in Design Studio settings
- Configuring [Proxy Servers](#) in Management Console